

中國, 香港及澳門代理商
Agent of China, HK & Macau

A N E L

APEX NOBLE EQUIPMENT LTD.

雅麗盈設備有限公司

香港荃灣柴灣角街95號華俊工業中心18樓05室

Unit 5, 18/F., Wah Chun Industrial Centre,

95 Chai Wan Kok Street, Tsuen Wan, New Territories, Hong Kong

Mobile: 852-94505051, 853-62839652, 86-14715675669

Tel: 852-36901333, 36901338 Fax: 852-36901339

Website: www.anel.com.hk



CATALOGUE & PRICE LIST



KATALOG UND PREISLISTE





forcar[®]

CARRELLI PLURISERVICE - MULTISERVICE TROLLEYS
CHARIOTS MULTI-SERVICES - MEHRSERVICE WAGEN

2015/16

Carrelli di servizio in legno, Mobili di servizio - Wodden service trolleys, Serving furniture Chariots de service en bois, Meubles de service - Servicewagen aus Holz, Servicemöbel	pag. 3
Carrelli di servizio inox - Stainless steel service trolleys - Chariots de service inox - Servicewagen aus Edelstahl	pag. 41
Carrelli ed espositori refrigerati, Carrelli, Tavole, Distributori Termici, Carrelli termici bagnomaria Refrigerated trolleys and display cases, Trolleys, Tables, Thermal distributors, Thermal double boiler trolleys Chariots et présentoirs réfrigérés, Chariots, Tables, Distributeurs thermiques, Chariots thermiques bain-marie Wagen und gekühlter Ausstellungswagen, Thermo, Wagen, Tische, Ausgabevorrichtungen, Thermowagen für wasserbäder	pag. 57
Carrelli ed espositori refrigerati in legno, Espositore caldo bagnomaria con cupola, Bolliti e arrostiti Refrigerated wooden trolleys and display cases, Bain-marie warmed display case with dome, Roast and boiled meat trolley Chariots et présentoirs réfrigérés en bois, Présentoir chauffé bain-marie avec cloche, Chariot pour bouillis et rotis Wagen und gekühlter Ausstellungswagen aus Holz, Warme wasserbadausstellung mit kuppel, Wagen für Kochfleisch und Braten	pag. 69
Tavole calde da banco, Piani caldi inox, lampade a raggi infrarossi, Vettrine bar Lunch counters, Stainless steel warming surfaces, With infrared lamps, Showcases for bar Tables chauffées pour comptoir, Plateaux chauffés en inox, lampes à infrarouges, Vittrines pour bar Heiztische, Heizplatten aus rostfreiem stahl, Mit infrarotlampen, Bar-warmvittrinen	pag. 87
Carrelli portavassoi, Carrelli portateglie GN - Tray-holder trolley, GN pan trolley Chariot porte-plateaux, Chariots portes-plaques GN - Tablettwagen, GN Auflaufformenwagen	pag. 103
Carrelli portapiatti, vassoi e teglie - Dish, tray and pan carts Chariot porte-assiettes, plateaux et plaques - Geschirrwagen, Tablettwagen und Auflaufformenwagen	pag. 119
Carrelli portabiancheria, pulizia, multiuso - Laundry, cleaning, multipurpose trolley Chariots porte-linge, Nettoyage, Multi-usage - Wagen für Wäschereien, Reinigungsbetriebe, Mehrzweck	pag. 133
Carrelli portavalige e portabiti, Carrelli breakfast, Macchina pulisci-scarpe, Aste delimita corsie Luggage and Clothing stands, Breakfast trolley, Shoeshine machine, Lane poles Chariots porte-valises et porte-habits, Chariots Petit-déjeuner, Machine nettoyeuse de chaussures, Tige de délimitation de passage Koffertwagen und Kleiderständerwagen, Frühstückswagen, Apparat zum Schuhe putzen, Bahnabgrenzungstangen	pag. 145
Pattumiere e portarifiuti - Garbage and dust bin - Boîtes à ordures et poubelles - Abfallbehälter	pag. 161
Chafing dishes gastronorm, Distributori per caffè, caffè caldo, bevande, cereali, Zuppiera elettrica Chafing Dish, Distributors for coffee, hot coffee, beverages, cereals, Electric pan Bain-marie, Distributeurs de café, café chaud, boissons, cereals, Réceptacle électrique Chafing Dish, Distributoren für Kaffee, heißen Kaffee, Getränke, Getreide, Elektrische wanne	pag. 167
Bacinelle gastronorm e vaschette per gelato, Bacinelle gn in policarbonato, Accessori per cucina, Accessori per pizzeria, Bilancia elettronica GN basins and ice cream drums, GN pans in polycarbonate, Kitchen accessories, Accessories for pizzeria, Electronic scale Bacs Gastronorm et bacs à glace, Bacs GN en polycarbonate, Accessoires pour cuisines, Accessoires pour pizzeria, Balance électronique Gastronorm Schüssel und Eisschalen, GN Polycarbonatbehälter, Kochzubehöre, Zubehör für Pizzerien, Elektronische Waage	pag. 173
Ceppi, Copriceppo, Taglieri, Accessori per macelleria - Chopping Block, Chopping Block Cover, Chopping boards, Butchery accessories Souche, Couver Souche, Planches à hacher, Accessoires pour boucherie - Hackklotz, Hackklotzdecke, Hackbrette, Metzgereibetriebe	pag. 185
Sterilizzatori elettrici, Accessori antinfortunistici, Lavamani, Scaffalatura modulare, Elettroinsetticidi a lampade UV-A Electric sterilizers, Safety accessories, Wash basins, Modular shelving, Ultraviolet ray bug lamp Stérilisateur électriques, Accessoires de protection, Lave-mains, Rayonnement modulaire, Insecticide électrique à lampes UV-A Elektrische Sterilisatoren, Unfallschutz-Zubehör, Handwaschbecken, Bausteinregale, UV-A-Lampen-Insektenfänger	pag. 199

Carrelli di servizio in legno 
Carrelli gueridon
Carrelli di servizio in legno massello
Dolci, formaggi e antipasti
Carrello portavini
Carrelli flambè
Accessori per carrelli legno e acciaio
Mobili di servizio





Wodden service trolleys 
Gueridon trolleys
Solid wood serving trolley
Cake, cheese and hors d'oeuvres trolley
Wine trolley
Flambé trolley
Accessories for wooden and steel trolley
Serving furniture

Chariots de service en bois 
Chariots guéridons
Chariots de service en bois massif
Chariot pour dessert, fromages et hors d'oeuvres
Chariot à vins
Chariots pour plats flambés
Accessoires pour chariot en bois et en acier
Meubles de service

Servicewagen aus Holz 
Gueridon Wagen
Servicewagen aus massivem Holz
Kuchen, Käse und Vorspeisen Servierwagen
Weinwagen
Flambierwagen
Zubehör für Holz und Stahlwagen
Servicemöbel

Carrelli gueridon - Gueridon trolleys
Chariots guéridons - Gueridon Wagen



-  Struttura in acciaio inox tubolare alto spessore. 2 piani in nobilitato con bordo in gomma. 4 ruote multidirezionali Ø95.
-  Extra thick tubular steel structure with high quality wood veneer shelves. Four multidirectional wheels Ø95.
-  Structure en acier tubulaire de haute epaisseur avec deux rayons en simil-bois. Quatre roues pivotantes Ø95.
-  Gestell aus rostfreiem besonders starken Stahlrohr, 2 Platten aus veredeltem Holz. 4 leichtaufende Rollen, Ø95.





CA 900

€ 175,00

DIMENSIONI ESTERNE LxPxH cm
 EXTERNAL DIMENSIONS LxPxH cm
 DIMENSIONS EXTERIEURES LxPxH cm
 AUBENABMESSUNGEN LxPxH cm

65x50x78h



-  Struttura portante in tubo di acciaio inox. Ripiani in nobilitato noce con bordo in gomma. Ruote pivotanti.
-  Stainless steel tubular structure. Shelves covered with plastic laminated brown. Swivelling wheels.
-  Châssis porteur en tube d'acier inox. Etagères en bois revêtues de laminé plastique marron. Roues pivotantes.
-  Ragende Struktur aus Niro-Stahl-Rohr. Borde mit Nussverteilung, mit Gummirand Drehräder.

CA 901 2R

€ 235,00

CA 901 2RW





€ 235,00

DIMENSIONI ESTERNE LxPxH cm
 EXTERNAL DIMENSIONS LxPxH cm
 DIMENSIONS EXTERIEURES LxPxH cm
 AUBENABMESSUNGEN LxPxH cm

70x50x78h

Carrelli gueridon - Gueridon trolleys Chariots guéridons - Gueridon Wagen



-  Struttura portante in tubo di acciaio inox. Ripiani in nobilitato noce con bordo in gomma. Ruote pivotanti.
-  Stainless steel tubular structure. Shelves covered with plastic laminated brown. Swivelling wheels.
-  Châssis porteur en tube d'acier inox. Etagères en bois revêtues de laminé plastique marron. Roues pivotantes.
-  Tagende Struktur aus Niro-Stahl-Rohr. Borde mit Nussverteilung, mit Gummirand Drehräder.





CA 901 € 245,00

CA 901W € 245,00

DIMENSIONI ESTERNE LxPxH cm
EXTERNAL DIMENSIONS LxPxH cm
DIMENSIONS EXTERIEURES LxPxH cm
AUBENABMESSUNGEN LxPxH cm

70x50x78h



-  Montanti ottonati. Ripiani in nobilitato noce con bordo in gomma. Ruote pivotanti Ø95 ottonate.
-  Brass painted structure. Shelves covered with plastic laminated brown. Brass covered swivelling wheels Ø95.
-  Châssis porteur cuivée. Etagères en bois revêtues de laminé plastique marron. Roues pivotantes Ø95 cuivrées.
-  Vermessingte Struktur. Borde mit Nußverteilung, mit Gummirand Drehräder Ø95, vermessingt.

CO 902 € 290,00

DIMENSIONI ESTERNE LxPxH cm
EXTERNAL DIMENSIONS LxPxH cm
DIMENSIONS EXTERIEURES LxPxH cm
AUBENABMESSUNGEN LxPxH cm

70x50x78h

Carrelli gueridon - Gueridon trolleys Chariots guéridons - Gueridon Wagen



CL 903







CL 903W



CL 903B



CL 903N

-  Montanti in legno massello. Ripiani in nobilitato noce con bordo in gomma. Ruote piroettanti Ø95 ottonate.
-  Wood structure. Shelves covered with plastic laminated brown. Brass covered swivelling wheels Ø95.
-  Châssis porteur en bois. Étagères en bois revêtues de laminé plastique marron. Roues pivotantes Ø95 cuivrées.
-  Ständer aus Vollholz. Borde mit Nußverrgütung, mit Gummirand. Drehräder Ø95, vermessingt.

CL 903 € 220,00

CL 903W € 220,00

CL 903B € 450,00

CL 903N € 450,00

DIMENSIONI ESTERNE LxPxH cm





EXTERNAL DIMENSIONS LxPxH cm

DIMENSIONS EXTERIEURES LxPxH cm

AUßENABMESSUNGEN LxPxH cm

70x50x78h



-  Struttura in legno massello. Piani in multistrato di betulla tinto ciliegio. Ruote piroettanti Ø95 ottonate.
-  Solid wood frame. Multilayer surfaces of birchwood cherry colour. Pivoting brass wheels Ø95.
-  Structure en bois massif. Plateaux en feuilleté de bouleau couleur cerisier. Roues pivotantes Ø95 laitonées.
-  Aufbau aus massivem Holz. Platten aus Vielschichtigem Birkeholz Farbe Kirschbaum. Drehbare Räder Ø95, vermessingt.

LG 401 € 350,00

DIMENSIONI ESTERNE LxPxH cm





EXTERNAL DIMENSIONS LxPxH cm

DIMENSIONS EXTERIEURES LxPxH cm

AUßENABMESSUNGEN LxPxH cm

70x50x78h



-  Struttura in legno massello. Piani in multistrato di betulla. Ruote piroettanti Ø95.
-  Solid wood frame. Multilayer surfaces of birchwood. Pivoting wheels Ø95.
-  Structure en bois massif. Plateaux en feuilleté de bouleau. Roues pivotantes Ø95.
-  Aufbau aus massivem Holz. Platten aus Vielschichtigem Birkeholz. Drehbare Räder Ø95.

CLE € 408,00

DIMENSIONI ESTERNE LxPxH cm

EXTERNAL DIMENSIONS LxPxH cm

DIMENSIONS EXTERIEURES LxPxH cm

AUßENABMESSUNGEN LxPxH cm

90x45x77h

Optionals

Su richiesta verniciati con colori RAL

Available on request painted in RAL colours

Disponibles sur demande vernis dans les couleurs RAL

Auf Anfrage lieferbar lackiert in RAL Farben

€ 508,00

Carrelli flambè - Flambé trolley Chariots pour plats flambés - Flambierwagen

Struttura portante in legno multistrato di betulla tinto noce monocorpo con rivestimento in legno massello castagno. Piano di servizio ribaltante. 2 cassetti. Vano porta bombola da kg 2. Maniglia direzionale e portabottiglie ottonata. Piano di cottura in acciaio inox. Ruote multidirezionali.

Multilayer bichwood walnut colour monobloc side frames covered with solid chestnut-wood. Overturnable surface. 2 drawers. 2 kg gas cylinder space. Brass covered bottle-holder and handle. Stainless steel cooking-range. Multidirectional wheels.

Chassis monobloc en bois feuilleté de bouleau couleur noyer de châtaignier massif surface de service rabattante. 2 tiroirs. Coffre porte-bouteille de 2 kg. Poignée directionnelle et porte-bouteille cuivrée. Cusinière en acier inoxydable. Roues pivotantes.

Traggestell aus Vielschichtigem Birkeholz Nussbaum Farbe von einem Block mit massiver Kastanienholzverkleidung. Kippbare Servierplatte - 2 Schubladen. Raum für 2 kg. Gasflasche. Vermessingter Richtungsgriff und Flaschehalter, Kochfläche aus Edelstahl. Leichtlaufende Rollen.





CL 2750	€ 1.360,00	CL 2751	€ 1.205,00	CL 2752	€ 1.410,00
CL 2750W	€ 1.360,00	CL 2751W	€ 1.205,00	CL 2752W	€ 1.410,00
DIMENSIONI ESTERNE LxPxH cm EXTERNAL DIMENSIONS LxPxH cm DIMENSIONS EXTERIEURES LxPxH cm AUBENABMESSUNGEN LxPxH cm	107/145x 58x91 h	DIMENSIONI ESTERNE LxPxH cm EXTERNAL DIMENSIONS LxPxH cm DIMENSIONS EXTERIEURES LxPxH cm AUBENABMESSUNGEN LxPxH cm	107/145x 58x91 h	DIMENSIONI ESTERNE LxPxH cm EXTERNAL DIMENSIONS LxPxH cm DIMENSIONS EXTERIEURES LxPxH cm AUBENABMESSUNGEN LxPxH cm	107/145x 58x91 h
1 Piastra. 2 Fuochi 1 cooking range. 2 Fires 1 cusinière. 2 brûleurs 1 Kochfläche. 2 Kochstellen		1 Piastra a 1 Fuoco 1 cooking range. 1 Fire 1 cusinière. 1 brûleur 1 Kochfläche. 1 Kochstelle		2 Piastre a 1 Fuoco separate 2 cooking ranges with 1 fire each 2 cusinières avec 1 brûleur 2 Kochflächen mit 1 Kochstelle jeder	



Optionals

AB2	Bombola gas 2 Kg. (vuota) - 2 Kg gas cylinder (empty) Bouteille à gaz de 2 Kg (vide) - 2 Kg Gasflasche (leere)	€ 55,00
C	N. 4 ruote con cuffia ottonata - 4 wheels with brass painted covers 4 roues avec couverture cuivrée - 4 Räder mit Vermessingter Kappen	€ 130,00

Carrelli flambè - Flambé trolley

Chariots pour plats flambés - Flambierwagen

-  Mobile in legno nobilitato noce con piano di servizio ribaltabile, cassetto, maniglia portabottiglie in acciaio ottonato. Ruote ottonate Ø 100. Piano di cottura in acciaio inox con bruciatore regolabile.
-  Wooden unit veneered in walnut with swivelling top. Drawer, bottle-holder handle in brass-plated steel. Brass-plated wheels diam. 100. Cooking hob in stainless steel with adjustable burner.

-  Mouble contre-plaqué en noyer avec plan de service escamotable. Tiroir. Poignée du porte-bouteilles en acier laitonné. Roulettes laitonées Ø 100. Plan de cuisson en acier inox avec brûleur réglable.
-  Möbel aus Holz mit Nußvergütung, mit kippbarer Ablagefläche. Fach. Flaschenhalter-Griff aus vermessingtem Stahl. Vermessingte Rollen Ø 100. Kochfläche aus Niro-Stahl mit einstellbarem Brenner.



CF 1200	€ 905,00	CF 1201	€ 1.060,00	CF 1202	€ 1.120,00
CF 1200W WENGÉ	€ 905,00	CF 1201W WENGÉ	€ 1.060,00	CF 1202W WENGÉ	€ 1.120,00
DIMENSIONI ESTERNE LxPxH cm EXTERNAL DIMENSIONS LxPxH cm DIMENSIONS EXTERIEURES LxPxH cm AUBENABMESSUNGEN LxPxH cm	105/143x58x85 h	DIMENSIONI ESTERNE LxPxH cm EXTERNAL DIMENSIONS LxPxH cm DIMENSIONS EXTERIEURES LxPxH cm AUBENABMESSUNGEN LxPxH cm	105/143x58x85 h	DIMENSIONI ESTERNE LxPxH cm EXTERNAL DIMENSIONS LxPxH cm DIMENSIONS EXTERIEURES LxPxH cm AUBENABMESSUNGEN LxPxH cm	105/143x58x85 h
1 Piastra a 1 Fuoco 1 cooking range. 1 Fire 1 cusinière. 1 brûleur 1 Kochfläche. 1 Kochstelle		1 Piastra. 2 Fuochi 1 cooking range. 2 Fires 1 cusinière. 2. brûleurs 1 Kochfläche. 2 Kochstellen		2 piastre a 1 fuoco separate 2 cooking ranges with 1 fire each 2 Cusinières avec 1 brûleur 2 Kochfläche mit 1 Kochstelle jeder	

Optionals

AB3	Bombola gas 3 Kg. (vuota) - 3 Kg gas cylinder (empty) Bouteille à gaz de 3 Kg (vide) - 3 Kg Gasflasche (leere)	€ 60,00
------------	---	---------

Carrelli di servizio in legno - *Wodden service trolleys* Chariots de service en bois - *Servicewagen aus Holz*



CLP 2002



CLP 2002W



CLP 2002B



CLP 2002N

🇮🇹 Struttura in legno massello. Piani in multistrato di betulla tinto noce. Ruote piroettanti Ø 95 cromate.

🇬🇧 Solid wood frame. Multilayer surfaces of birchwood walnut colour. Pivoting chromium plated wheels Ø 95.

🇫🇷 Structure en bois massif. Plateaux en feuilleté de bouleau couleur noyer. Roues pivotantes Ø 95 chromées.

🇩🇪 Aufbau aus massivem Holz. Platten aus Vielschichtigem nussbaum Farbe Kirschbaum. Drehbare Räder Ø 95, verchromt.

CLP 2002 € 440,00

CLP 2002W € 440,00

CLP 2002B € 540,00

CLP 2002N € 540,00

DIMENSIONI ESTERNE LxPxH cm **110x55x82h**
EXTERNAL DIMENSIONS LxPxH cm **2 piani / 2 Shelves**
DIMENSIONS EXTERIEURES LxPxH cm **2 Rayons / 2 Platten**
AUBENABMESSUNGEN LxPxH cm



🇮🇹 Struttura in legno massello. Piani in multistrato di betulla tinto noce. Ruote piroettanti Ø 95 cromate.

🇬🇧 Solid wood frame. Multilayer surfaces of birchwood walnut colour. Pivoting chromium plated wheels Ø 95.

🇫🇷 Structure en bois massif. Plateaux en feuilleté de bouleau couleur noyer. Roues pivotantes Ø 95 chromées.

🇩🇪 Aufbau aus massivem Holz. Platten aus Vielschichtigem nussbaum Farbe Kirschbaum. Drehbare Räder Ø 95, verchromt.

CLP 2002 L40 € 380,00

CLP 2002 L40W € 380,00

DIMENSIONI ESTERNE LxPxH cm **110x40x82h**
EXTERNAL DIMENSIONS LxPxH cm **2 piani / 2 Shelves**
DIMENSIONS EXTERIEURES LxPxH cm **2 Rayons / 2 Platten**
AUBENABMESSUNGEN LxPxH cm

Carrelli di servizio in legno - Wodden service trolleys
Chariots de service en bois - Servicewagen aus Holz



CLP 2003



CLP 2003W



CLP 2003B



CLP 2003N

🇮🇹 Struttura in legno massello. Piani in multistrato di betulla tinto noce. Ruote piroettanti Ø 95 cromate.

🇬🇧 Solid wood frame. Multilayer surfaces of birchwood walnut colour. Pivoting chromium plated wheels Ø 95.

🇫🇷 Structure en bois massif. Plateaux en feuilleté de bouleau couleur noyer. Roues pivotantes Ø 95 chromées.

🇩🇪 Aufbau aus massivem Holz. Platten aus Vielschichtigem nussbaum Farbe Kirschbaum. Drehbare Räder Ø 95, verchromt.

CLP 2003 € 585,00

CLP 2003W € 585,00

CLP 2003B € 720,00

CLP 2003N € 720,00

DIMENSIONI ESTERNE LxPxH cm **110x55x89h**
 EXTERNAL DIMENSIONS LxPxH cm **3 piani / 3 Shelves**
 DIMENSIONS EXTERIEURES LxPxH cm **3 Rayons / 3 Platten**
 AUBENABMESSUNGEN LxPxH cm



🇮🇹 Struttura in legno massello. Piani in multistrato di betulla tinto noce. Ruote piroettanti Ø 95 cromate.

🇬🇧 Solid wood frame. Multilayer surfaces of birchwood walnut colour. Pivoting chromium plated wheels Ø 95.

🇫🇷 Structure en bois massif. Plateaux en feuilleté de bouleau couleur noyer. Roues pivotantes Ø 95 chromées.

🇩🇪 Aufbau aus massivem Holz. Platten aus Vielschichtigem nussbaum Farbe Kirschbaum. Drehbare Räder Ø 95, verchromt.

CLP 2003 L40 € 490,00





CLP 2003 L40W € 490,00

DIMENSIONI ESTERNE LxPxH cm **110x40x89h**
 EXTERNAL DIMENSIONS LxPxH cm **3 piani / 3 Shelves**
 DIMENSIONS EXTERIEURES LxPxH cm **3 Rayons / 3 Platten**
 AUBENABMESSUNGEN LxPxH cm

Carrelli di servizio in legno - *Wodden service trolleys* *Chariots de service en bois - Servicewagen aus Holz*



CLC 2012

-  Carrello per dolci, formaggi e antipasti in legno cupola in PLX semicircolare con coperchi rientranti.
-  Cake, cheese and hors d'oeuvres wooden trolley semicircular Plexiglas cover with re-entring lids.
-  Charoit en bois pour dessert fromages et hors d'oeuvres. Clochesemicerculaire en plexiglas avec couvercles rentrants.
-  Servierwagen aus holz fur Dessert, Kaese und vorspeisen. Halbrunde Kuppel aus Plexiglass mit Zuruecktretenden Deckeln.

CLC 2012 € 660,00

CLC 2012W € 660,00

CLC 2012B € 760,00

CLC 2012N € 760,00

DIMENSIONI ESTERNE LxPxH cm	110x55x107h
EXTERNAL DIMENSIONS LxPxH cm	2 piani / 2 Shelves
DIMENSIONS EXTERIEURES LxPxH cm	2 Rayons / 2 Platten
AUBENABMESSUNGEN LxPxH cm	



CLC 2012W



CLC 2012B







CLC 2012N

Carrelli di servizio in legno - Wodden service trolleys
Chariots de service en bois - Servicewagen aus Holz



CLC 2013

-  Carrello per dolci, formaggi e antipasti in legno cupola in PLX semicircolare con coperchi rientranti.
-  Cake, cheese and hors d'oeuvres wooden trolley semicircular Plexiglas cover with re-entring lids.
-  Chariot en bois pour dessert fromages et hors d'oeuvres. Clochesemicerculaire en plexigals avec couvercles rentrants.
-  Servierwagen aus Holz für Dessert, Käse und Vorspeisen. Halbrunde Kuppel aus Plexiglass mit Zurücktretenden Deckeln.

CLC 2013	€ 810,00
CLC 2013W	€ 810,00
CLC 2013B	€ 960,00
CLC 2013N	€ 960,00

DIMENSIONI ESTERNE LxPxH cm	110x55x114h
EXTERNAL DIMENSIONS LxPxH cm	3 piani / 3 Shelves
DIMENSIONS EXTERIEURES LxPxH cm	3 Rayons / 3 Platten
AUßENABMESSUNGEN LxPxH cm	



CLC 2013W



CLC 2013B



CLC 2013N

Optionals

A100	Pianetto reggiplatto a scomparsa - Rollaway dish holder surface Petit plateau porte assiette coulissant - Kleine verschwindbare Fellerhalterplatte	€ 50,00
A200	Cassetto portaposate a 3 scomparti - 3 buckets cutlery tray Panier à couverts à 3 compartiments - Besteckkasten mit 3 Fächer	€ 80,00





Carrelli di servizio in legno - *Wodden service trolleys* Chariots de service en bois - *Servicewagen aus Holz*



CL 70



CL 70W

-  Struttura in legno massello. Piani in multistrato di betulla tinto noce. Ruote piroettanti Ø 95 cromate.
-  Solid wood frame. Multilayer surfaces of birchwood walnut colour. Pivoting chromium plated wheels Ø 95.
-  Structure en bois massif. Plateaux en feuilleté de bouleau couleur noyer. Roues pivotantes Ø 95 chromées.
-  Aufbau aus massivem Holz. Platten aus Vielschichtem nussbaum Farbe Kirschbaum. Drehbare Räder Ø 95, verchromt.

CL 70 € 420,00

CL 70W € 420,00

DIMENSIONI ESTERNE LxPxH cm
EXTERNAL DIMENSIONS LxPxH cm
DIMENSIONS EXTERIEURES LxPxH cm
AUBENABMESSUNGEN LxPxH cm

70x50x85h

CL 90 € 455,00

CL 90W € 455,00

DIMENSIONI ESTERNE LxPxH cm
EXTERNAL DIMENSIONS LxPxH cm
DIMENSIONS EXTERIEURES LxPxH cm
AUBENABMESSUNGEN LxPxH cm

90x50x85h

 Accessori optional vedi pag. 30/31 -  Accessories on demand see page 30/31

 Accessoires sur demande voir page 30/31 -  Zubehöre auf Anfrage : sehen Sie Seite 30/31



A 1250 - A 1260 - A 1250W - A 1260W



A 1290 - A 1290W



A 1299 - A 1298 - A 1299W - A 1298W

Carrelli di servizio in legno - Wodden service trolleys Chariots de service en bois - Servicewagen aus Holz

-  Pianetto reggi piatto a scomparsa /
  Rollaway dish holder surface
 Petit plateau porte assiette coulissant /
  Kleine verschwindbare Fellerhalterplatte



A 100 optional

€ 50,00

Accessori optional per mod.
 Accessories on deman for mod.
 Accessoires sur demande pour mod.
 Zubehöre auf Anfrage für Mod.

CL 90 - CL 90W
CL 2001 - CL2001W
CL2151 - CL2151W







A 100W optional

€ 50,00

Accessori optional per mod.
 Accessories on deman for mod.
 Accessoires sur demande pour mod.
 Zubehöre auf Anfrage für Mod.

CL 70 - CL70W - CL2000 - CL2000W
CL2150 - CL2150W - CL 90 - CL 90W
CL 2001 - CL2001W - CL2151 - CL2151W

-  Cassetto portaposate a 2 scomparti /
  2 buckets cutlery tray
 Panier à couverts à 2 compartiments /
  Besteckkasten mit 2 Fächer



A 150 optional

€ 70,00

Accessori optional per mod.
 Accessories on deman for mod.
 Accessoires sur demande pour mod.
 Zubehöre auf Anfrage für Mod.

CL 70 - CL70W - CL2000 - CL2000W
CL2150 - CL2150W - CL 90 - CL 90W
CL 2001 - CL2001W - CL2151 - CL2151W







A 150W optional

€ 70,00

Accessori optional per mod.
 Accessories on deman for mod.
 Accessoires sur demande pour mod.
 Zubehöre auf Anfrage für Mod.

CL 70 - CL70W - CL2000 - CL2000W
CL2150 - CL2150W - CL 90 - CL 90W
CL 2001 - CL2001W - CL2151 - CL2151W

-  Cassetto portaposate a 3 scomparti /
  3 buckets cutlery tray
 Panier à couverts à 3 compartiments /
  Besteckkasten mit 3 Fächer



A 200 optional

€ 80,00

Accessori optional per mod.
 Accessories on deman for mod.
 Accessoires sur demande pour mod.
 Zubehöre auf Anfrage für Mod.

CL 90 - CL 90W
CL 2001 - CL2001W
CL2151 - CL2151W



A 200W optional

€ 80,00

Accessori optional per mod.
 Accessories on deman for mod.
 Accessoires sur demande pour mod.
 Zubehöre auf Anfrage für Mod.

CL 70 - CL70W - CL2000 - CL2000W
CL2150 - CL2150W - CL 90 - CL 90W
CL 2001 - CL2001W - CL2151 - CL2151W

Carrelli di servizio in legno - *Wodden service trolleys* Chariots de service en bois - *Servicewagen aus Holz*



CL 2000



CL 2000W

-  Carrello servizio legno. Struttura in legno multistrato di betulla tinto noce con spalliere portanti monoblocco. Piani in laminato antiacido con cornice perimetrale in legno massello. 4 ruote multidirezionali.
-  Multilayer birchwood walnut colour monobloc sides frames. Laminated acid-proof shelves with surrounding solid wood frame. 4 Multidirectional wheels.
-  Chariot service en bois massif. Structure en bois feuilleté de bouleau couleur noyer avec chassis portant monobloc, rayons en laminé antiacide avec corniche périmétrale en bois massif. 4 roues pivotantes.
-  Servicewagen aus Holz. Gestell aus Vielschichtem Birkeholz Nussbaum Farbe mit Tragseiten aus einem Block. Platten aus säurefestem Laminat mit Massivholzrahmen. 4 leichtlaufende Rollen.

CL 2000 € 550,00

CL 2000W € 550,00

DIMENSIONI ESTERNE LxPxH cm **86x55x85h**
EXTERNAL DIMENSIONS LxPxH cm *2 piani / 2 Shelves*
DIMENSIONS EXTERIEURES LxPxH cm *2 Rayons / 2 Platten*
AUBENABMESSUNGEN LxPxH cm

CL 2001 € 570,00

CL 2001W € 570,00

DIMENSIONI ESTERNE LxPxH cm **106x55x85h**
EXTERNAL DIMENSIONS LxPxH cm *2 piani / 2 Shelves*
DIMENSIONS EXTERIEURES LxPxH cm *2 Rayons / 2 Platten*
AUBENABMESSUNGEN LxPxH cm

 Accessori optional vedi pag. 30/31 -  Accessories on demand see page 30/31

 Accessoires sur demande voir page 30/31 -  Zubehör auf Anfrage : sehen Sie Seite 30/31



A 1270 - A 1280
A 1270W - A 1280W



A 1250 - A 1260
A 1250W - A 1260W



A 1290 - A 1290W



A 1299 - A 1298
A 1299W - A 1298W

Carrelli di servizio in legno - Wodden service trolleys
Chariots de service en bois - Servicewagen aus Holz



CL 2150



CL 2150W

- 🇮🇹 Carrello servizio legno. Struttura in legno multistrato di betulla tinto noce con spalliere portanti monocorpo. Piani in laminato antiacido con cornice perimetrale in legno massello. 4 ruote multidirezionali.
- 🇬🇧 Multilayer birchwood walnut colour monobloc sides frames. Laminated acid-proof shelves with surrounding solid wood frame. 4 Multidirectional wheels.
- 🇫🇷 Chariot service en bois massif. Structure en bois feuilleté de bouleau couleur noyer avec chassis portant monobloc, rayons en laminé antiacide avec corniche périmétrale en bois massif. 4 roues pivotantes.
- 🇩🇪 Servierwagen aus Holz. Gestell aus Vielschichtigem Birkeholz Nussbaum Farbe mit Tragseiten aus einen Block. Platten aus säurefestem Laminat mit Massivholzrahmen. 4 leichtlaufende Rollen.

CL 2150 € 640,00

CL 2150W € 640,00

DIMENSIONI ESTERNE LxPxH cm **86x55x85h**
 EXTERNAL DIMENSIONS LxPxH cm *3 piani / 3 Shelves*
 DIMENSIONS EXTERIEURES LxPxH cm *3 Rayons / 3 Platten*
 AUBENABMESSUNGEN LxPxH cm

CL 2151 € 670,00

CL 2151W € 670,00

DIMENSIONI ESTERNE LxPxH cm **106x55x85h**
 EXTERNAL DIMENSIONS LxPxH cm *3 piani / 3 Shelves*
 DIMENSIONS EXTERIEURES LxPxH cm *3 Rayons / 3 Platten*
 AUBENABMESSUNGEN LxPxH cm

🇮🇹 Accessori optional vedi pag. 30/31 - 🇬🇧 Accessories on demand see page 30/31

🇫🇷 Accessoires sur demande voir page 30/31 - 🇩🇪 Zubehöre auf Anfrage : sehen Sie Seite 30/31



A 1270 - A 1280
A 1270W - A 1280W



A 1250 - A 1260
A 1250W - A 1260W





A 1290 - A 1290W





A 1299 - A 1298
A 1299W - A 1298W

Carrelli di servizio in legno - *Wodden service trolleys* Chariots de service en bois - *Servicewagen aus Holz*

 Struttura, piani e contenitori in legno massello e controplaccato tinteleggiato ciliegio. Maniglia direzionale. Poggiapiatti scorrevole a scomparsa. Ruote pivotanti Ø mm 100.

 Framework in polished cherry-wood with carved uprights; cherry veneered shelves. Pushing handle. Sliding out dishholder. Full swivelling castors Ø mms 100.

 Châssis en cerisier, étagères et montants en bois cerisier. Poigné de direction. Porte-assiettes coulissant. Roulettes pivotantes Ø mm 100.

 Rohstruktur aus Kirschbaumholz. Abstellflächen und Behälter aus massivholz mit Kirschbaumholz furnierblatt. handgriff. Verschiebbare Tellerabstellplatte. Lenkräder Ø 100 mm.



LP 412

€ 650,00

DIMENSIONI ESTERNE LxPxH cm
EXTERNAL DIMENSIONS LxPxH cm
DIMENSIONS EXTERIEURES LxPxH cm
AUBENABMESSUNGEN LxPxH cm

81x56x81h

2 piani / 2 Shelves
2 Rayons / 2 Platten

LP 413

€ 680,00

DIMENSIONI ESTERNE LxPxH cm
EXTERNAL DIMENSIONS LxPxH cm
DIMENSIONS EXTERIEURES LxPxH cm
AUBENABMESSUNGEN LxPxH cm

113x56x81h

2 piani / 2 Shelves
2 Rayons / 2 Platten



LP 411

€ 780,00

DIMENSIONI ESTERNE LxPxH cm
EXTERNAL DIMENSIONS LxPxH cm
DIMENSIONS EXTERIEURES LxPxH cm
AUBENABMESSUNGEN LxPxH cm

81x56x81h

3 piani / 3 Shelves
3 Rayons / 3 Platten

LP 414

€ 830,00

DIMENSIONI ESTERNE LxPxH cm
EXTERNAL DIMENSIONS LxPxH cm
DIMENSIONS EXTERIEURES LxPxH cm
AUBENABMESSUNGEN LxPxH cm

113x56x81h

3 piani / 3 Shelves
3 Rayons / 3 Platten

Optionals

C

N. 4 ruote con cuffia - 4 wheels with covers - 4 roues avec couverture - 4 Räder mit Kappen

€ 130,00

ATTENZIONE! Le foto sono con OPTIONAL (ruote cuffiate) / **ATTENTION!** Photos shown on the catalogue are with OPTIONAL (wheels with hoods)
ATTENTION! Les photos sur le catalogue sont avec OPTIONAL (roues avec casques) / **ACHTUNG!** Die Photo auf dem Katalog sind EXTRAUSSTATTUNG (Rollen mit Kappen)

Carrelli di servizio in legno massello - Solid wood serving trolley Chariots de service en bois massif - Servicewagen aus massivem Holz

 Struttura in legno massello. Piani in multistrato di betulla tinto wengè. Ruote piroettanti Ø 100 cromate.

 Solid wood frame. Multilayer surfaces of birchwood walnut colour. Pivoting chromium plated wheels Ø 100.

 Structure en bois massif. Plateaux en feuilleté de bouleau couleur noyer. Roues pivotantes Ø 100 chromées.

 Aufbau aus massivem Holz. Platten aus Vielschichtem nussbaum Farbe Kirschbaum. Drehbare Räder Ø 100, verchromt.



LP 800W

€ 640,00

DIMENSIONI ESTERNE LxPxH cm
EXTERNAL DIMENSIONS LxPxH cm
DIMENSIONS EXTERIEURES LxPxH cm
AUBENABMESSUNGEN LxPxH cm

81x55x82h
2 piani / 2 Shelves
2 Rayons / 2 Platten

LP 1000W

€ 690,00

DIMENSIONI ESTERNE LxPxH cm
EXTERNAL DIMENSIONS LxPxH cm
DIMENSIONS EXTERIEURES LxPxH cm
AUBENABMESSUNGEN LxPxH cm

115x55x82h
2 piani / 2 Shelves
2 Rayons / 2 Platten



LP 850W

€ 770,00

DIMENSIONI ESTERNE LxPxH cm
EXTERNAL DIMENSIONS LxPxH cm
DIMENSIONS EXTERIEURES LxPxH cm
AUBENABMESSUNGEN LxPxH cm

81x55x82h
3 piani / 3 Shelves
3 Rayons / 3 Platten

LP 1050W

€ 825,00

DIMENSIONI ESTERNE LxPxH cm
EXTERNAL DIMENSIONS LxPxH cm
DIMENSIONS EXTERIEURES LxPxH cm
AUBENABMESSUNGEN LxPxH cm

115x55x82h
3 piani / 3 Shelves
3 Rayons / 3 Platten

ATTENZIONE! Le foto sono con OPTIONAL (ruote cuffiate) / **ATTENTION!** Photos shown on the catalogue are with OPTIONAL (wheels with hoods)
ATTENTION! Les photos sur le catalogue sont avec OPTIONAL (roues avec casques) / **ACHTUNG!** Die Photo auf dem Katalog sind EXTRAUSSTATTUNG (Rollen mit Kappen)

Carrelli di servizio in legno - Wooden service trolleys
Chariots de service en bois - Servicewagen aus Holz



LP 800

€ 640,00

DIMENSIONI ESTERNE LxPxH cm
 EXTERNAL DIMENSIONS LxPxH cm
 DIMENSIONS EXTERIEURES LxPxH cm
 AUBENABMESSUNGEN LxPxH cm

81x55x82h
 2 piani / 2 Shelves
 2 Rayons / 2 Platten

LP 1000

€ 690,00

DIMENSIONI ESTERNE LxPxH cm
 EXTERNAL DIMENSIONS LxPxH cm
 DIMENSIONS EXTERIEURES LxPxH cm
 AUBENABMESSUNGEN LxPxH cm

115x55x82h
 2 piani / 2 Shelves
 2 Rayons / 2 Platten



LP 850

€ 770,00

DIMENSIONI ESTERNE LxPxH cm
 EXTERNAL DIMENSIONS LxPxH cm
 DIMENSIONS EXTERIEURES LxPxH cm
 AUBENABMESSUNGEN LxPxH cm

81x55x82h
 3 piani / 3 Shelves
 3 Rayons / 3 Platten

LP 1050

€ 825,00

DIMENSIONI ESTERNE LxPxH cm
 EXTERNAL DIMENSIONS LxPxH cm
 DIMENSIONS EXTERIEURES LxPxH cm
 AUBENABMESSUNGEN LxPxH cm

115x55x82h
 3 piani / 3 Shelves
 3 Rayons / 3 Platten

ATTENZIONE! Le foto sono con OPTIONAL (ruote cuffiate) / **ATTENTION!** Photos shown on the catalogue are with OPTIONAL (wheels with hoods)
ATTENTION! Les photos sur le catalogue sont avec OPTIONAL (roues avec casques) / **ACHTUNG!** Die Photo auf dem Katalog sind EXTRAUSSTATTUNG (Rollen mit Kappen)

Dolci, formaggi e antipasti - Cake, cheese and hors d'oeuvres trolley

Chariot pour dessert, fromages et hors d'oeuvres - Kuchen, Käse und Vorspeisen Servierwagen

 Carrello servizio legno. Struttura in legno multistrato di betulla tinto noce con spalliere portanti monoblocco. Piani in laminato antiacido con cornice perimetrale in legno massello. 4 ruote multidirezionali.

 Multilayer birchwood walnut colour monobloc sides frames. Laminated acid-proof shelves with surrounding solid wood frame. 4 Multidirectional wheels.



 Chariot service en bois massif. Structure en bois feuilleté de bouleau couleur noyer avec châssis portant monobloc, rayons en laminé antiacide avec corniche périmétrale en bois massif. 4 roues pivotantes.

 Servierwagen aus Holz. Gestell aus Vielschichtem Birkeholz Nussbaum Farbe mit Tragseiten aus einem Block. Platten aus säurefestem Laminat mit Massivholzrahmen. 4 leichtlaufende Rollen.

CL 2590

€ 725,00

CL 2590W

€ 725,00

DIMENSIONI ESTERNE LxPxH cm
EXTERNAL DIMENSIONS LxPxH cm
DIMENSIONS EXTERIEURES LxPxH cm
AUBENABMESSUNGEN LxPxH cm

86x55x85h

*Due piani e cassetta portaposate a 6 scomparti
Two shelves, 6 compartment cutlery box
Deux étagères et casie portecouverts à 6 compartiments
Zwei Abstellflächen. Besteckkasten mit 6 Fächern*

CL 2591

€ 750,00

CL 2591W

€ 750,00

DIMENSIONI ESTERNE LxPxH cm
EXTERNAL DIMENSIONS LxPxH cm
DIMENSIONS EXTERIEURES LxPxH cm
AUBENABMESSUNGEN LxPxH cm

106x55x85h

*Due piani e cassetta portaposate a 8 scomparti
Two shelves, 8 compartment cutlery box
Deux étagères et casie portecouverts à 8 compartiments
Zwei Abstellflächen. Besteckkasten mit 8 Fächern*

Dolci, formaggi e antipasti - Cake, cheese and hors d'oeuvres trolley **Chariot pour dessert, fromages et hors d'oeuvres - Kuchen, Käse und Vorspeisen Servierwagen**

 Struttura, piani e contenitori in legno massello e controplaccato tinteggiato ciliegio. Maniglia direzionale. Poggiapiatti scorrevole a scomparsa. Ruote pivotanti Ø mm 100. Portata complessiva Kg 50.

 Framework in polished cherry-wood with carved uprights; cherry veneered shelves. Pushing handle. Sliding out dishholder. Full swivelling castors Ø mms 100. Total capacity 50 Kg.

 Châssis en cerisier, étagères et montants en bois contreplaqué cerisier. Poigné de direction. Porte-assiettes coulissant. Roulettes pivotantes Ø mm 100. Portée totale 50 Kg.

 Rohstruktur aus Kirschbaumholz. Abstellflächen und Behälter aus massivholz mit Kirschbaumholz furnierblatt. Handgriff. Verschiebbare Tellerabstellplatte. Lenkräder Ø 100 mm. Tragfähigkeit 50 Kg.



LPP 415

€ 830,00

DIMENSIONI ESTERNE LxPxH cm
EXTERNAL DIMENSIONS LxPxH cm
DIMENSIONS EXTERIEURES LxPxH cm
AUBENABMESSUNGEN LxPxH cm

81x56x81h

*Due piani e cassetta portaposate a 6 scomparti
Two shelves, 6 compartment cutlery box
Deux étagères et casie portecouverts à 6 compartiments
Zwei Abstellflächen. Besteckkasten mit 6 Fächern*

LPP 416

€ 880,00

DIMENSIONI ESTERNE LxPxH cm
EXTERNAL DIMENSIONS LxPxH cm
DIMENSIONS EXTERIEURES LxPxH cm
AUBENABMESSUNGEN LxPxH cm

113x56x81h

*Due piani e cassetta portaposate a 7 scomparti
Two shelves, 7 compartment cutlery box
Deux étagères et casie portecouverts à 7 compartiments
Zwei Abstellflächen. Besteckkasten mit 7 Fächern*

Optionals

C

N. 4 ruote con cuffia - 4 wheels with covers - 4 roues avec couverture - 4 Räder mit Kappen

€ 130,00

ATTENZIONE! Le foto sono con OPTIONAL (ruote cuffiate) / **ATTENTION!** Photos shown on the catalogue are with OPTIONAL (wheels with hoods)
ATTENTION! Les photos sur le catalogue sont avec OPTIONAL (roues avec casques) / **ACHTUNG!** Die Photo auf dem Katalog sind EXTRAUSSTATTUNG (Rollen mit Kappen)

Dolci, formaggi e antipasti - Cake, cheese and hors d'oeuvres trolley

Chariot pour dessert, fromages et hors d'oeuvres - Kuchen, Käse und Vorspeisen Servierwagen

 Struttura acciaio inox. Piano in nobilitato con cornice perimetrale in acciaio inox. Ruote multidirezionali. Paracolpi in gomma. Portata complessiva Kg 80.

 Extra thick squared tubular structure. Two high quality wood veneer shelves with surrounding steel frame. Four multidirectional wheels. Rubber buffer. Total capacity 80 Kg.

 Structure en acier tubulaire carré de haute épaisseur avec deux rayons en similbois et corniche périmétrale en acier. Quatre roues pivotantes. Butoir en gomme. Portée totale 80 Kg.

 Struktur aus viereckigen sehr starkem Rohrstaahl. Zwei Flächen aus verbessertem Holz mit umfassungsrahmen Ausstahl. Vier Multirichträder. Gummipuffer. Tragfähigkeit 80 Kg.



CA 1180

€ 460,00

CA 1180W

€ 460,00

DIMENSIONI ESTERNE LxPxH cm
EXTERNAL DIMENSIONS LxPxH cm
DIMENSIONS EXTERIEURES LxPxH cm
AUBENABMESSUNGEN LxPxH cm

85x57x97h

*Due piani e cassetta portaposate a 6 scomparti
Two shelves, 6 compartment cutlery box
Deux étagères et casie portecouverts à 6 compartiments
Zwei Abstellflächen. Besteckkastem mit 6 Fächern*



CA 1181

€ 490,00

CA 1181W

€ 490,00

DIMENSIONI ESTERNE LxPxH cm
EXTERNAL DIMENSIONS LxPxH cm
DIMENSIONS EXTERIEURES LxPxH cm
AUBENABMESSUNGEN LxPxH cm

105x57x97h

*Due piani e cassetta portaposate a 8 scomparti
Two shelves, 8 compartment cutlery box
Deux étagères et casie portecouverts à 8 compartiments
Zwei Abstellflächen. Besteckkastem mit 8 Fächern*

Dolci, formaggi e antipasti - Cake, cheese and hors d'oeuvres trolley **Chariot pour dessert, fromages et hors d'oeuvres - Kuchen, Käse und Vorspeisen Servierwagen**

 Carrello per dolci, formaggi e antipasti (REGGIPIATTO E CASSETTO PORTAPOSATE OPTIONAL). Il carrello in foto è con accessori A 100 portapiatti A 200 cassetto portaposate.

 Cake, cheese and hors d'oeuvres trolley (PLATE SUPPORT AND CUTLERY-HOLDER ARE OPTIONAL). The trolley pictured includes accessories A100 plate holder and A 200 cutlery tray.



 Chariot pour hors d'oeuvres, dessert et fromages (PORTE-COUVERTS ET PORTE-ASSIETTE SONT OPTIONAL). Le chariot illustré dans la photo est doté des accessoires A 100 porte-assiettes et A200 tiroir à couverts.

 Servierwagen für Desserts, Käse und Vorspeisen (TELLERHALTER UND BESTECKKASTEN SIND AUF ANFRAGE). Der Wagen auf dem Photo ist mit Zubehör A100, Tellerhalter, und A200, Besteckkasten.



CL 2350 € 750,00

CL 2350W € 750,00

DIMENSIONI ESTERNE LxPxH cm
EXTERNAL DIMENSIONS LxPxH cm
DIMENSIONS EXTERIEURES LxPxH cm
AUBENABMESSUNGEN LxPxH cm

86x55x95h

CL 2351 € 820,00

CL 2351W € 820,00

DIMENSIONI ESTERNE LxPxH cm
EXTERNAL DIMENSIONS LxPxH cm
DIMENSIONS EXTERIEURES LxPxH cm
AUBENABMESSUNGEN LxPxH cm

106x55x95h

 Coperchio in plx trasparente h mm150 montato su pistoni frenanti.

 Cakes and cheese trolleys. Dome type plx cover (h mm150) mounted on braking arms.

 Chariots à pâtisserie et à fromages. Cloche en plx (h mm 150) avec bras freinants.

 Chariots à pâtisserie et à fromages. Cloche en plx (h mm 150) avec bras freinants.

LDF 430 € 860,00

LDF 431 € 985,00

DIMENSIONI ESTERNE LxPxH cm
EXTERNAL DIMENSIONS LxPxH cm
DIMENSIONS EXTERIEURES LxPxH cm
AUBENABMESSUNGEN LxPxH cm

81x56x95h
2 piani / 2 Shelves
2 Rayons / 2 Platten

LDF 432 € 910,00

LDF 433 € 1.045,00

DIMENSIONI ESTERNE LxPxH cm
EXTERNAL DIMENSIONS LxPxH cm
DIMENSIONS EXTERIEURES LxPxH cm
AUBENABMESSUNGEN LxPxH cm

113x56x95h
3 piani / 3 Shelves
3 Rayons / 3 Platten

ATTENZIONE! Le foto sono con OPTIONAL (ruote cuffiate) / **ATTENTION!** Photos shown on the catalogue are with OPTIONAL (wheels with hoods)
ATTENTION! Les photos sur le catalogue sont avec OPTIONAL (roues avec casques) / **ACHTUNG!** Die Photo auf dem Katalog sind EXTRAUSSTATTUNG (Rollen mit Kappen)

Dolci, formaggi e antipasti - Cake, cheese and hors d'oeuvres trolley

Chariot pour dessert, fromages et hors d'oeuvres - Kuchen, Käse und Vorspeisen Servierwagen

 Cupola in plx semicircolare con coperchi rientranti. Il carrello in foto è con accessori A 100 porta piatti e A 200 cassetto portaposate (optional).

 Semicircular plexiglas dome with re-entering covers. The trolley pictured includes accessories A100 plate holder and A200 cutlery tray (optional).



 Cloche en plexiglas semi-circulaire à couvercles rentrants. Le chariot illustré sur la photo est doté des accessoires A100 porte-assiettes et A200 tiroir à couverts (optional).

 Halbrunde Kuppel aus Plexiglas mit zurücktretenden Deckeln. Der Wagen auf dem Photo ist mit Zubehör A100, Tellerhalter, und A200, Besteckkasten (extra ausstattung).



CL 2255

€ 740,00

CL 2255W

€ 740,00

DIMENSIONI ESTERNE LxPxH cm
EXTERNAL DIMENSIONS LxPxH cm
DIMENSIONS EXTERIEURES LxPxH cm
AUBENABMESSUNGEN LxPxH cm

86x55x110h

CL 2260

€ 770,00

CL 2260W

€ 770,00

DIMENSIONI ESTERNE LxPxH cm
EXTERNAL DIMENSIONS LxPxH cm
DIMENSIONS EXTERIEURES LxPxH cm
AUBENABMESSUNGEN LxPxH cm

106x55x110h

Optionals

A100 Pianetto reggipiatto a scomparsa - Rollaway dish holder surface
Petit plateau porte assiette coulissant - Kleine verschwindbare Fellerhalterplatte **€ 50,00**

A200 Cassetto portaposate a 3 scomparti - 3 buckets cutlery tray - Panier à couverts à 3 compartiments - Besteckkasten mit 3 Fächer **€ 80,00**

A210 Piano intermedio per CL2255 - CL2350 **€ 90,00**

A220 Piano intermedio per CCL2260 - CL2351 **€ 80,00**

C N. 4 ruote con cuffia - 4 wheels with covers - 4 roues avec couverture - 4 Räder mit Kappen **€ 130,00**

ATTENZIONE! Le foto sono con OPTIONAL (ruote cuffiate) / **ATTENTION!** Photos shown on the catalogue are with OPTIONAL (wheels with hoods)
ATTENTION! Les photos sur le catalogue sont avec OPTIONAL (roues avec casques) / **ACHTUNG!** Die Photo auf dem Katalog sind EXTRAUSSTATTUNG (Rollen mit Kappen)

Dolci, formaggi e antipasti - Cake, cheese and hors d'oeuvres trolley **Chariot pour dessert, fromages et hors d'oeuvres - Kuchen, Käse und Vorspeisen Servierwagen**

 Carrello servizio legno. Struttura in legno multistrato di betulla tinto wenge con spalliere portanti monoblocco. Piani in laminato antiacido con cornice perimetrale in legno massello. 4 ruote multidirezionali. Cupola plx.

 Wooden service trolley. Multilayer birchwood wenge colour monobloc sides frames. Laminated acid-proof shelves with surrounding solid wood frame. Multidirectional wheels. Plexiglass cover.

 Chariot service en bois. Structure en bois feuilleté de bouleau couleur wenge avec chassiss portant monobloc, rayons en laminé antiacide avec corniche périmétrale en bois massif et roues pivotantes. Couvercle en plexiglass.

 Servierwagen aus Holz. Vielschichtigem Birkeholzgestell wenge-Farbe mit Tragseiten aus einem Block. Platten aus säurefestem Laminat mit Massivholzrahmen, 4 leichtlaufende Rollen. Plexiglasdeckel.



LPC 800W

€ 820,00

DIMENSIONI ESTERNE LxPxH cm
EXTERNAL DIMENSIONS LxPxH cm
DIMENSIONS EXTERIEURES LxPxH cm
AUBENABMESSUNGEN LxPxH cm

81x55x108
2 piani / 2 Shelves
2 Rayons / 2 Platten

LPC1000W

€ 890,00

DIMENSIONI ESTERNE LxPxH cm
EXTERNAL DIMENSIONS LxPxH cm
DIMENSIONS EXTERIEURES LxPxH cm
AUBENABMESSUNGEN LxPxH cm

115x55x108
2 piani / 2 Shelves
2 Rayons / 2 Platten



LPC 850W

€ 935,00

DIMENSIONI ESTERNE LxPxH cm
EXTERNAL DIMENSIONS LxPxH cm
DIMENSIONS EXTERIEURES LxPxH cm
AUBENABMESSUNGEN LxPxH cm

81x55x108
3 piani / 3 Shelves
3 Rayons / 3 Platten

LPC 1050W

€ 1.030,00

DIMENSIONI ESTERNE LxPxH cm
EXTERNAL DIMENSIONS LxPxH cm
DIMENSIONS EXTERIEURES LxPxH cm
AUBENABMESSUNGEN LxPxH cm

115x55x108
3 piani / 3 Shelves
3 Rayons / 3 Platten

ATTENZIONE! Le foto sono con OPTIONAL (ruote cuffiate) / **ATTENTION!** Photos shown on the catalogue are with OPTIONAL (wheels with hoods)
ATTENTION! Les photos sur le catalogue sont avec OPTIONAL (roues avec casques) / **ACHTUNG!** Die Photo auf dem Katalog sind EXTRAUSSTATTUNG (Rollen mit Kappen)

Dolci, formaggi e antipasti - Cake, cheese and hors d'oeuvres trolley

Chariot pour dessert, fromages et hors d'oeuvres - Kuchen, Käse und Vorspeisen Servierwagen

 Carrello servizio legno. Struttura in legno multistrato di betulla tinto noce con spalliere portanti monocolpo. Piani in laminato antiacido con cornice perimetrale in legno massello. 4 ruote multidirezionali. Cupola plex.

 Wooden service trolley. Multilayer birchwood walnut colour monobloc sides frames. Laminated acid-proof shelves with surrounding solid wood frame. Multidirectional wheels. Plexiglass cover.

 Chariot service en bois. Structure en bois feuilleté de bouleau couleur noyer avec chassis portant monobloc, rayons en laminé antiacide avec corniche périmétrale en bois massif et roues pivotantes. Couverture en plexiglass.

 Servierwagen aus Holz. Vielschichtigem Birkeholzgestell Nussbaum Farbe mit Tragseiten aus einen Block. Platten aus säurefestem Laminat mit Massivholzrahmen, 4 leichtlaufende Rollen. Deckel aus plexiglas.



LPC 800

€ 820,00

DIMENSIONI ESTERNE LxPxH cm
EXTERNAL DIMENSIONS LxPxH cm
DIMENSIONS EXTERIEURES LxPxH cm
AUBENABMESSUNGEN LxPxH cm

81x55x108
2 piani / 2 Shelves
2 Rayons / 2 Platten



LPC1000

€ 890,00

DIMENSIONI ESTERNE LxPxH cm
EXTERNAL DIMENSIONS LxPxH cm
DIMENSIONS EXTERIEURES LxPxH cm
AUBENABMESSUNGEN LxPxH cm

115x55x108
2 piani / 2 Shelves
2 Rayons / 2 Platten

LPC 850

€ 935,00

DIMENSIONI ESTERNE LxPxH cm
EXTERNAL DIMENSIONS LxPxH cm
DIMENSIONS EXTERIEURES LxPxH cm
AUBENABMESSUNGEN LxPxH cm

81x55x108
3 piani / 3 Shelves
3 Rayons / 3 Platten

LPC 1050

€ 1.030,00

DIMENSIONI ESTERNE LxPxH cm
EXTERNAL DIMENSIONS LxPxH cm
DIMENSIONS EXTERIEURES LxPxH cm
AUBENABMESSUNGEN LxPxH cm

115x55x108
3 piani / 3 Shelves
3 Rayons / 3 Platten

ATTENZIONE! Le foto sono con OPTIONAL (ruote cuffiate) / **ATTENTION!** Photos shown on the catalogue are with OPTIONAL (wheels with hoods)
ATTENTION! Les photos sur le catalogue sont avec OPTIONAL (roues avec casques) / **ACHTUNG!** Die Photo auf dem Katalog sind EXTRAUSSTATTUNG (Rollen mit Kapfen)

Dolci, formaggi e antipasti - Cake, cheese and hors d'oeuvres trolley
Chariot pour dessert, fromages et hors d'oeuvres - Kuchen, Käse und Vorspeisen Servierwagen



LDF 436

€ 900,00

DIMENSIONI ESTERNE LxPxH cm
 EXTERNAL DIMENSIONS LxPxH cm
 DIMENSIONS EXTERIEURES LxPxH cm
 AUBENABMESSUNGEN LxPxH cm

113x56x105h
 2 piani / 2 Shelves
 2 Rayons / 2 Platten

LDF 437

€ 1.030,00

DIMENSIONI ESTERNE LxPxH cm
 EXTERNAL DIMENSIONS LxPxH cm
 DIMENSIONS EXTERIEURES LxPxH cm
 AUBENABMESSUNGEN LxPxH cm

113x56x105h
 3 piani / 3 Shelves
 3 Rayons / 3 Platten

🇮🇹 LDF 434/LDF 435 coperchio a due aperture con piano intermedio.

🇬🇧 LDF 434/435: in these models the showcase is provided with an auxiliary shelf and its cover can be raised from both sides.

🇫🇷 LDF 434/435: ces chariots ont le couvercle avec étagère mitoyenne et ouverture double.

🇩🇪 LDF 343/435: Deckel mit Abstellfläche in der Mitte und Zwei-seitiger Oeffnung.



LDF 434

€ 1.070,00

DIMENSIONI ESTERNE LxPxH cm
 EXTERNAL DIMENSIONS LxPxH cm
 DIMENSIONS EXTERIEURES LxPxH cm
 AUBENABMESSUNGEN LxPxH cm

113x56x120h
 2 piani / 2 Shelves
 2 Rayons / 2 Platten

LDF 435

€ 1.200,00



DIMENSIONI ESTERNE LxPxH cm
 EXTERNAL DIMENSIONS LxPxH cm
 DIMENSIONS EXTERIEURES LxPxH cm
 AUBENABMESSUNGEN LxPxH cm

113x56x120h
 3 piani / 3 Shelves
 3 Rayons / 3 Platten

ATTENZIONE! Le foto sono con OPTIONAL (ruote cuffiate) / **ATTENTION!** Photos shown on the catalogue are with OPTIONAL (wheels with hoods)
ATTENTION! Les photos sur le catalogue sont avec OPTIONAL (roues avec casques) / **ACHTUNG!** Die Photo auf dem Katalog sind EXTRAUSSTATTUNG (Rollen mit Kappen)

Dolci, formaggi e antipasti - Cake, cheese and hors d'oeuvres trolley

Chariot pour dessert, fromages et hors d'oeuvres - Kuchen, Käse und Vorspeisen Servierwagen

-  Coperchio a due aperture con piano intermedio.
-  In these models the showcase is provided with an auxiliary shelf and its cover can be raised from both sides.



-  Ces chariots ont le couvercle avec étagère mitoyenne et ouverture double.

-  Dechel mit Abstellfläche in der Mitte und Zweiseitiger Oeffnung.

LPC 1100

€ 1.060,00

DIMENSIONI ESTERNE LxPxH cm
EXTERNAL DIMENSIONS LxPxH cm
DIMENSIONS EXTERIEURES LxPxH cm
AUBENABMESSUNGEN LxPxH cm

81x56x120
2 piani / 2 Shelves
2 Rayons / 2 Platten

LPC1150

€ 1.180,00

DIMENSIONI ESTERNE LxPxH cm
EXTERNAL DIMENSIONS LxPxH cm
DIMENSIONS EXTERIEURES LxPxH cm
AUBENABMESSUNGEN LxPxH cm

116x56x120
3 piani / 3 Shelves
3 Rayons / 3 Platten



LPC 1100 W

€ 1.060,00

DIMENSIONI ESTERNE LxPxH cm
EXTERNAL DIMENSIONS LxPxH cm
DIMENSIONS EXTERIEURES LxPxH cm
AUBENABMESSUNGEN LxPxH cm

81x56x120
2 piani / 2 Shelves
2 Rayons / 2 Platten

LPC 1150 W

€ 1.180,00





DIMENSIONI ESTERNE LxPxH cm
EXTERNAL DIMENSIONS LxPxH cm
DIMENSIONS EXTERIEURES LxPxH cm
AUBENABMESSUNGEN LxPxH cm

116x56x120
3 piani / 3 Shelves
3 Rayons / 3 Platten

ATTENZIONE! Le foto sono con OPTIONAL (ruote cuffiate) / **ATTENTION!** Photos shown on the catalogue are with OPTIONAL (wheels with hoods)
ATTENTION! Les photos sur le catalogue sont avec OPTIONAL (roues avec casques) / **ACHTUNG!** Die Photo auf dem Katalog sind EXTRAUSSTATTUNG (Rollen mit Kappen)

Carrello portavini - Wine trolley Chariot à vins - Weinwagen



-  **Carrello Espositore vini. Doppio.** Struttura in legno.
-  **Double wine rack trolley.** Solid wood structure.
-  **Chariot pour exposition de vins. Double.** Espositore de vins. Structure en bois massif.
-  **Doppelweinauslage.** Gestell aus massivem Holz.

CL 2550 € 910,00

DIMENSIONI ESTERNE LxPxH cm
EXTERNAL DIMENSIONS LxPxH cm
DIMENSIONS EXTERIEURES LxPxH cm
AUBENABMESSUNGEN LxPxH cm





86x55x100h

CL 2551 € 980,00

DIMENSIONI ESTERNE LxPxH cm
EXTERNAL DIMENSIONS LxPxH cm
DIMENSIONS EXTERIEURES LxPxH cm
AUBENABMESSUNGEN LxPxH cm

106x55x100h



-  **Cantinetta** Espositore vini. Struttura in legno.
-  **Wine cellar** Wine rack. Solid wood structure.
-  **Petite cave** Espositore de vins. Structure en bois massif.
-  **Weinregal** Weinauslage. Gestell aus massivem Holz.

CL 2580 € 600,00

DIMENSIONI ESTERNE LxPxH cm
EXTERNAL DIMENSIONS LxPxH cm
DIMENSIONS EXTERIEURES LxPxH cm
AUBENABMESSUNGEN LxPxH cm

106x55x95h

ATTENZIONE! Le foto sono con OPTIONAL (ruote cuffiate)
ATTENTION! Photos shown on the catalogue are with OPTIONAL (wheels with hoods)
ATTENTION! Les photos sur le catalogue sont avec OPTIONAL (roues avec casques)
ACHTUNG! Die Photo auf dem Katalog sind EXTRAUSSTATTUNG (Rollen mit Kappen)

Accessori per carrelli legno e acciaio - Accessories for wooden and steel trolley Accessoires pour chariot en bois et en acier - Zubehör für Holz und Stahlwagen

 Espositore vini. Struttura in legno.

 Wine rack. Solid wood structure.



FOR MODELS:
CL2000W - CL2001W - CL2150W - CL2151W - CL2590W - CL2591W - CL90W

A 1250 € 190,00

DIMENSIONI ESTERNE LxPxH cm - EXTERNAL DIMENSIONS LxPxH cm
DIMENSIONS EXTERIEURES LxPxH cm - AUßENABMESSUNGEN LxPxH cm **68x46x19h**

A 1260 € 210,00

DIMENSIONI ESTERNE LxPxH cm - EXTERNAL DIMENSIONS LxPxH cm
DIMENSIONS EXTERIEURES LxPxH cm - AUßENABMESSUNGEN LxPxH cm **88x46x19h**

 Espositeur de vins. Structure en bois massif.

 Weinauslage. Gestell aus massivem Holz.



FOR MODELS:
CL2000W - CL2001W - CL2150W - CL2151W - CL2590W - CL2591W - CL90W

A 1250W € 190,00

DIMENSIONI ESTERNE LxPxH cm - EXTERNAL DIMENSIONS LxPxH cm
DIMENSIONS EXTERIEURES LxPxH cm - AUßENABMESSUNGEN LxPxH cm **68x46x19h**

A 1260W € 210,00

DIMENSIONI ESTERNE LxPxH cm - EXTERNAL DIMENSIONS LxPxH cm
DIMENSIONS EXTERIEURES LxPxH cm - AUßENABMESSUNGEN LxPxH cm **88x46x19h**

 Espositore liquori. Struttura in legno. Ringhiere in acciaio inox.

 Liqueur rack with solid wooden structure. Small stainless steel bottle-guards.



FOR MODELS: CL2000W - CL2001W - CL2150W - CL2151W - CL2590W - CL2591W

A 1270 € 200,00

DIMENSIONI ESTERNE LxPxH cm - EXTERNAL DIMENSIONS LxPxH cm
DIMENSIONS EXTERIEURES LxPxH cm - AUßENABMESSUNGEN LxPxH cm **68x46x37h**

A 1280 € 220,00

DIMENSIONI ESTERNE LxPxH cm - EXTERNAL DIMENSIONS LxPxH cm
DIMENSIONS EXTERIEURES LxPxH cm - AUßENABMESSUNGEN LxPxH cm **88x46x37h**

 Espositeur de liqueurs avec structure en bois massif. Gardebouteilles en acier inox.

 Spirituosenauslage Massivholzgestell mit Flaschenschutz aus Edelstahl.



FOR MODELS: CL2000W - CL2001W - CL2150W - CL2151W - CL2590W - CL2591W

A 1270W € 200,00

DIMENSIONI ESTERNE LxPxH cm - EXTERNAL DIMENSIONS LxPxH cm
DIMENSIONS EXTERIEURES LxPxH cm - AUßENABMESSUNGEN LxPxH cm **68x46x37h**

A 1280W € 220,00

DIMENSIONI ESTERNE LxPxH cm - EXTERNAL DIMENSIONS LxPxH cm
DIMENSIONS EXTERIEURES LxPxH cm - AUßENABMESSUNGEN LxPxH cm **88x46x37h**

Accessori per carrelli legno e acciaio - Accessories for wooden and steel trolley Accessoires pour chariot en bois et en acier - Zubehör für Holz und Stahlwagen

 Espositore ghiacciaia. Struttura in legno con vasca e griglia in acciaio inox. Cupola PLX. Provvisto di 8 contenitori eutettici.

 Ice-chest rack. Solid wooden frame. Stainless steel basin and grid. Plexiglass cover. Equipped with 8 eutetic each.



FOR MODELS:
CL2000W - CL2001W - CL2150W - CL2151W - CL2590W - CL2591W - CL70 - CL90

A 1290

€ 690,00

DIMENSIONI ESTERNE LxPxH cm
EXTERNAL DIMENSIONS LxPxH cm
DIMENSIONS EXTERIEURES LxPxH cm
AUBENABMESSUNGEN LxPxH cm

90x48,5x23h

 Espositeur glacière. Structure en bois massif. Cuve et grille en acier inoxydable. Cloche en plexiglass. Équipé avec 8 cartouches eutectiques.

 Eisauslage. Massivholzgestell. Schüssel und Gitter aus Edelstahl. Plexiglass-Deckel. Mit 8 Kühlplatten ausgestattet.



FOR MODELS:
CL2000W - CL2001W - CL2150W - CL2151W - CL2590W - CL2591W - CL70W - CL90W

A 1290W

€ 690,00

DIMENSIONI ESTERNE LxPxH cm
EXTERNAL DIMENSIONS LxPxH cm
DIMENSIONS EXTERIEURES LxPxH cm
AUBENABMESSUNGEN LxPxH cm

90x48,5x23h

 Vetrinetta. Struttura in legno. Cupola PLX.

 Wood veneer structure. Plexiglass cover.



FOR MODELS:
CL2000W - CL2001W - CL2150W - CL2151W - CL2590W - CL2591W - CL70W - CL90W

A 1299

€ 290,00

DIMENSIONI ESTERNE LxPxH cm - EXTERNAL DIMENSIONS LxPxH cm
DIMENSIONS EXTERIEURES LxPxH cm - AUBENABMESSUNGEN LxPxH cm

70x50x22h

A 1298

€ 300,00

DIMENSIONI ESTERNE LxPxH cm - EXTERNAL DIMENSIONS LxPxH cm
DIMENSIONS EXTERIEURES LxPxH cm - AUBENABMESSUNGEN LxPxH cm

90x50x22h

 Structure en simil bois. Cloche en plexiglass.

 Gestell aus veredeltem Holz. Plexiglass-Deckel.



FOR MODELS:
CL2000W - CL2001W - CL2150W - CL2151W - CL2590W - CL2591W - CL70W - CL90W

A 1299W

€ 290,00

DIMENSIONI ESTERNE LxPxH cm - EXTERNAL DIMENSIONS LxPxH cm
DIMENSIONS EXTERIEURES LxPxH cm - AUBENABMESSUNGEN LxPxH cm

70x50x22h

A 1298W

€ 300,00

DIMENSIONI ESTERNE LxPxH cm - EXTERNAL DIMENSIONS LxPxH cm
DIMENSIONS EXTERIEURES LxPxH cm - AUBENABMESSUNGEN LxPxH cm

90x50x22h

Mobili di servizio - Serving furniture
Meubles de service - Servicemöbel

- 🇮🇹 Struttura in legno di alto spessore, due cassetti portaposate a 3 scomparti. Piani a giorno. Ruote multidirezionali.
- 🇬🇧 Extra thick wooden structure, two 3-compartments cutlery holder. Open shelves. Multidirectional wheels.



- 🇫🇷 Structure en bois de haute épaisseur avec deux porte-couverts à 3 compartiments. Étagères ouvertes. Roues pivotantes.
- 🇩🇪 Rahmen aus besonders starkem, veredeltem Holz, zwei Besteckkasten mit 3 Fächern. Offene Platten. Leichtlaufende Rollen.



Mobile sala basso. 2 sportelli.
 Low service furniture. 2 doors.
 Meuble de service de salle bas. 2 portes.
 Niedriger Schrank mit 2 Türen.

ML 3000 SS € 590,00

ML 3000 SSW (Wenge) € 590,00

DIMENSIONI ESTERNE LxPxH cm
 EXTERNAL DIMENSIONS LxPxH cm
 DIMENSIONS EXTERIEURES LxPxH cm
 AUBENABMESSUNGEN LxPxH cm

95x49x99h

Sportello superiore in plx fumé.
 Upper door in plx gray colour.
 Volet supérieur en plx couleur gris.
 Obere Tür aus Sekuritglas.

ML 3170 SS € 870,00

ML 3170 ST € 960,00

DIMENSIONI ESTERNE LxPxH cm
 EXTERNAL DIMENSIONS LxPxH cm
 DIMENSIONS EXTERIEURES LxPxH cm
 AUBENABMESSUNGEN LxPxH cm

95x49x144h

Optionals

A250 Applicazione tramoggia per mobili - Bin for furniture - Tremie pour meubles - Behälter für möbel € 110,00

A250W (WENGÉ) Applicazione tramoggia per mobili - Bin for furniture - Tremie pour meubles - Behälter für möbel € 110,00



Mobile sala alto doppio, 1 sportello, 1 tramoggia.
 High double furniture 1 door, 1 bin.
 Double meuble de service de salle haut. 1 porte, 1 tremie.
 Hoher Doppelschrank 1 Tür, 1 Behälter.

ML 3150 ST € 870,00

ML 3150 STW WENGÉ € 870,00

DIMENSIONI ESTERNE LxPxH cm
 EXTERNAL DIMENSIONS LxPxH cm
 DIMENSIONS EXTERIEURES LxPxH cm
 AUBENABMESSUNGEN LxPxH cm

95x49x144h

Mobile sala alto doppio 2 sportelli.
 High double furniture 2 doors.
 Double meuble de service de salle haut 2 porte.
 Hoher Doppelschrank 2 Türen.

ML 3100 SS € 760,00

ML 3100 SSW WENGÉ € 760,00

DIMENSIONI ESTERNE LxPxH cm
 EXTERNAL DIMENSIONS LxPxH cm
 DIMENSIONS EXTERIEURES LxPxH cm
 AUBENABMESSUNGEN LxPxH cm

95x49x144h



Mobile sala alto singolo con sportello.
 High service furniture with door.
 Meuble de service de salle haut avec porte.
 Hoher Einzelschrank mit 1 Tür.

ML 3050 S € 650,00

DIMENSIONI ESTERNE LxPxH cm
 EXTERNAL DIMENSIONS LxPxH cm
 DIMENSIONS EXTERIEURES LxPxH cm
 AUBENABMESSUNGEN LxPxH cm

45x49x144h

Mobili di servizio - Serving furniture
Meubles de service - Servicemöbel

- 🇮🇹 Struttura impiallicciata di rovere sbiancato. Due cassetti portaporsate. Ruote multidirezionali. Struttura reggimensole a giorno in acciaio inox.
- 🇬🇧 Whitened oak veneered structure. Two cutlery holder drawers. Multidirectional wheels. Open stainless steel bracket holder.

- 🇫🇷 Structure plaquéé rouvre blanchi. Deux tiroirs à couverts roues pivotantes. Châssis porte-étagères ouvert en acier inox.
- 🇩🇪 Struktur von Gebleichtem Eichenholz Furniert. Zwei Besteckkasten Leichtlaufende Räder. Offener Plattenhaltergestell aus Edelstahl.



Mobile sala basso. 1 sportello.
 Low service furniture. 1 door.
 Meuble de service de salle bas. 1 portes.
 Niedriger Schrank mit 1 Türen.

ML 3200 S

€ 460,00

DIMENSIONI ESTERNE LxPxH cm
 EXTERNAL DIMENSIONS LxPxH cm
 DIMENSIONS EXTERIEURES LxPxH cm
 AUBENABMESSUNGEN LxPxH cm

45x48x95h



Mobile sala alto singolo con sportello.
 High service furniture with door.
 Meuble de service de salle haut avec porte.
 Hoher Einzelsschrank mit 1 Tür.

ML 3210 S

€ 660,00

DIMENSIONI ESTERNE LxPxH cm
 EXTERNAL DIMENSIONS LxPxH cm
 DIMENSIONS EXTERIEURES LxPxH cm
 AUBENABMESSUNGEN LxPxH cm

45x48x155h



Mobile sala basso. 2 sportelli.
 Low service furniture. 2 doors.
 Meuble de service de salle bas. 2 portes.
 Niedriger Schrank mit 2 Türen.

ML 3202 SS

€ 630,00

DIMENSIONI ESTERNE LxPxH cm
 EXTERNAL DIMENSIONS LxPxH cm
 DIMENSIONS EXTERIEURES LxPxH cm
 AUBENABMESSUNGEN LxPxH cm

90x48x95h



Mobile sala alto doppio 2 sportelli.
 High double furniture. 2 doors.
 Double meuble de service de salle haut 2 porte.
 Hoher Doppelschrank 2 Türen.

ML 3212 SS

€ 865,00

DIMENSIONI ESTERNE LxPxH cm
 EXTERNAL DIMENSIONS LxPxH cm
 DIMENSIONS EXTERIEURES LxPxH cm
 AUBENABMESSUNGEN LxPxH cm

90x48x155h

Optionals

A260

Applicazione tramoggia per mobili - Bin for furniture - Tremie pour meubles - Behälter für möbel

€ 110,00



Mobile sala basso. 2 sportelli. 3 cassetti.
Low service furniture. 2 doors. 3 drawers.
Meuble de service de salle bas. 2 portes. 3 tiroirs.
Niedriger Schrank mit 2 Türen. 3 Schubladen.

ML 3204 SS

€ 820,00

DIMENSIONI ESTERNE LxPxH cm
EXTERNAL DIMENSIONS LxPxH cm
DIMENSIONS EXTERIEURES LxPxH cm
AUBENABMESSUNGEN LxPxH cm

136x48x95h





Mobile sala alto doppio 2 sportelli. 3 cassetti.
High double furniture. 2 doors. 3 drawers.
Double meuble de service de salle haut 2 porte. 3 tiroirs.
Hoher Doppelschrank 2 Türen. 3 Schubladen.

ML 3214 SS

€ 1.100,00

DIMENSIONI ESTERNE LxPxH cm
EXTERNAL DIMENSIONS LxPxH cm
DIMENSIONS EXTERIEURES LxPxH cm
AUBENABMESSUNGEN LxPxH cm

136x48x155h

-  Struttura impiallicciata di wengé. Due cassetti portaposate. Ruote multidirezionali. Struttura reggimensole a giorno in acciaio inox.
-  Wengé oak veenered structure. Two cutlery holder drawers. Multidirectional wheels. Open stainless steel bracket holder.

 Structure plaquéé rouvre wengé. Deux tiroirs à couverts roues pivotantes. Châssis porte-étagères ouvert en acier inox.

 Struktur von Wenge Eichenholz Furniert. Zwei Besteckkasten Leichtlaufende Räder. Offender Plattenhaltergestell aus Edelstahl.



Mobile sala basso. 1 sportello.
 Low service furniture. 1 door.
 Meuble de service de salle bas. 1 portes.
 Niedriger Schrank mit 1 Türen.

ML 3200 SW

€ 460,00

ML 3200 SN

€ 460,00

DIMENSIONI ESTERNE LxPxH cm
 EXTERNAL DIMENSIONS LxPxH cm
 DIMENSIONS EXTERIEURES LxPxH cm
 AUßENABMESSUNGEN LxPxH cm

45x48x95h

Mobile sala alto singolo con sportelli.
 High service furniture with door.
 Meuble de service de salle haut avec porte.
 Hoher Einzelschrank mit 1 Tür.

ML 3210 SW

€ 660,00

ML 3210 SN

€ 660,00

DIMENSIONI ESTERNE LxPxH cm
 EXTERNAL DIMENSIONS LxPxH cm
 DIMENSIONS EXTERIEURES LxPxH cm
 AUßENABMESSUNGEN LxPxH cm

45x48x155h



Mobile sala basso. 2 sportelli.
 Low service furniture. 2 doors.
 Meuble de service de salle bas. 2 portes.
 Niedriger Schrank mit 2 Türen.

Mobile sala alto doppio 2 sportelli.
 High double furniture. 2 doors.
 Double meuble de service de salle haut 2 porte.
 Hoher Doppelschrank 2 Türen.

ML 3202 SSW € 630,00

ML 3212 SSW € 865,00

ML 3202 SSN € 630,00

ML 3212 SSN € 865,00

DIMENSIONI ESTERNE LxPxH cm
 EXTERNAL DIMENSIONS LxPxH cm
 DIMENSIONS EXTERIEURES LxPxH cm
 AUBENABMESSUNGEN LxPxH cm

90x48x95h

DIMENSIONI ESTERNE LxPxH cm
 EXTERNAL DIMENSIONS LxPxH cm
 DIMENSIONS EXTERIEURES LxPxH cm
 AUBENABMESSUNGEN LxPxH cm

90x48x155h

Optionals

A270 Applicazione tramoggia per mobili - Bin for furniture - Tremie pour meubles - Behälter für möbel € 110,00



Mobile sala basso. 2 sportelli. 3 cassetti.
 Low service furniture. 2 doors. 3 drawers.
 Meuble de service de salle bas. 2 portes. 3 tiroirs.
 Niedriger Schrank mit 2 Türen. 3 Schubladen.

ML 3204 SSW

€ 820,00

ML 3204 SSN

€ 820,00

DIMENSIONI ESTERNE LxPxH cm
 EXTERNAL DIMENSIONS LxPxH cm
 DIMENSIONS EXTERIEURES LxPxH cm
 AUßENABMESSUNGEN LxPxH cm

136x48x95h



Mobile sala alto doppio. 2 sportelli. 3 cassetti.
 High double furniture. 2 doors. 3 drawers.
 Double meuble de service de salle haut. 2 porte. 3 tiroirs.
 Hoher Doppelschrank. 2 Türen. 3 Schubladen.

ML 3214 SSW

€ 1.100,00

ML 3214 SSN

€ 1.100,00

DIMENSIONI ESTERNE LxPxH cm
 EXTERNAL DIMENSIONS LxPxH cm
 DIMENSIONS EXTERIEURES LxPxH cm
 AUßENABMESSUNGEN LxPxH cm

136x48x155h

Mobili di servizio - Serving furniture
Meubles de service - Servicemöbel

- 🇮🇹 Struttura impiallacciata colore noce e wengé. cassetti portaposate. Ruote multidirezionali. Struttura reggi pensili a giorno in acciaio plastificato.
- 🇬🇧 Veneered structure walnut and wengé colour. Cutlery drawers. Multi-directional wheels. Open wall units holder in plastic coated steel.

- 🇫🇷 Structure plaquée couleur noyer et wengé. Tiroirs à couverts. Roues pivotantes Structure soutenant les elements muraux ouverts en acier plastifié.
- 🇩🇪 Furnierte Struktur, Farbe Nussbraun und Wengé. Besteckkasten. Drehbare Räder Offene Wandschrankstruktur aus plastifiziertem Stahl.



Mobile sala alto doppio 2 sportelli. 3 cassetti. 3 pensili.
 High double furniture. 2 doors. 3 drawers. 3 wall units.
 Double meuble de service de salle haut. 2 porte. 3 tiroirs. 3 meubles muraux.
 Hoher Doppelschrank 2 Türen. 3 Schubladen. 3 Wandschränke.

ML 3214SSPN € 1.320,00

ML 3214SPW € 1.320,00

DIMENSIONI ESTERNE LxPxH cm
 EXTERNAL DIMENSIONS LxPxH cm
 DIMENSIONS EXTERIEURES LxPxH cm
 AUBENABMESSUNGEN LxPxH cm
137x48x153h

Mobile sala alto doppio 2 sportelli. 2 cassetti. 2 pensili.
 High double furniture. 2 doors. 2 drawers. 2 wall units.
 Double meuble de service de salle haut 2 porte. 2 tiroirs. 2 meubles muraux.
 Hoher Doppelschrank 2 Türen. 2 Schubladen. 2 Wandschränke.

ML 3212SSPN € 1.060,00

ML 3212SPW € 1.060,00

DIMENSIONI ESTERNE LxPxH cm
 EXTERNAL DIMENSIONS LxPxH cm
 DIMENSIONS EXTERIEURES LxPxH cm
 AUBENABMESSUNGEN LxPxH cm
92x48x153h



Carrelli di servizio inox 
Carrelli di servizio inox trasporto pesante
Dolci, formaggi e antipasti
Carrello multiuso in plastica con montanti
in alluminio anodizzato



Stainless steel service trolleys 
Stainless steel service trolleys heavy transport
Cake, cheese and hors d'oeuvres trolley
Plastic multi-service trolley with upright
in anodised aluminium

Chariots de service inox 
Chariots de service inox transport lourd
Chariot pour dessert, fromages et hors d'oeuvres
Chariot multiservice en plastique avec montants
en aluminium anodisé

Servicewagen aus Edelstahl 
Servicewagen aus Edelstahl Schwer transport
Kuchen, Käse und Vorspeisen Servierwagen
Allzweckplastikwagen mit Pfosten
aus eloxiert Aluminium

Carrello multiuso in plastica - Plastic multi-service trolley
Chariot multiservice en plastique - Allzweckplastikwagen

-  Carrello multiuso in plastica con montanti in alluminio anodizzato.
-  Plastic multi-service trolley with upright in anodised aluminium.

-  Chariot multiservice en plastique avec montants en aluminium anodisé.
-  Allzweckplastikwagen mit Pfosten aus eloxiert Aluminium.



CP 1008

€ 90,00

DIMENSIONI ESTERNE LxPxH cm
 EXTERNAL DIMENSIONS LxPxH cm
 DIMENSIONS EXTERIEURES LxPxH cm
 AUBENABMESSUNGEN LxPxH cm

85x43x95h



CP 1010

€ 135,00

DIMENSIONI ESTERNE LxPxH cm
 EXTERNAL DIMENSIONS LxPxH cm
 DIMENSIONS EXTERIEURES LxPxH cm
 AUBENABMESSUNGEN LxPxH cm

102x50x96h



A 1001





A 1002

Optionals

- | | | |
|--------------|---|----------------|
| A1001 | Cestino piccolo - Small basket
Petit panier - Klein Korb (per/for CP 1010) | € 10,00 |
| A1002 | Cestino grande - Big basket
Grand panier - Gros Korb (per/for CP 1010) | € 22,00 |

Carrelli di servizio inox - Stainless steel service trolleys Chariots de service inox - Servicewagen aus Edelstahl

 Struttura acciaio inox - Piano in nobilitato con cornice perimetrale in acciaio inox. Ruote multidirezionali. Paracolpi in gomma.

 Extra thick squared tubular structure. High quality wood veneer shelves with surrounding steel frame. Multidirectional wheels, rubber buffer.



WENGE - CA 1000W

 Structure en acier tubulaire carré de haute épaisseur. Rayons en similbois et corniche périmétrale en acier. Quatre roues pivotantes. Butoir en gomme.

 Struktur aus viereckigen sehr starkem Röhrohrstahl. Flächen aus verbessertem Holz mit umfassungsrahmen Ausstahl. Multirichträder. Gummipuffer.

CA 1000 € 250,00

CA 1000W € 250,00

DIMENSIONI ESTERNE LxPxH cm
EXTERNAL DIMENSIONS LxPxH cm
DIMENSIONS EXTERIEURES LxPxH cm
AUBENABMESSUNGEN LxPxH cm

83x57x97h

CA 1001 € 260,00

CA 1001W € 260,00

DIMENSIONI ESTERNE LxPxH cm
EXTERNAL DIMENSIONS LxPxH cm
DIMENSIONS EXTERIEURES LxPxH cm
AUBENABMESSUNGEN LxPxH cm

103x57x97h

*Due piani
Two shelves
Deux rayons
Zwei platten*



NOCE - CA 1050

CA 1050 € 330,00

CA 1050W € 330,00

DIMENSIONI ESTERNE LxPxH cm
EXTERNAL DIMENSIONS LxPxH cm
DIMENSIONS EXTERIEURES LxPxH cm
AUBENABMESSUNGEN LxPxH cm

83x57x97h

CA 1051 € 350,00

CA 1051W € 350,00

DIMENSIONI ESTERNE LxPxH cm
EXTERNAL DIMENSIONS LxPxH cm
DIMENSIONS EXTERIEURES LxPxH cm
AUBENABMESSUNGEN LxPxH cm

103x57x97h

*3 piani
3 shelves
3 rayons
3 Platten*

Carrelli di servizio inox - Stainless steel service trolleys
Chariots de service inox - Servicewagen aus Edelstahl



Multiservizi - 4 Piani
 Multiservice - 4 Shelves
 Charlot multiservice - 4 Rayons
 Mehrzweckwagen - 4 Platten

CA 1070

€ 430,00

DIMENSIONI ESTERNE LxPxH cm
 EXTERNAL DIMENSIONS LxPxH cm
 DIMENSIONS EXTERIEURES LxPxH cm
 AUBENABMESSUNGEN LxPxH cm

83x57x172h

CA 1071

€ 455,00

DIMENSIONI ESTERNE LxPxH cm
 EXTERNAL DIMENSIONS LxPxH cm
 DIMENSIONS EXTERIEURES LxPxH cm
 AUBENABMESSUNGEN LxPxH cm

103x57x172h



🇮🇹 Struttura in acciaio inox. Piani in acciaio inox piegati, satinati, insonorizzati. Ruote multidirezionali. Paracolpi in gomma. Portata complessiva 80 Kg.

🇬🇧 Stainless steel structur. Stainless steel folded, anti-noise and sated shelves. Multidirectional wheels. Rubber buffer. Total capacity 80 Kg.

🇫🇷 Structure en acier inoxydable. Rayons en acier inoxydable, pliés, antibruits et satinés. Roues pivotantes. Butoir en gomme. Portée totale 80 Kg.

🇩🇪 Gestell aus rostfreiem Stahl. Gebogene, Schallgedämmte mit satinierter Oberfläche Platten aus rostfreiem Stahl. Leichtlaufende Rollen Gummipuffer. Tragfähigkeit 80 Kg.

CA 1382

€ 250,00

DIMENSIONI ESTERNE LxPxH cm - EXTERNAL DIMENSIONS LxPxH cm
 DIMENSIONS EXTERIEURES LxPxH cm - AUBENABMESSUNGEN LxPxH cm

83x57x97h

CA 1383

€ 270,00

DIMENSIONI ESTERNE LxPxH cm - EXTERNAL DIMENSIONS LxPxH cm
 DIMENSIONS EXTERIEURES LxPxH cm - AUBENABMESSUNGEN LxPxH cm

103x57x97h

2 Piani - 2 Shelves - 2 Rayons - 2 Platten



Optionals

A1001

Cestino piccolo - Small basket
 Petit panier - Klein Korb

€ 10,00

A1002

Cestino grande - Big basket
 Grand panier - Gros Korb

€ 22,00

Carrelli di servizio inox - Stainless steel service trolleys

Chariots de service inox - Servicewagen aus Edelstahl



 Struttura in acciaio inox. Piani in acciaio inox piegati, satinati, insonorizzati. Ruote multidirezionali. Paracolpi in gomma. Portata complessiva 80 Kg.

 Stainless steel structur. Stainless steel folded, anti-noise and satinised shelves. Multidirectional wheels. Rubber buffer. Total capacity 80 Kg.

 Structure en acier inoxydable. Rayons en acier inoxydable, pliés, antibruités et satinés. Roues pivotantes. Butoir en gomme. Portée totale 80 Kg.

 Gestell aus rostfreiem Stahl. Gebogene, Schallgedämmte mit satinierter Oberfläche Platten aus rostfreiem Stahl. Leichtlaufende Rollen Gummipuffer. Tragfähigkeit 80 Kg.

CA 1384 € 330,00

DIMENSIONI ESTERNE LxPxH cm - EXTERNAL DIMENSIONS LxPxH cm
DIMENSIONS EXTERIEURES LxPxH cm - AUßENABMESSUNGEN LxPxH cm **83x57x97h**

CA 1385 € 360,00

DIMENSIONI ESTERNE LxPxH cm - EXTERNAL DIMENSIONS LxPxH cm
DIMENSIONS EXTERIEURES LxPxH cm - AUßENABMESSUNGEN LxPxH cm **103x57x97h**

3 Piani - 3 Shelves - 3 Rayons - 3 Platten

Optionals

A1001 Cestino piccolo - Small basket
Petit panier - Klein Korb € 10,00

A1002 Cestino grande - Big basket
Grand panier - Gros Korb € 22,00

Multiservizi - 4 Piani
Multiservice - 4 Shelves
Charlot multiservice - 4 Rayons
Mehrzweckwagen - 4 Platten

CA 1380 € 435,00

DIMENSIONI ESTERNE LxPxH cm
EXTERNAL DIMENSIONS LxPxH cm
DIMENSIONS EXTERIEURES LxPxH cm
AUßENABMESSUNGEN LxPxH cm **83x57x172h**

CA 1381 € 475,00

DIMENSIONI ESTERNE LxPxH cm
EXTERNAL DIMENSIONS LxPxH cm
DIMENSIONS EXTERIEURES LxPxH cm
AUßENABMESSUNGEN LxPxH cm **103x57x172h**

Optionals

A1001 Cestino piccolo con supporto - Little basket stand
Petit panier avec support - Kleiner korb mit halterung (per/for CA 1382/83/84/85) € 10,00

A1002 Cestino grande - Big basket
Grand panier - Gros Korb (per/for CA 1382/83/84/85) € 22,00

Carrelli di servizio inox - Stainless steel service trolleys

Chariots de service inox - Servicewagen aus Edelstahl

 Struttura tubolare acciaio inox tonda Ø 25, alto spessore con piani stampati in forma di vassoio con bordi arrotondati - insonorizzati con finitura satinata - Ruote multidirezionali. Paracolpi in gomma. Portata complessiva Kg 100.

 Extra thick tubular stainless steel structure Ø 25. Tray - shape moulded shelves. Rounded edges. Anti-noise satined finish. Multidirectional wheels. Rubber buffer. Total capacity 100 Kg.



 Structure en acier inox tubulaire de haute épaisseur Ø 25. Rayons estampés a forme de plateau. Bord arrondi. Finissage satiné anti-bruit. Roues pivotantes. Butoir en gomme. Portée totale 100 Kg.

 Gestell aus sehr starkem, viereckigem Stahlrohr Ø 25, bedruckte, tablettförmige Platten mit abgerundeten Kanten, schallgedämmt, mit satinierte Oberfläche. Leichtlaufende Rollen Gummipuffer. Tragfähigkeit 100 Kg.

2 piani
2 Shelves
2 Rayons
2 Platten

CA 1390

€ 250,00

DIMENSIONI ESTERNE LxPxH cm
EXTERNAL DIMENSIONS LxPxH cm
DIMENSIONS EXTERIEURES LxPxH cm
AUBENABMESSUNGEN LxPxH cm

87x59x93h

CA 1391

€ 260,00

DIMENSIONI ESTERNE LxPxH cm
EXTERNAL DIMENSIONS LxPxH cm
DIMENSIONS EXTERIEURES LxPxH cm
AUBENABMESSUNGEN LxPxH cm

109x59x93h



3 piani
3 Shelves
3 Rayons
3 Platten

CA 1410

€ 320,00

DIMENSIONI ESTERNE LxPxH cm
EXTERNAL DIMENSIONS LxPxH cm
DIMENSIONS EXTERIEURES LxPxH cm
AUBENABMESSUNGEN LxPxH cm

87x59x103h

CA 1411

€ 340,00

DIMENSIONI ESTERNE LxPxH cm
EXTERNAL DIMENSIONS LxPxH cm
DIMENSIONS EXTERIEURES LxPxH cm
AUBENABMESSUNGEN LxPxH cm

109x59x103h

Carrelli di servizio inox - Stainless steel service trolleys
Chariots de service inox - Servicewagen aus Edelstahl



4 piani
 4 Shelves
 4 Rayons
 4 Platten

CA 1424 € 420,00

DIMENSIONI ESTERNE LxPxH cm
 EXTERNAL DIMENSIONS LxPxH cm
 DIMENSIONS EXTERIEURES LxPxH cm
 AUBENABMESSUNGEN LxPxH cm

87x59x140h

CA 1425 € 450,00

DIMENSIONI ESTERNE LxPxH cm
 EXTERNAL DIMENSIONS LxPxH cm
 DIMENSIONS EXTERIEURES LxPxH cm
 AUBENABMESSUNGEN LxPxH cm

109x59x140h



5 piani
 5 Shelves
 5 Rayons
 5 Platten

CA 1426 € 500,00

DIMENSIONI ESTERNE LxPxH cm
 EXTERNAL DIMENSIONS LxPxH cm
 DIMENSIONS EXTERIEURES LxPxH cm
 AUBENABMESSUNGEN LxPxH cm

87x59x170h

CA 1427 € 540,00

DIMENSIONI ESTERNE LxPxH cm
 EXTERNAL DIMENSIONS LxPxH cm
 DIMENSIONS EXTERIEURES LxPxH cm
 AUBENABMESSUNGEN LxPxH cm



109x59x170h



Optionals

A512 Ruote con freno - Wheels with catch - Roues avec frein - Räder mit Bremse € 7,00 cad./each

Carrelli di servizio inox - Stainless steel service trolleys

Chariots de service inox - Servicewagen aus Edelstahl

-  Carrello struttura acciaio inox con fori e sacchi porta rifiuti ruote multidirezionali paracolpi in gomma (sacchi esclusi).
-  Trolley with stainless steel structure, with holes and waste sacks. Multi-directional wheels. Rubber buffers (Sacks not included).

-  Chariot avec chassis en acier inox avec trous et sacs de litières. Roues pivotantes. Butoirs en caoutchouc (Sacs pas compris).
-  Wagen mit Struktur aus Edelstahl mit Lochern und Abfallsäcken. Drehbare Räder. Gummipuffer (Säcke nicht inbegriffen).



CA 1390S

€ 300,00

DIMENSIONI ESTERNE LxPxH cm
EXTERNAL DIMENSIONS LxPxH cm
DIMENSIONS EXTERIEURES LxPxH cm
AUBENABMESSUNGEN LxPxH cm

89x59x93h

CA 1391S

€ 320,00

DIMENSIONI ESTERNE LxPxH cm
EXTERNAL DIMENSIONS LxPxH cm
DIMENSIONS EXTERIEURES LxPxH cm
AUBENABMESSUNGEN LxPxH cm

109x59x93h



CA 1391S2

€ 370,00

DIMENSIONI ESTERNE LxPxH cm
EXTERNAL DIMENSIONS LxPxH cm
DIMENSIONS EXTERIEURES LxPxH cm
AUBENABMESSUNGEN LxPxH cm

109x59x93h

Carrelli di servizio inox - Stainless steel service trolleys Chariots de service inox - Servicewagen aus Edelstahl

 **CARRELLO ACCIAIO INOX DA SBARAZZO.** Vasca superiore inox h 150 insonorizzata. Piano inferiore inox piegato. Ruote multidirezionali. Paracolpi in gomma. Portata complessiva Kg 80.

 **STAINLESS STEEL CLEARING TROLLEY.** Stainless steel upper basin h 150 anti-noise. Stainless steel shelf below, folded. Multidirectional wheels. Rubber buffer. Total capacity 80 Kg.



 **CHARIOT DE RANGEMENT.** Cuve supérieure en acier inoxydable h 150 antibruits. Rayon inférieur en acier inoxydable, plié. Roues pivotantes. Butoir en gomme. Portée totale 80 Kg.

 **EN ACIER INOX - ABLAGEWAGEN AUS INOX-STAHL.** Schallgedämmtes oberes Becken aus Edelstahl h 150, gebogene untere Platte aus Edelstahl. Leichtlaufende Rollen, Gummipuffer. Tragfähigkeit 80 Kg.

2 vasche 150 h.
2 - 150 h basins
2 cuves 150 h
2 Becken 150 h

CA 1389

€ 435,00

DIMENSIONI ESTERNE LxPxH cm
EXTERNAL DIMENSIONS LxPxH cm
DIMENSIONS EXTERIEURES LxPxH cm
AUBENABMESSUNGEN LxPxH cm

101x57x97h



1 vasca 150 h.
1 - 150 h sasin
1 cuve 150 h
1 Becken 150 h.

CA 1388

€ 380,00

DIMENSIONI ESTERNE LxPxH cm
EXTERNAL DIMENSIONS LxPxH cm
DIMENSIONS EXTERIEURES LxPxH cm
AUBENABMESSUNGEN LxPxH cm

101x57x97h

Carrelli di servizio inox - Stainless steel service trolleys
Chariots de service inox - Servicewagen aus Edelstahl



2 vasche 65 h.
 2 - 65 h basin
 2 cuve 65 h
 2 Becken 65 h.

CA 1396

€ 310,00

DIMENSIONI ESTERNE LxPxH cm
 EXTERNAL DIMENSIONS LxPxH cm
 DIMENSIONS EXTERIEURES LxPxH cm
 AUBENABMESSUNGEN LxPxH cm

91x57x97h



 CARRELLO PORTABACINELLE GN. Struttura in acciaio inox. Piano inferiore in acciaio inox piegato, insonorizzato. Ruote multidirezionali. Paracolpi in gomma. Bacinelle escluse.

 GN BASIN TROLLEY. Stainless steel structure. Stainless steel shelf below, folded and antinoise. Multidirectional wheels. Rubber buffer. Containers not included.

 CHARIOT PORTE-BAC GN. Chariot porte-cuvettes GN. Structure en acier inoxydable. Rayon inférieur en acier inoxydable, plié et anti-bruits. Roues pivotantes. Butoir en gomme. Cuvettes exclues.

 SCHÜSSEL-WAGEN GN. GN behälterwagen. Gestell aus rostfreiem Stahl. gebogene, Schallgeduammte untere Platte aus rostfreiem Stahl. Leichtlaufende Rollen. Gummipuffer. Behälter nicht einbezogen.

CA 1386

€ 220,00

DIMENSIONI ESTERNE LxPxH cm
 EXTERNAL DIMENSIONS LxPxH cm
 DIMENSIONS EXTERIEURES LxPxH cm
 AUBENABMESSUNGEN LxPxH cm

N° 2 GN 1/1
77x62x97h

CA 1387

€ 240,00

DIMENSIONI ESTERNE LxPxH cm
 EXTERNAL DIMENSIONS LxPxH cm
 DIMENSIONS EXTERIEURES LxPxH cm
 AUBENABMESSUNGEN LxPxH cm

N° 3 GN 1/1
110x62x97h

Optionals

A512 Ruote con freno - Wheels with catch - Roues avec frein - Räder mit Bremse

€ 7,00 cad./each

Carrelli di servizio inox - Stainless steel service trolleys Chariots de service inox - Servicewagen aus Edelstahl

Struttura tubolare acciaio inox tonda Ø 25, alto spessore con piani stampati in forma di vassoio con bordi arrotondati - insonorizzati con finitura satinata - Ruote multidirezionali. Paracolpi in gomma. Portata complessiva Kg 150.

Extra thick tubular stainless steel structure Ø 25. Tray - shape moulded shelves. Rounded edges. Anti-noise satined finish. Multidirectional wheels. Rubber buffer. Total capacity 150 Kg.

Structure en acier inox tubulaire de haute épaisseur Ø 25. Rayons estampés a forme de plateau. Bord arrondi. Finissage satiné anti-bruit. Roues pivotantes. Butoir en gomme. Portée totale 150 Kg.

Gestell aus sehr starkem, viereckigem Stahlrohr Ø 25, bedruckte, tabletförmige Platten mit abgerundeten Kanten, schallgegedämmt, mit satiniertes Oberfläche. Leichtlaufende Rollen Gummipuffer. Tragfähigkeit 150 Kg.



CA 1430

€ 380,00

DIMENSIONI ESTERNE LxPxH cm
EXTERNAL DIMENSIONS LxPxH cm
DIMENSIONS EXTERIEURES LxPxH cm
AUBENABMESSUNGEN LxPxH cm

109x59x100h
2 piani / 2 Shelves
2 Rayons / 2 Platten



CA 1431

€ 450,00

DIMENSIONI ESTERNE LxPxH cm
EXTERNAL DIMENSIONS LxPxH cm
DIMENSIONS EXTERIEURES LxPxH cm
AUBENABMESSUNGEN LxPxH cm

109x59x100h
3 piani / 3 Shelves
3 Rayons / 3 Platten

Optionals

SU RICHIESTA SPEDITI ANCHE SMONTATI - ON REQUEST DELIVERED NOT MOUNTED - SUR DEMANDE ENVOYÉS DEMONTÉS - AUF ANFRAGE DEMONTIERT GELIEFERT

Carrelli di servizio inox - Stainless steel service trolleys
Chariots de service inox - Servicewagen aus Edelstahl



CA 1432

€ 550,00

DIMENSIONI ESTERNE LxPxH cm
EXTERNAL DIMENSIONS LxPxH cm
DIMENSIONS EXTERIEURES LxPxH cm
AUBENABMESSUNGEN LxPxH cm

109x59x130h
4 piani / 4 Shelves
4 Rayons / 4 Platten



CA 1433

€ 640,00

DIMENSIONI ESTERNE LxPxH cm
EXTERNAL DIMENSIONS LxPxH cm
DIMENSIONS EXTERIEURES LxPxH cm
AUBENABMESSUNGEN LxPxH cm

109x59x160h
5 piani / 5 Shelves
5 Rayons / 5 Platten

Optionals

A517 Ruote con freno - Wheels with catch - Roues avec frein - Räder mit Bremse

€ 14,00 cad./each

Carrelli di servizio inox trasporto pesante - Stainless steel service trolleys heavy transport Chariots de service inox transport lourd - Servicewagen aus Edelstahl Schwer transport

🇮🇹 Struttura in acciaio inox 25x25. Piano in acciaio inox piegati con omega di rinforzo, satinati, insonorizzati. Ruote multidirezionali. Paracolpi in gomma. Portata complessiva 200 Kg.

🇬🇧 Stainless steel structur. Stainless steel folded, anti-noise and satined shelves with reinforcements. Multidirectional wheels. Rubber buffer. Total capacity 200 Kg.

🇫🇷 Structure en acier inoxydable. Rayons en acier inoxydable, pliés, antibruits et satinés avec bourrelets de renforcement. Roues pivotantes. Butoir en gomme. Portée totale 200 Kg.

🇩🇪 Gestell aus rostfreiem Stahl. Gebogene, schallgedämmte mit satinierte Oberfläche Platten aus rostfreiem Stahl mit verstärkungsrippen. Leichtlaufende Rollen Gummipuffer. Tragfähigkeit 200 Kg.



CA 1393P

€ 415,00

DIMENSIONI ESTERNE LxPxH cm
EXTERNAL DIMENSIONS LxPxH cm
DIMENSIONS EXTERIEURES LxPxH cm
AUBENABMESSUNGEN LxPxH cm

111x66x98h



CA 1395P

€ 565,00

DIMENSIONI ESTERNE LxPxH cm
EXTERNAL DIMENSIONS LxPxH cm
DIMENSIONS EXTERIEURES LxPxH cm
AUBENABMESSUNGEN LxPxH cm

111x66x98h

Optionals

A514

Ruote con freno - Wheels with catch - Roues avec frein - Räder mit Bremse

€ 9,00 cad./each

Dolci, formaggi e antipasti - Cake, cheese and hors d'oeuvres trolley

Chariot pour dessert, fromages et hors d'oeuvres - Kuchen, Käse und Vorspeisen Servierwagen



- Refrigerato con 8 piastre eutettiche adatto per dolci, formaggi, salumi e antipasti. Può contenere n° 5 bacinelle GN 1/4 h 65 e n° 5 1/6 h 65. Portata complessiva kg 80.
- Refrigerated with 8 eutectic plates suitable for desserts, cheese, sausages and hors-d'oeuvres. It can hold 5 GN basins 1/4 H. 65 and 5 1/6 H. 65. Total capacity 80 Kg.
- Réfrigéré à 8 plaques eutectiques, indiqué pour les gâteaux, les fromages, la charcuterie et les hors-d'oeuvres. Peut contenir 5 bacs GN 1/4 h.65 et 5 bacs 1/6 h.65. Portée totale 80 Kg.
- Kühlung mit 8 eutektischen Platten, geeignet für Süßspeisen, Käse, Wurst und Vorspeisen. Kann 5 Schüsseln GN 1/4 h 65 und 5 1/6 h 65 aufnehmen. Tragfähigkeit 80 Kg.

CA 1165

€ 870,00

DIMENSIONI ESTERNE LxPxH cm
EXTERNAL DIMENSIONS LxPxH cm
DIMENSIONS EXTERIEURES LxPxH cm
AUBENABMESSUNGEN LxPxH cm

108x57x103 h



- Struttura in acciaio inox. Piani in acciaio inox piegati, satinati, insonorizzati. Ruote multidirezionali. Paracolpi in gomma. Cupola in plx.
- Stainless steel structur. Stainless steel folded, anti-noise and sated shelves. Multidirectional wheels. Rubber buffer.
- Structure en acier inoxydable. Rayons en acier inoxydable. Rayons en acier inoxydable, pliés, antibruits et satinés. Roues pivotantes. Butoir en gomme.
- Gebogene, Schallgedämmte mit satinierter Oberfläche Platten aus rostfreiem Stahl. Leichtlaufende Rollen Gummipuffer.

CA 1162

€ 540,00

DIMENSIONI ESTERNE LxPxH cm
EXTERNAL DIMENSIONS LxPxH cm
DIMENSIONS EXTERIEURES LxPxH cm
AUBENABMESSUNGEN LxPxH cm

118x57x103h
2 piani / 2 Shelves
2 Rayons / 2 Platten

CA 1163

€ 625,00

DIMENSIONI ESTERNE LxPxH cm
EXTERNAL DIMENSIONS LxPxH cm
DIMENSIONS EXTERIEURES LxPxH cm
AUBENABMESSUNGEN LxPxH cm

118x57x103h
3 piani / 3 Shelves
3 Rayons / 3 Platten

Dolci, formaggi e antipasti - Cake, cheese and hors d'oeuvres trolley **Chariot pour dessert, fromages et hors d'oeuvres - Kuchen, Käse und Vorspeisen Servierwagen**

REGGIPIATTO E CASSETTO PORTAPOSATE OPTIONAL Struttura acciaio inox - Piano in nobilitato con cornice perimetrale in acciaio inox. Ruote multidirezionali Ø125. Paracolpi in gomma. Cupola in plx. Il carrello in foto è con accessori A 100 porta piatti e A 200 cassetto portaposate.

PLATE AND CUTLERY HOLDER ON REQUEST Extra thick squared tubular structure in stainless steel. Two high quality wood veneer shelves with surrounding steel frame. Four multidirectional wheels Ø 125. rubber buffer. The trolley pictured includes accessories A100 plate holder and A200 cutlery tray.

PORTE-ASSIETTE ET PORTE-COUVERTS SUR DEMANDE Structure en acier inox tubulaire carré de haute épaisseur avec deux rayons en similibois et corniche périmétrale en acier inox. Quatre roues pivotantes Ø 125. Butoir en gomme. Le chariot illustré sur la photo est doté des accessoires A100 porte-assiettes et A200 tiroir à couverts.

TELLERHALTER UND BESTECKKASTEN AUF ANFRAGE Struktur aus viereckigen sehr starkem Edelstahl. Zwei Flächen aus verbessertem Holz mit Umfassungsrahmen aus Edelstahl. Vier Multirichträder Ø 125. Gummipuffer. Der Wagen auf dem Photo ist mit Zubehör A100, Tellerhalter, und A200, Besteckkasten.



CA 1320 € 460,00

CA 1320W € 460,00

DIMENSIONI ESTERNE LxPxH cm
EXTERNAL DIMENSIONS LxPxH cm
DIMENSIONS EXTERIEURES LxPxH cm
AUBENABMESSUNGEN LxPxH cm

90x57x103h

CA 1321 € 520,00

CA 1321W € 520,00

DIMENSIONI ESTERNE LxPxH cm
EXTERNAL DIMENSIONS LxPxH cm
DIMENSIONS EXTERIEURES LxPxH cm
AUBENABMESSUNGEN LxPxH cm

110x57x103h

ATTENZIONE! Le foto sono con OPTIONAL
ATTENTION! Photos shown on the catalogue are with OPTIONAL
ATTENTION! Les photos sur le catalogue sont avec OPTIONAL
ACHTUNG! Die Photo auf dem Katalog sind EXTRAUSSTATTUNG

Optionals

A100 CA1320 - CA1321 - CA1152 - CA1154 € 50,00

A100W CA1320W - CA1321W - CA1152W - CA1154W € 50,00

Pianetto reggipiatto a scomparsa
Rollaway dish holder surface
Petit plateau porte assiette coulissant
Kleine verschwindbare Fellerhalterplatte

Optionals

A200 CA1320 - CA1321 - CA1152 - CA1154 € 80,00

A200W CA1320W - CA1321W - CA1152W - CA1154W € 80,00

Cassetto portaposate a 3 scomparti
3 buckets cutlery tray
Panier à couverts à 3 compartiments
Besteckkasten mit 3 Fächer

Dolci, formaggi e antipasti - Cake, cheese and hors d'oeuvres trolley

Chariot pour dessert, fromages et hors d'oeuvres - Kuchen, Käse und Vorspeisen Servierwagen



- Cupola in plx semicircolare con coperchi rientranti. Il carrello in foto è con accessori A 100 porta piatti e A 200 cassetto portapastate (optional).
- Semicircular plexiglas dome with re-entering covers. The trolley pictured includes accessories A100 plate holder and A200 cutlery tray (optional).
- Cloche en plexiglas semi-circulaire à couvercles rentrants. Le chariot illustré sur la photo est doté des accessoires A100 porte-assiettes et A200 tiroir à couverts (optional).
- Halbrunde Kuppel aus Plexiglas mit zurücktretenden Deckeln. Der Wagen auf dem Photo ist mit Zubehör A100, Tellerhalter, und A200, Besteckkasten (extra ausstattung).

CA 1152 € 440,00

CA 1152W € 440,00

DIMENSIONI ESTERNE - EXTERNAL DIMENSIONS LxPxH cm 90x57x112h
DIMENSIONS EXTERIEURES - AUßENABMESSUNGEN LxPxH cm

CA 1154 € 470,00

CA 1154W € 470,00

DIMENSIONI ESTERNE - EXTERNAL DIMENSIONS LxPxH cm 110x57x112h
DIMENSIONS EXTERIEURES - AUßENABMESSUNGEN LxPxH cm

ATTENZIONE! Le foto sono con OPTIONAL / **ATTENTION!** Photos shown on the catalogue are with OPTIONAL
ATTENTION! Les photos sur le catalogue sont avec OPTIONAL / **ACHTUNG!** Die Photo auf dem Katalog sind EXTRAUSSTATTUNG



- Struttura in acciaio inox. Piani in acciaio inox stampati, satinati, insonorizzati. Ruote multidirezionali. Paracolpi in gomma. Cupola in plx semicircolare.
- Stainless steel structure. Glazed, soundproof and stainless steel shaped shelves. Multi-directional wheels. Rubber bumpers. Plexiglass semicircular cover.
- Structure en acier inox. Etagères en acier inox imprimées, satinées, insonorisées. Roues pivotantes. Butoirs en caoutchouc. Couvercle semi-circulaire en plexiglas.
- Struktur aus Edelstahl. Polierte, schalldichte, gedruckte Etagen aus Edelstahl. Multi-direktionale Rollen. Gummipuffer. Plexiglas halbkreisförmiger Deckel.

CA 1390C € 430,00

DIMENSIONI ESTERNE - EXTERNAL DIMENSIONS LxPxH cm 92x59x108h
DIMENSIONS EXTERIEURES - AUßENABMESSUNGEN LxPxH cm

CA 1391C € 460,00

DIMENSIONI ESTERNE - EXTERNAL DIMENSIONS LxPxH cm 112x59x108h
DIMENSIONS EXTERIEURES - AUßENABMESSUNGEN LxPxH cm

Carrelli ed espositori refrigerati
Carrelli, Tavole, Distributori Termici
Carrelli termici con resistenza a secco
Scalda tegamini / Scaldabiberon con resistenza a secco
Carrelli termici bagnomaria
Scalda tegamini - Scaldabiberon - Bagnomaria
Carrello Termico Armadiato Bagnomaria
Distributore per prime colazioni



Refrigerated trolleys and display cases
Trolleys, Tables, Thermal distributors
Thermal trolleys with dry heating element
Pot warmers / Bottle warmers with dry heating element
Thermal double boiler trolleys
Pot warmers - Bottle warmers - Double boiler
Thermal Double Boiler Trolley With Cabinet
Breakfast distributor



Chariots et présentoirs réfrigérés
Chariots, Tables, Distributeurs thermiques
Chariots thermiques avec résistance à sec
Chauffe-poêles / Chauffe-biberons avec résistance à sec
Chariots thermiques bain-marie
Chauffe-poêles - Chauffe-biberons - Bain-marie
Chariot Thermique Bain-Marie Avec Armoire
Distributeur pour petits-déjeuners





Wagen und gekühlter Ausstellungswagen
Thermo, Wagen, Tische, Ausgabevorrichtungen
Thermowagen mit trockenem thermoelement
Topfwärmer / Milchfläschchenwärmer mit trockenem thermoelement
Thermowagen für wasserbäder
Topfwärmer - Milchfläschchenwärmer - Wasserbäder
Thermo-Schrankwagen Für Wasserbäder
Ausgabevorrichtung für frühstück



Vasche inox refrigerate da incasso - Built-in stainless steel refrigerated containers

Cuves inox réfrigérés à emboîter - Gekülte Wannen aus rostfreiem Stahl um Zu Einlassen

 Struttura in acciaio inox AISI 304. Pannelli esterni in lamiera galvanizzata. Spessore isolamenti 50 mm. Refrigerazione statica. Gruppo incorporato nel vano inferiore, Controllo temperatura elettronico con termostato digitale. Sbrinatorio automatico, evaporazione dell'acqua di condensa automatico. Gas R314A 220/240V - 50Hz - 340W - 2,8KW/24 h.

 Stainless steel aisi 304 structure. External panels in galvanized sheet steel insulation thickness 50 mm static refrigeration. Gas unit incorporated in the lower space. Electronic temperature control with digital thermostat. Auto matic defrosting and automatic evaporation of condensation. Fas R 314 A 220/240 V - 50 Hz - 340 W - 2,8 Kw / 24 h.



 Structure en acier inox aisi 304 panneaux extérieurs en tôle galvanisée. Epaisseur d'isolation 50 mm. Réfrigération statique. groupe intégré dans lecompartiment inférieur. Contrôle électronique de la temperature avec thermostat digital. Dégivrage et evaporation de l'eau de condensation automatiques. Gas R 314 A 220/240 V - 50 Hz - 340 W - 2,8 Kw / 24 h.

 Gestell aus rostfreiem Stahl aisi 304. Externe Seitenpaneele aus galvanisiertem Blech. Isolirung 50 mm. Statische Kühlung. Gas gruppe im unterem Fach eingebaut. Elektronische Temperaturkontrolle mit digitalem thermostat. Automatische Evaporation des Kondenswassers. Gas R 314 A 220/240 V - 50 Hz - 340 W - 2,8 Kw / 24 h.

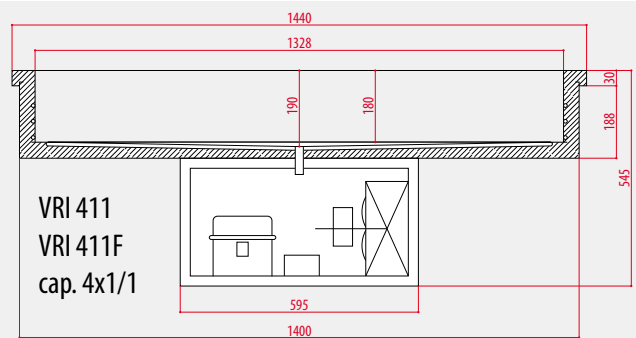

VRI 211

€ 1.000,00

DIMENSIONI ESTERNE - EXTERNAL DIMENSIONS LxPxH cm
DIMENSIONS EXTERIEURES - AUBENABMESSUNGEN LxPxH cm

Vasca 2x1/1 GN
150 h (+2° +8°C)

VRI 311

€ 1.100,00

DIMENSIONI ESTERNE - EXTERNAL DIMENSIONS LxPxH cm
DIMENSIONS EXTERIEURES - AUBENABMESSUNGEN LxPxH cm

Vasca 3x1/1 GN
150 h (+2° +8°C)

VRI 411

€ 1.160,00

DIMENSIONI ESTERNE - EXTERNAL DIMENSIONS LxPxH cm
DIMENSIONS EXTERIEURES - AUBENABMESSUNGEN LxPxH cm

Vasca 4x1/1 GN
150 h (+2° +8°C)

VRI 311F

€ 1.360,00

DIMENSIONI ESTERNE - EXTERNAL DIMENSIONS LxPxH cm
DIMENSIONS EXTERIEURES - AUBENABMESSUNGEN LxPxH cm

Vasca 3x1/1 GN
150 h (-5° +5°C)

VRI 411F



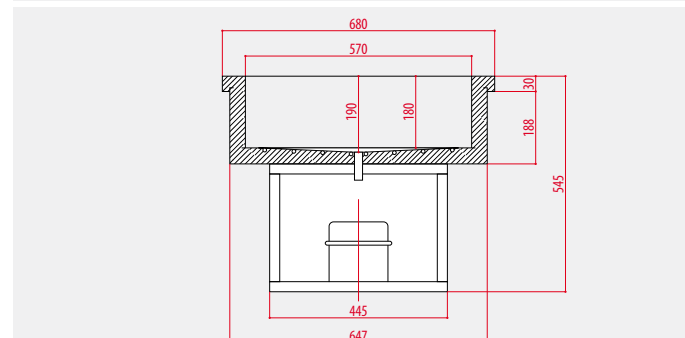
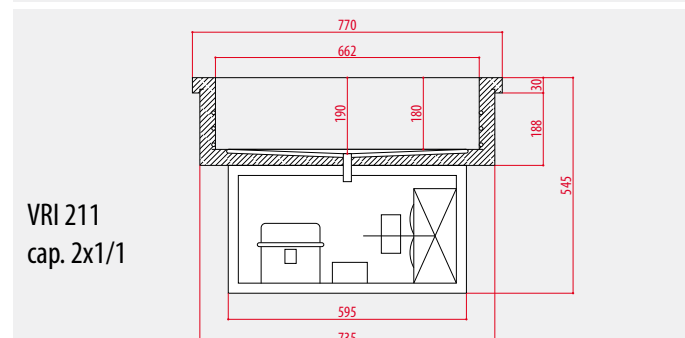
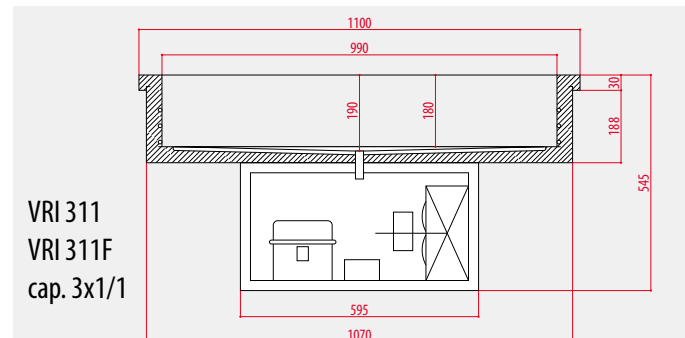

€ 1.490,00

DIMENSIONI ESTERNE - EXTERNAL DIMENSIONS LxPxH cm
DIMENSIONS EXTERIEURES - AUBENABMESSUNGEN LxPxH cm

Vasca 4x1/1 GN
150 h (-5° +5°C)



Vasche inox bagnaroma da incasso - Stainless steel built-in bain-marie tanks Cuves inox bain-marie à emboîter - Einbaubecken aus rostfreiem Stahl für Bain-Marie

-  Vasca in acciaio inox per contenitori gastronorm 1/1 munita di scarico, centralina controllo temperatura da +30° a +90°C 230V 50/60 Hz, resistenza da 2000W, pannello porta centralina, cavi elettrici.
-  Stainless steel tank for 1/1 gastronorm containers with drain, temperature control unit from +30 °to +90 °C 230V 50/60 Hz, resistance 2000W, control unit panel , electrical cables.
-  Cuve en acier inoxydable pour les bacs GN 1/1 avec vidange, platine de contrôle de la température de +30 °à +90 °C 230V 50/60 Hz, résistance 2000W, panneau pour platine, câbles électriques.
-  Einbaubecken aus rostfreiem Stahl für GN 1/1 Behälter mit Auslass, mit Temperaureinrichtung von +30° bis +90°C 230V 50/60 Hz mit 2000W Widerstand, Platte für Steuereinheit, elektrische Kabel.



VBC 211

€ 600,00

DIMENSIONI ESTERNE - EXTERNAL DIMENSIONS LxPxH cm
DIMENSIONS EXTERIEURES - AUBENABMESSUNGEN LxPxH cm

Vasca 2x1/1 GN
150 h (+30° +90°C)

VBC 311

€ 650,00

DIMENSIONI ESTERNE - EXTERNAL DIMENSIONS LxPxH cm
DIMENSIONS EXTERIEURES - AUBENABMESSUNGEN LxPxH cm

Vasca 3x1/1 GN
150 h (+30° +90°C)

VBC 411

€ 700,00

DIMENSIONI ESTERNE - EXTERNAL DIMENSIONS LxPxH cm
DIMENSIONS EXTERIEURES - AUBENABMESSUNGEN LxPxH cm

Vasca 4x1/1 GN
150 h (+30° +90°C)

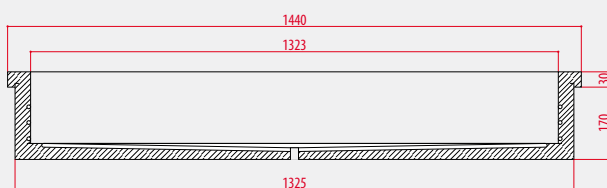

VBC 411 - cap. 4x1/1

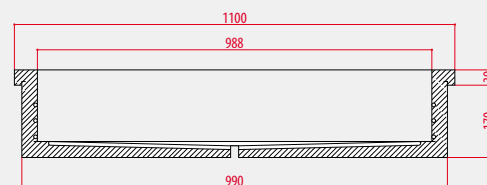

VBC 311 - cap. 3x1/1

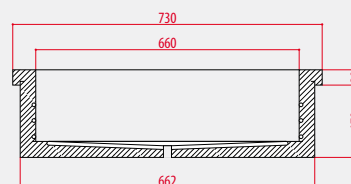

VRI 211 - cap. 2x1/1

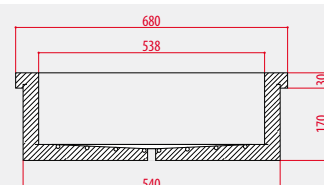



VISTA LATERALE

Carrelli ed espositori refrigerati - Refrigerated trolleys and display cases

Chariots et présentoirs réfrigérés - Wagen und gekühlter Ausstellungswagen

 **CARRELLO REFRIGERATO.** Struttura interamente in acciaio inox Temperatura +2° +10°C Capacità n° 3 x GN 1/1 h. 150 Alimentazione 230V/1N/50Hz 250W Gas refrigerante R134A (bacinelle escluse).

 **REFRIGERATED TROLLEY.** Stainless steel frame Temperature +2° +10°C Capacity nos. 3 x GN 1/1 h. 150 Power 230V/1N/50Hz 250W Refrigerant R134A (containers not included).

 **CHARIOT RÉFRIGÉRÉ.** Structure en acier inox Température +2° +10°C Capacité nos. 3 x GN 1/1 h. 150 Alimentation 230V/1N/50Hz 250W Gaz réfrigérant R134A (bacs exclus).

 **KÜHLWAGEN.** Aufbau aus Edelstahl Temperatur +2° +10°C Kapazität 3 x GN 1/1 h. 150 Beschickung 230V/1N/50Hz 250W Kühlgas R134A (Schüsseln Ausgenommen).



CAR 2780 (+2° +10°C)

€ 2.480,00

CAR 2780BT (-5° +5°C)

€ 2.650,00

DIMENSIONI ESTERNE LxPxH cm
EXTERNAL DIMENSIONS LxPxH cm
DIMENSIONS EXTERIEURES LxPxH cm
AUBENABMESSUNGEN LxPxH cm

124x72x126 h

CAR 2779 (+2° +10°C)

€ 2.150,00

DIMENSIONI ESTERNE LxPxH cm
EXTERNAL DIMENSIONS LxPxH cm
DIMENSIONS EXTERIEURES LxPxH cm
AUBENABMESSUNGEN LxPxH cm

124x72x94 h

- 🇮🇹 **CARRELLI TERMICI CON RESISTENZA A SECCO** (senza acqua). Struttura in acciaio inox. Vasca a doppia parete. Termostato regolabile 30°-90°C, alimentazione V230 50/60 Hz. Interruttore accensione con spia luminosa, spia luminosa di riscaldamento in atto. Ruote piroettanti paracolpi e maniglia direzionale (bacinelle escluse).
- 🇬🇧 **THERMAL TROLLEYS WITH DRY HEATING ELEMENT** (without water). Stainless steel structure. Double layer basin. Adjustable thermostat 30°-90°C. Mains supply: 230 V 50/60 Hz. Switch with warning light to indicate the heat is on. Multidirectional wheels. Buffers and pushing handle (containers not included).
- 🇫🇷 **CHARIOTS THERMIQUES AVEC RESISTANCE À SEC** (sans eau). Structure en acier inox. Cuve à double paroi. Thermostat réglable 30°-90°C. Alimentation 230 V 50/60 Hz. Interrupteur d'allumage avec lampe témoin, voyant de chauffage en état de marche. Roues pivotantes. Butoirs et poignée de direction (bacs exclus).
- 🇩🇪 **THERMOWAGEN MIT TROCKEM THERMOELEMENT** (ohne Wasser). Gestell aus rostfreiem Stahl. Becken mit doppelten Wänden. Regulierbares Thermostat: 30°-90°C, Beschickung: 230 V 50/60 Hz. Einschalter mit Kontrolllampe. Aufwärm-Kontrolllampe. Pirouettierende Rollen. Puffer und Handgriff (Schüsseln Ausgenommen).

- 🇮🇹 **SCALDA TEGAMINI / SCALDA BIBERON CON RESISTENZA A SECCO** (senza acqua). Struttura in acciaio inox. Vasca a doppia parete. Termostato regolabile 30°-90°C, alimentazione V230 50/60 Hz. Interruttore accensione con spia luminosa, spia luminosa di riscaldamento in atto. Ruote piroettanti paracolpi e maniglia direzionale (bacinelle escluse).
- 🇬🇧 **POT WARMES / BOTTLE WARMES WITH DRY HEATING ELEMENT** (without water). Sstainless steel structure. Double layer basin. Adjustable thermostat 30°-90°C. Main supply: 230V 50/60 Hz. Switch with warning light to indicate the heat is on. Multidirectional wheels. Buffers and pushing handle (containers not included).
- 🇫🇷 **CHAUFFE-POÊLES / CHAUFFE-BIBERONS AVEC RÉSISTANCE À SEC** (sans eau). Structure en acier inoxydable. Cuve à double paroi. Thermostat réglable 30°-90°C. Alimentation 230V 50/60 Hz. Interrupteur d'allumage avec lampe témoin, voyant de chauffage en état de marche. Roues pivotantes. Butoirs et poignée de direction (bacs exclus).
- 🇩🇪 **TOPFWÄRMER / MILCHFLÄSCHCHENWÄRMER MIT TROCKEM THERMOELEMENT** (ohne Wasser). Gestell aus rostfreiem Stahl. Becken mit doppelten Wänden. Regulierbares Thermostat: 30°-90°C, Beschickung: 230V 50/60 Hz. Einschalter mit Kontrolllampe. Aufwärm-Kontrolllampe. Pirouettierende Rollen. Puffer und Handgriff (Schüsseln Ausgenommen).



CTS 1757 (1x1/1GN)

€ 650,00

DIMENSIONI ESTERNE LxPxH cm
EXTERNAL DIMENSIONS LxPxH cm
DIMENSIONS EXTERIEURES LxPxH cm
AUGENABMESSUNGEN LxPxH cm

56x65x85h
1x1/1 GN 200h
1000 W



CSS 1750 (1x1/1GN)

€ 730,00

DIMENSIONI ESTERNE LxPxH cm
EXTERNAL DIMENSIONS LxPxH cm
DIMENSIONS EXTERIEURES LxPxH cm
AUGENABMESSUNGEN LxPxH cm

56x65x85h
1x1/1 GN
1000 W

CTS 1759 (2x1/1GN)

€ 750,00

DIMENSIONI ESTERNE LxPxH cm
EXTERNAL DIMENSIONS LxPxH cm
DIMENSIONS EXTERIEURES LxPxH cm
AUGENABMESSUNGEN LxPxH cm

84x65x85h
2x1/1 GN 200h
1000 W

CSS 1752 (2x1/1GN)

€ 880,00

DIMENSIONI ESTERNE LxPxH cm
EXTERNAL DIMENSIONS LxPxH cm
DIMENSIONS EXTERIEURES LxPxH cm
AUGENABMESSUNGEN LxPxH cm

84x65x85h
2x1/1 GN
1000 W

CTS 1761 (3x1/1GN)

€ 850,00

DIMENSIONI ESTERNE LxPxH cm
EXTERNAL DIMENSIONS LxPxH cm
DIMENSIONS EXTERIEURES LxPxH cm
AUGENABMESSUNGEN LxPxH cm

117x65x85h
3x1/1 GN 200h
2000 W

CSS 1754 (3x1/1GN)

€ 960,00

DIMENSIONI ESTERNE LxPxH cm
EXTERNAL DIMENSIONS LxPxH cm
DIMENSIONS EXTERIEURES LxPxH cm
AUGENABMESSUNGEN LxPxH cm

117x65x85h
3x1/1 GN
2000 W

Carrelli termici bagnomaria - Thermal double boiler trolleys

Chariots thermiques bain-marie - Thermowagen für wasserbäder

- CARRELLI TERMICI BAGNOMARIA.** Struttura in acciaio inox. Vasca a doppia parete provvista di rubinetto di scarico posto sul fondo. Termostato regolabile 30°-90°C. Alimentazione W2000 V230 50/60 Hz. Interruttore accensione con spia luminosa, spia luminosa di riscaldamento in atto. Termostato limite. Ruote piroettanti paracolpi e maniglia direzionale (bacinelle escluse).
- THERMAL DOUBLE BOILER TROLLEYS.** Stainless steel structure. Double layer basin. Bottom equipped with drain on the bottom tap. 30°-90°C, adjustable thermostat. Main supply: W2000 230V 50/60 Hz. Switch with warning light to indicate the heat is on. Thermostat limit. Multidirectional wheels. Buffers and pushing handle (containers not included).
- CHARIOTS THERMIQUES BAIN-MARIE.** Structure en acier inox. Cuve à double paroi équipée de tuyau de vidange sur le fond. Thermostat réglable 30°-90°C. Alimentation W2000 230V 50/60 Hz. Interrupteur d'allumage avec lampe témoin, voyant de chauffage en état de marche. Thermostat limite. Roues pivotantes. Butoirs et poignée de direction (bacs exclus).
- THERMOWAGEN FÜR WASSERBÄDER.** Gestell aus rostfreiem Stahl. Becken mit doppelten Wänden mit Ablasshahn am Boden. Regulierbares Thermostat: 30°-90°C, Beschickung: W2000 230V 50/60 Hz. Einschalter mit Kontrolllampe, Aufwärm-Kontrolllampe. Beschränkenden Thermostat. Pirouettierende Rollen. Puffer und Handgriff (Schüsseln Ausgenommen).



CT 1756 (1x1/1 GN) € 640,00

DIMENSIONI ESTERNE LxPxH cm - EXTERNAL DIMENSIONS LxPxH cm **56x65x85h**
DIMENSIONS EXTERIEURES LxPxH cm - AUßENABMESSUNGEN LxPxH cm **1x1/1 GN 200h**

CT 1758 (2x1/1 GN) € 740,00

DIMENSIONI ESTERNE LxPxH cm - EXTERNAL DIMENSIONS LxPxH cm **84x65x85h**
DIMENSIONS EXTERIEURES LxPxH cm - AUßENABMESSUNGEN LxPxH cm **2x1/1 GN 200h**

CT 1760 (3x1/1 GN) € 800,00

DIMENSIONI ESTERNE LxPxH cm - EXTERNAL DIMENSIONS LxPxH cm **117x65x85h**
DIMENSIONS EXTERIEURES LxPxH cm - AUßENABMESSUNGEN LxPxH cm **3x1/1 GN 200h**

CT 1762 (4x1/1 GN) € 950,00

DIMENSIONI ESTERNE LxPxH cm - EXTERNAL DIMENSIONS LxPxH cm **148x65x85h**
DIMENSIONS EXTERIEURES LxPxH cm - AUßENABMESSUNGEN LxPxH cm **4x1/1 GN 200h**

- SCALDA TEGAMINI - SCALDA BIBERON - BAGNOMARIA.** Struttura in acciaio inox. Vasca a doppia parete provvista di rubinetto di scarico posto sul fondo. Termostato regolabile 30°-90°C, alimentazione W2000 V230 50/60 Hz. Interruttore accensione con spia luminosa, spia luminosa di riscaldamento in atto. Termostato limite. Ruote piroettanti paracolpi e maniglia direzionale (bacinelle escluse).
- POT WARMERS - BOTTLE WARMERS - DOUBLE BOILER.** Stainless steel structure. Double layer basin. Equipped with drain on the bottom tap. 30°-90°C adjustable thermostat. Main supply: W2000 230V 50/60 Hz. Switch with warning light to indicate the heat is on. Thermostat limit. Multidirectional wheels. Buffers and pushing handle (containers not included).
- CHAUFFE-POÊLES - CHAUFFE-BIBERONS - BAIN-MARIE.** Structure en acier inoxydable. Cuve à double paroi équipée de tuyau de vidange sur le fond. Thermostat réglable 30°-90°C, alimentation W2000 230V 50/60 Hz, Interrupteur d'allumage avec lampe témoin, voyant de chauffage en état de marche. Thermostat limite. Roues pivotantes. Butoirs et poignée de direction (bacs exclus).
- TOPFWÄRMER - MILCHFLÄSCHENWÄRMER - WASSERBÄDER.** Gestell aus rostfreiem Stahl. Becken mit doppelten Wänden mit Ablasshahn am Boden. Regulierbares Thermostat: 30°-90°C, beschickung: W2000 230V 50/60 Hz W. Einschalter mit Kontrolllampe. Beschränkenden Thermostat. Aufwärm-Kontrolllampe. Pirouettierende Rollen. Puffer und Handgriff (Schüsseln Ausgenommen).



CS 1751 (1x1/1 GN) € 720,00

DIMENSIONI ESTERNE LxPxH cm - EXTERNAL DIMENSIONS LxPxH cm **56x65x85h**
DIMENSIONS EXTERIEURES LxPxH cm - AUßENABMESSUNGEN LxPxH cm **1x1/1 GN 200h**

CS 1753 (2x1/1 GN) € 840,00

DIMENSIONI ESTERNE LxPxH cm - EXTERNAL DIMENSIONS LxPxH cm **84x65x85h**
DIMENSIONS EXTERIEURES LxPxH cm - AUßENABMESSUNGEN LxPxH cm **2x1/1 GN 200h**

CS 1755 (3x1/1 GN) € 900,00

DIMENSIONI ESTERNE LxPxH cm - EXTERNAL DIMENSIONS LxPxH cm **117x65x85h**
DIMENSIONS EXTERIEURES LxPxH cm - AUßENABMESSUNGEN LxPxH cm **3x1/1 GN 200h**

Carrelli termici bagnomaria - Thermal double boiler trolleys Chariots thermiques bain-marie - Thermowagen für wasserbäder

 CARRELLI TERMICI BAGNOMARIA CON TEMPERATURA DIFFERENZIATA. Struttura in acciaio inox. Vasca a doppia parete provvista di rubinetto di scarico posto sul fondo. Termostato regolabile 30°-90°C. Alimentazione W2000 V230 50/60 Hz. Interruttore accensione con spia luminosa, spia luminosa di riscaldamento in atto. Termostato limite. Ruote piroettanti paracolpi e maniglia direzionale (bacinelle escluse).

 THERMAL DOUBLE BOILER TROLLEYS WITH DIFFERENTIATED TEMPERATURES. Stainless steel structure. Double layer basin. Bottom equipped with drain on the bottom tap. 30°-90°C, adjustable thermostat. Main supply: W2000 230V 50/60 Hz. Switch with warning light to indicate the heat is on. Thermostat limit. Multidirectional wheels. Buffers and pushing handle (containers not included).

 CHARIOTS THERMIQUES BAIN-MARIE AVEC TEMPERATURES DIFFERENCIÉES. Structure en acier inox. Cuve à double paroi équipée de toyant de vidange sur le fond. Thermostat réglable 30°-90°C. Alimentation W2000 230V 50/60 Hz. Interrupteur d'allumage avec lampe témoin, voyant de chauffage en état de marche. Thermostat limite. Roues pivotantes. Butoirs et poignée de direction (bacs exclus).

 THERMOWAGEN FÜR WASSERBÄDER MIT VERSCHIEDENEN TEMPERATUREN. Gestell aus rostfreiem Stahl. Becken mit doppelten Wänden mit Ablasshahn am Boden. Regulierbares Thermostat: 30°-90°C, Beschickung: W2000 230V 50/60 Hz. Einschalter mit Kontrolllampe, Aufwärm-Kontrolllampe. Beschränkenden Thermostat. Pirouettierende Rollen. Puffer und Handgriff (Schüsseln Ausgenommen).



CT 1758TD (2x1/1 GN)

€ 820,00

DIMENSIONI ESTERNE LxPxH cm
EXTERNAL DIMENSIONS LxPxH cm
DIMENSIONS EXTERIEURES LxPxH cm
AUBENABMESSUNGEN LxPxH cm

84x65x85h
N° 2x1/1 GN 150h
2000 W

CT 1760TD (3x1/1 GN)

€ 1.050,00

DIMENSIONI ESTERNE LxPxH cm
EXTERNAL DIMENSIONS LxPxH cm
DIMENSIONS EXTERIEURES LxPxH cm
AUBENABMESSUNGEN LxPxH cm

117x67x85h
N° 3x1/1 GN 150h
3000 W



CARRELLI TERMICI BAGNOMARIA CON CUPOLA SEMICIRCOLARE
THERMAL BAIN-MARIE TROLLEYS WITH SEMICIRCULAR CAP
CHARIOTS BAIN-MARIE THERMIQUES AVEC DÔME SEMI-CIRCULAIRE
BAIN-MARIE THERMOWAGEN MIT HALBKREISFÖRMIGEM DECKEL

CT 1760C (3x1/1 GN)

€ 1.120,00

DIMENSIONI ESTERNE LxPxH cm
EXTERNAL DIMENSIONS LxPxH cm
DIMENSIONS EXTERIEURES LxPxH cm
AUBENABMESSUNGEN LxPxH cm

117x67x114h
N° 3x1/1 GN 200h
2000 W

Carrelli termici bagnomaria - Thermal double boiler trolleys

Chariots thermiques bain-marie - Thermowagen für wasserbäder

🇮🇹 CARRELLO TERMICO ARMADIATO BAGNOMARIA. Interamente costruito in acciaio inox AISI 304 18/10. Il vano superiore, in doppia parete coibentata, è dotato di rubinetto di scarico sul fondo. Il carrello è atto a contenere bacinelle GN fino ad una profondità di cm 20. Il vano inferiore è chiuso da antine. I coperchi sono apribili a compasso fino a 180° per formare un comodo piano di appoggio. Riscaldamento a bagnomaria mediante resistenza elettrica. 4 ruote di cui 2 piroettanti con freno 2 fisse (bacinelle escluse).

🇬🇧 THERMAL DOUBLE BOILER TROLLEY WITH CABINET. Made entirely in 18/10 AISI. 304 stainless steel. The upper compartment with double insulated walls has a drain tap at the bottom. The trolley is designed to hold GN containers up to a depth of 20 cm. The lower cupboard is closed with doors. The hinged covers can be opened to 180° to form a convenient support surface. Water-bath heating with electrical element. 4 wheels of which 2 multidirectional with brake and 2 fixed (containers excluded).

🇫🇷 CHARIOT THERMIQUE BAIN-MARIE AVEC ARMOIRE. Chariot en acier inox AISI 304 18/10. Le compartiment supérieur, à double paroi isothermique, est doté d'un robinet pour liévacuation sur le fond. Le chariot peut contenir des cuvettes GN d'une profondeur maximale de 20 cm. Le compartiment inférieur est fermé par des portes. Les couvercles du compartiment supérieur s'ouvrent à 180° formant un plan d'appui très pratique. Chauffage à bain-marie au moyen d'une résistance électrique. 4 roues dont 2 pivotantes avec frein et 2 fixes (conteneurs exclus).

🇩🇪 THERMO-SCHRANKWAGEN FÜR WASSERBÄDER. Thermo-Schrankwagen. Innen aus rostfreiem Stahl AISI 304 18/10. Der obere Raum besitzt eine doppelte Dämmwand und einen Auslaßhahn am Boden. Der Wagen eignet sich für die Aufnahme von Gastronorm-Schalen bis zu einer Tiefe von 20 cm. Der untere Raum ist durch Flügel geschlossen. Die Deckel gehen im Winkel bis 180° auf und bilden so eine bequeme Abstellfläche. Wasserbad-Erwärmung durch elektrischen Widerstand. 4 Räder, 2 davon leichtlaufende mit Bremse und 2 feste (Behälter ausgeschlossen).



CT 1766 (2x1/1 GN)

€ 1.650,00

DIMENSIONI ESTERNE LxPxH cm
EXTERNAL DIMENSIONS LxPxH cm
DIMENSIONS EXTERIEURES LxPxH cm
AUBENABMESSUNGEN LxPxH cm

96x68x92h
2x1/1 GN 200h
230V 50/60 Hz
2400 W

CT 1771 (3x 1/1 GN)

€ 1.950,00

DIMENSIONI ESTERNE LxPxH cm
EXTERNAL DIMENSIONS LxPxH cm
DIMENSIONS EXTERIEURES LxPxH cm
AUBENABMESSUNGEN LxPxH cm

130x68x92h
3x1/1 GN 200h
230V 50/60 Hz
2400 W

Optionals

A700

Vano inferiore riscaldato (W.600) - Lower compartment heated - Compartiment inferieur chauffé - Erwärmter Unterer Raum

€ 166,00

Carrelli termici bagnomaria - Thermal double boiler trolleys Chariots thermiques bain-marie - Thermowagen für wasserbäder



CT 1765 (2x1/1 GN)

€ 2.150,00

DIMENSIONI ESTERNE LxPxH cm
EXTERNAL DIMENSIONS LxPxH cm
DIMENSIONS EXTERIEURES LxPxH cm
AUBENABMESSUNGEN LxPxH cm

96x68x102h
2x1/1 GN 200h
230V 50/60 Hz
2400 W

CT 1770 (3x1/1 GN)

€ 2.450,00

DIMENSIONI ESTERNE LxPxH cm
EXTERNAL DIMENSIONS LxPxH cm
DIMENSIONS EXTERIEURES LxPxH cm
AUBENABMESSUNGEN LxPxH cm

130x68x102h
3x1/1 GN 200h
230V 50/60 Hz
2400 W



CARRELLI TERMICI BAGNOMARIA CON TEMPERATURA DIFFERENZIATA
THERMAL DOUBLE BOILER TROLLEYS WITH DIFFERENTIATED TEMPERATURES
CHARIOTS THERMIQUES BAIN-MARIE AVEC TEMPERATURES DIFFERENCIEES
THERMOWAGEN FÜR WASSERBÄDER MIT VERSCHIEDENEN TEMPERATUREN

CT 1766 TD (2x1/1 GN)

€ 1.800,00

DIMENSIONI ESTERNE LxPxH cm
EXTERNAL DIMENSIONS LxPxH cm
DIMENSIONS EXTERIEURES LxPxH cm
AUBENABMESSUNGEN LxPxH cm

96x68x92h
2x1/1 GN 200h
230V 50/60 Hz
2400 W

CT 1771 TD (3x1/1 GN)

€ 2.250,00

DIMENSIONI ESTERNE LxPxH cm
EXTERNAL DIMENSIONS LxPxH cm
DIMENSIONS EXTERIEURES LxPxH cm
AUBENABMESSUNGEN LxPxH cm

130x68x92h
3x1/1 GN 200h
230V 50/60 Hz
W 2400

Optionals

A700

Vano inferiore riscaldato (W.600) - Lower compartment heated - Compartiment inferieur chauffé - Erwärmter Unterer Raum

€ 166,00

Carrelli termici bagnomaria - Thermal double boiler trolleys
Chariots thermiques bain-marie - Thermowagen für wasserbäder



CT 1765 TD (2x1/1 GN)

€ 2.250,00

DIMENSIONI ESTERNE LxPxH cm
 EXTERNAL DIMENSIONS LxPxH cm
 DIMENSIONS EXTERIEURES LxPxH cm
 AUBENABMESSUNGEN LxPxH cm

96x68x102h
2x1/1 GN 200h
230V 50/60 Hz
2400 W

CT 1770 TD (3x1/1 GN)

€ 2.600,00

DIMENSIONI ESTERNE LxPxH cm
 EXTERNAL DIMENSIONS LxPxH cm
 DIMENSIONS EXTERIEURES LxPxH cm
 AUBENABMESSUNGEN LxPxH cm

130x68x102h
3x1/1 GN 200h
230V 50/60 Hz
2400 W





DIMENSIONI ESTERNE LxPxH cm
 EXTERNAL DIMENSIONS LxPxH cm
 DIMENSIONS EXTERIEURES LxPxH cm
 AUBENABMESSUNGEN LxPxH cm

170x68x102h mod. (2x1/1 GN)
237x68x102h mod. (3x1/1 GN)



Carrelli termici bagnomaria - Thermal double boiler trolleys Chariots thermiques bain-marie - Thermowagen für wasserbäder

 **DISTRIBUTORE PER PRIME COLAZIONI.** Distributore interamente in acciaio inox AISI 304 18/10 con vasca doppia parete. Pentole in acciaio inox AISI 304 18/10 da lt 15 cad. complete di coperchio. Rubinetti in plastica facilmente smontabili per la pulizia quotidiana. Riscaldamento mediante resistenza elettrica a bagno-maria W 2000, V230 50/60 Hz regolata da termostato 30°- 90°C e controllata da spia luminosa. Mobiletto di sostegno in acciaio inox, chiuso da ante a battente e provvisto di ripiano intermedio. Ruote piroettanti.

 **BREAKFAST DISTRIBUTOR.** Distributor AISI 304 18/10 stainless steel framework with double wall basin. Stainless steel tanks AISI 304 18/10 of 15 Lt. each, with cover. Plastic taps easy to dismount for cleaning. Bain-marie method-electric immersion heater W 2000, V230 50/60 Hz regulated by means of thermostat 30° 90°C with warning light. Supporting framework in stainless steel, doors and intermediate shelf. Swivelling wheels.

 **DISTRIBUTEUR POUR PETITS-DÉJEUNERS.** Distributeur en acier inox AISI 304 18/10 avec cuve à double paroi. Conteniteurs en acier inox AISI 304 18/10 de 15 Lt. chacun avec couvercle. Robinets en plastique faciles à démonter pour le nettoyage. Chauffage à bain-marie au moyen d'une résistance bndée W 2000, V230 50/60 Hz. Equipé de thermostat 30°- 90°C et lampe témoin. Meuble en acier inox fermé par des antes à battent et pourvu d'une étagère intermediaire. Roues pivotantes.

 **AUSGABEVORRICHTUNG FÜR FRÜHSTÜCK.** Frühstückswagen aus rostfreiem Stahl AISI 304 18/10. Becken mit doppelten Wänden. Töpfe aus Rostfreiem Stahl AISI 304 18/10 zu jeweils 15 Lt. mit Deckel. Für die tägliche Reinigung leicht demontierbare Zapfhähne aus Kunststoff. Erwärmung durch elektrischen Widerstand im Wasserbad 2000, W, V230 50/60 Hz; wird durch Thermostat von 30°- 90°C reguliert und durch Kontrolllampe angezeigt. Zusatzschrankchen aus Edelstahl mit Türklopper und Zwischen-Etage. Pirouettierende Rollen.



DCM 1699

€ 2.300,00

DIMENSIONI ESTERNE LxPxH cm
EXTERNAL DIMENSIONS LxPxH cm
DIMENSIONS EXTERIEURES LxPxH cm
AUBENABMESSUNGEN LxPxH cm

75x41x135h

2 recipienti da lt 15 - 2 urns lt. 15
2 bacs de 15 lt - 2 Kannen zu 15 lt

DCM 1701

€ 2.900,00

DIMENSIONI ESTERNE LxPxH cm
EXTERNAL DIMENSIONS LxPxH cm
DIMENSIONS EXTERIEURES LxPxH cm
AUBENABMESSUNGEN LxPxH cm

106x41x135h

3 recipienti da lt 15 - 3 urns lt. 15
3 bacs de 15 lt - 3 Kannen zu 15 lt

Da appoggio. Vasca recupero liquidi. Caratteristiche come art. DC 1699-1701 senza mobile.

Table appliance. Liquid collection basin. Characteristics as for DC 1699-1701, without unit.

Appareil de table. Cuve de récupération des liquides. Caractéristiques identiques à DC 1699-1701, sans meuble.

Tischgeraet - Flüssigkeitsauffangschale. Eigenschaften wie DC 1699-1701 ohne Möbel.

DC 1704

€ 1.680,00

DIMENSIONI ESTERNE LxPxH cm
EXTERNAL DIMENSIONS LxPxH cm
DIMENSIONS EXTERIEURES LxPxH cm
AUBENABMESSUNGEN LxPxH cm

75x41x71h

2 recipienti da lt 15 - 2 contains 15 lt
2 bacs de 15 lt - 2 Kannen 15 Lt

DC 1703

€ 2.150,00

DIMENSIONI ESTERNE LxPxH cm
EXTERNAL DIMENSIONS LxPxH cm
DIMENSIONS EXTERIEURES LxPxH cm
AUBENABMESSUNGEN LxPxH cm

106x41x71h

3 recipienti da lt 15 - 3 containers 15 lt
3 bacs de 15 lt - 3 Kannen 15 Lt

Carrelli ed espositori refrigerati in legno 
Espositore caldo bagnomaria con cupola
Bolliti e arrosti

Refrigerated wooden trolleys and display cases 
Bain-marie warmed display case with dome
Roast and boiled meat trolley

Chariots et présentoirs réfrigérés en bois 
Présentoir chauffé bain-marie avec cloche
Chariot pour bouillis et rotis

Wagen und gekühlter Ausstellungswagen aus Holz 
Warme wasserbadausstellung mit kuppel
Wagen für Kochfleisch und Braten

Carrelli ed espositori refrigerati - Refrigerated trolleys and display cases

Chariots et présentoirs réfrigérés - Wagen und gekühlter Ausstellungswagen

 **CARRELLO REFRIGERATO IN LEGNO CON CUPOLA IN PLEXIGLASS.** Struttura in legno massello. Cupola in plexiglass. Refrigerazione statica. Temperatura da +2° +10°C con coperchi posizionati. Voltaggio 230 V 50 Hz. Gas refrigerante: R 134 A. Capacità n. 3 gastronorm 1/1 h 150. Dotato di 2 mensole d'appoggio pieghevoli (bacinelle escluse).

 **WOODEN REFRIGERATED CARTS WITH PLEXIGLAS DOMES.** Solid wood frame. Plexiglass cover. Static refrigeration. Temperature between +2° +10°C when covers are positioned. 230 V 50 Hz. Refrigerant: R134A. Capacity: 3 GN 1/1 H. 150. Equipped with two folding shelves (containers not included).

 **CHARIOT RÉFRIGÉRÉ EN BOIS AVEC CLOCHE EN PLEXIGLAS.** Structure en bois massif, couvercle en plexiglass. Réfrigération statique. Température de +2° +10°C avec les couvercles en position. Voltagge 230V 50 Hz. Gaz réfrigérant: R134 A. Capacité 3 GN 1/1 h 150. Equipé de 2 étagères pliables (bacs exclus).

 **KÜHLWAGEN AUS MASSIVEM HOLZ MIT PLEXIGLAS-ABDECKUNG.** Aufbau aus massivem Holz, Abdeckung aus Plexiglas. Statische Kühlung. Temperatur von 2°C bis 10°C (bei geschlossener Abdeckung). Versorgungsspannung 230 V, 50 Hz. Kühlgas: R134A. Kapazität 3 GN 1/1 h 150. Kapazität 3 GN 1/1 h 150. Mit 2 Klappbaren Stützkonsolen ausgestattet (Schüsseln Ausgenommen).



CLR 2788 (+2° +10°C) € 2.750,00

CLR 2788BT (-5° +5°C) € 3.000,00

(Gastronorm 3x1/1 - h 150)

CLR 2788W (+2° +10°C) € 2.750,00

CLR 2788BTW (-5° +5°C) € 3.000,00

(Gastronorm 3x1/1 - h 150)

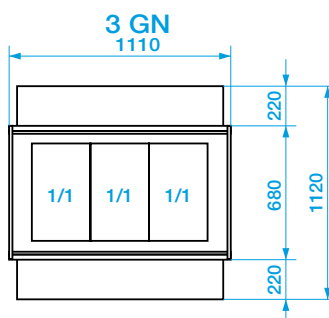
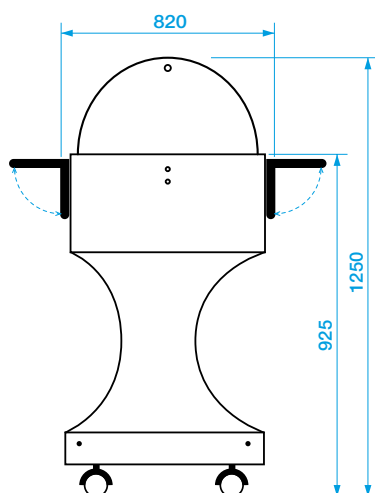

Carrelli ed espositori refrigerati - Refrigerated trolleys and display cases
Chariots et présentoirs réfrigérés - Wagen und gekühlter Ausstellungswagen



CLR 2787 (+2° +10°C) € 2.750,00

CLR 2787BT (-5° +5°C) € 3.000,00

(Gastronorm 3x1/1 - h 150)



CLR 2787W (+2° +10°C) € 2.750,00

CLR 2787BTW (-5° +5°C) € 3.000,00

(Gastronorm 3x1/1 - h 150)

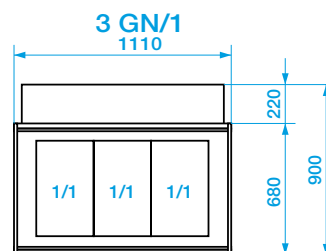
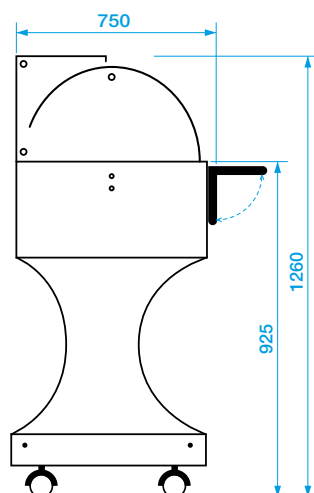

Carrelli ed espositori refrigerati - Refrigerated trolleys and display cases
Chariots et présentoirs réfrigérés - Wagen und gekühlter Ausstellungswagen



ELR 2827 (+2° +10°C) € 2.790,00

ELR 2827 BT (-5° +5°C) € 3.150,00

(Gastronorm 4x1/1 - h 150)

ELR 2827W (+2° +10°C) € 2.790,00

ELR 2827 BTW (-5° +5°C) € 3.150,00

(Gastronorm 4x1/1 - h 150)

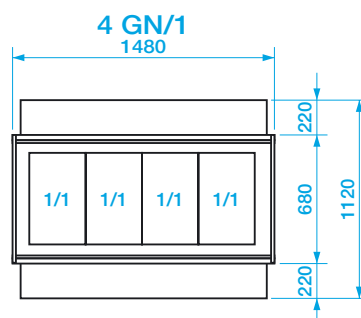
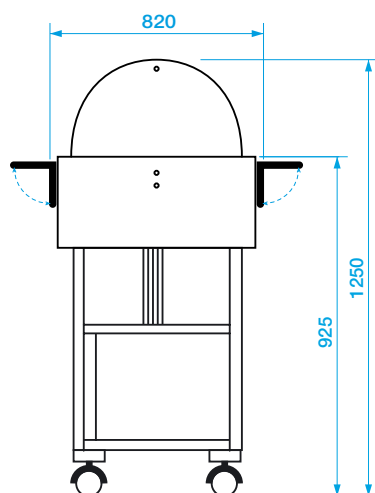

Carrelli ed espositori refrigerati - Refrigerated trolleys and display cases
Chariots et présentoirs réfrigérés - Wagen und gekühlter Ausstellungswagen



ELR 2826 (+2° +10°C) €2.790,00

ELR 2826 BT (-5° +5°C) €3.150,00

(Gastronorm 4x1/1 - h 150)

ELR 2826W (+2° +10°C) €2.790,00

ELR 2826 BTW (-5° +5°C) €3.150,00

(Gastronorm 4x1/1 - h 150)

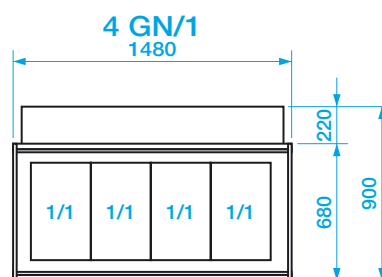
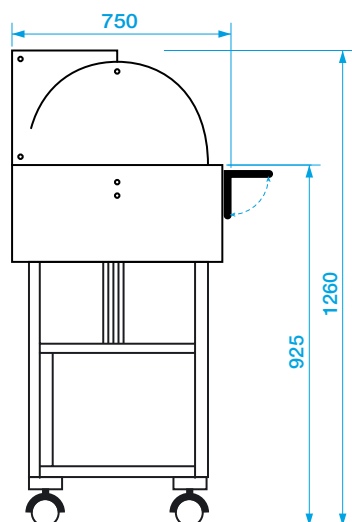

Carrelli ed espositori refrigerati - Refrigerated trolleys and display cases

Chariots et présentoirs réfrigérés - Wagen und gekühlter Ausstellungswagen

ESPOSITORE REFRIGERATO. Struttura in legno massello. Cupola in plexiglass. Refrigerazione statica. Temperatura da +2° +10°C con coperchi posizionati. Voltaggio 230 V 50 Hz 250W. Gas refrigerante: R 134 A. Dotato di 2 mensole d'appoggio pieghevoli. Capacità n. 4 gastronorm 1/1 h 150 (bacinelle escluse).

REFRIGERATED DISPLAY CASE. Solid wood frame. Plexiglass cover. Static refrigeration. Temperature between +2° +10°C when covers are positioned. 230 V 50 Hz 250W. Refrigerant: R134A. Equipped with 2 folding shelves. Capacity: 4 GN 1/1 H. 150 (containers not included).

PRESENTOIR RÉFRIGÉRÉ. Structure en bois massif. Convercle en plexiglass. Réfrigération statique. Température de +2° +10°C avec les couvercles en position. Voltage 230V 50 Hz 250W. Gaz réfrigérant: R134 A. Equipé de 2 étagères pliables. Capacité 4 GN 1/1 h 150 (bacs exclus).

GEKÜHLTER AUSSTELLUNGSWAGEN. Aufbau aus massivem Holz. Abdeckung aus Plexiglas. Statische Kühlung. Temperatur von 2°C bis 10°C (bei geschlossener Abdeckung). Versorgungsspannung 230 V, 50 Hz 250W. Kühlgas: R134A. Ausstattung mit 2 KlappbarerStützkonsolen klappbar. Kapazität 4 GN 1/1 h 150 (Schüsseln Ausgenommen).



ELR 2825 (+2° +10°C) € 2.920,00

ELR 2825W (+2° +10°C) € 2.920,00

ELR 2825 BT (-5° +5°C) € 3.270,00

ELR 2825BTW (-5° +5°C) € 3.270,00

(Gastronorm 4x1/1 - h 150)

(Gastronorm 4x1/1 - h 150)

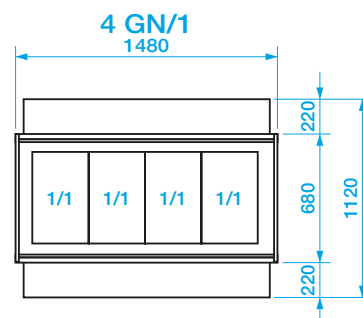
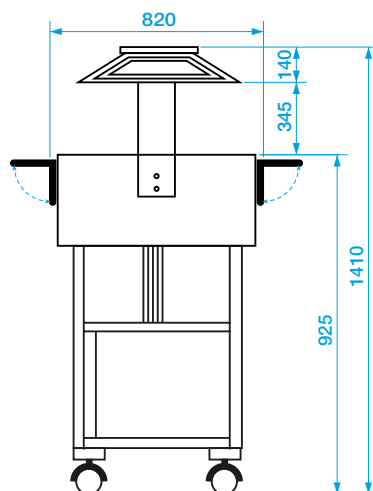



Carrelli ed espositori refrigerati - Refrigerated trolleys and display cases Chariots et présentoirs réfrigérés - Wagen und gekühlter Ausstellungswagen

 **CARRELLO REFRIGERATO A PIASTRE EUTETTICHE.** Struttura portante in legno multistrato di betulla tinto noce con cupola in plx con vasca e griglia in acciaio inox. N° 8 piastre eutettiche. Adatto per dolci, formaggi, salumi e antipasti. Può contenere n° 5 bacinelle gastronom 1/4 65 h e n° 5 1/6 65 h. Portata complessiva kg 50.

 **EUTECTIC PLATE REFRIGERATED TROLLEY.** Multilayer birchwood walnut colour frame with plexiglass cover, stainless steel basin and grill, 8 eutectic plates. Suitable for desserts, cheese, sausages and hors d'oeuvres. It can hold 5 GN 1/4 H. 65 and n° 5 1/6 65 H. Total capacity 50 Kg.



 **CHARIOT RÉFRIGÉRÉ À PLAQUES EUTECTIQUES.** Structure porteuse en bois feuilleté de bouleau couleur noyer avec couvercle en plexiglass. Cuve et grille en acier inox. 8 plaques eutectiques. Indiqués pour la pâtisserie, les fromages, la charcuterie et les hors-d'oeuvres. Peut contenir 5 bacs gn 1/4 h 65 et n° 5 1/6 65 h. Portée totale 50 Kg.

 **KÜHLWAGEN MIT EUTEKTISCHEN PLATTEN.** Tragende Struktur aus vielschichtigem Birkenholz Nussbaum Farbe mit Abdeckkuppel aus Plexiglas. Wanne und Rost aus Inox-Stahl. 8 eutektische Platten, geeignet für Süßspeisen, Käse, Wurst und Vorspeisen. Kann 5 GN 1/4 h 65 und 5 1/6 65 h. Schüsseln aufnehmen. Tragfähigkeit 50 Kg.



CL 2785

€ 1.390,00

CL 2785W

€ 1.390,00

DIMENSIONI ESTERNE LxPxH cm
EXTERNAL DIMENSIONS LxPxH cm
DIMENSIONS EXTERIEURES LxPxH cm
AUBENABMESSUNGEN LxPxH cm

106x55x108 h

 **CARRELLO REFRIGERATO IN LEGNO CON CUPOLA IN PLEXIGLASS.** Struttura in legno massello. Cupola in plexiglass. Refrigerazione statica. Temperatura da +2° +10°C (a cupola chiusa). Voltaggio 230 V 50 Hz 250W. Gas refrigerante: R 134 A. Capacità n. 3 gastronom 1/1 h 150. Dotato di 2 mensole d'appoggio pieghevoli (bacinelle escluse).

 **REFRIGERATED WOODEN TROLLEY WITH PLEXIGLASS.** Solid wood frame, Plexiglas cover. Static refrigeration. Temperature between +2° +10°C with dome closed. 230 V 50 Hz 250W. Refrigerant: R134A. Capacity: 3 GN 1/1 H. 150. Equipped with two folding shelves. Structure en bois massif, cloche en plexiglas (containers not included).



 **CHARIOT RÉFRIGÉRÉ EN BOIS AVEC CONVERCLE EN PLEXIGLASS.** Réfrigération statique. Température de +2° +10°C (cloche fermée). Voltage 230V 50 Hz 250W. Gaz réfrigérant: R134 A. Capacité 3 GN 1/1 h 150. Doté de 2 étagères pliable (bacs exclus).

 **KÜHLWAGEN AUS MASSIVEM HOLZ MIT PLEXIGLAS-ABDECKUNG.** Aufbau aus massivem Holz, Abdeckung aus Plexiglas. Statische Kühlung. Temperatur von 2 bis 10°C (bei geschlossener Abdeckung). Versorgungsspannung 230 V, 50 Hz 250W. Kühlgas: R134A. Kapazität 3 GN 1/1 h 150. Mit 2 Klappbar stützkonsole (Schüsseln Ausgenommen).

CLR 2782 (+2° +10°C)

€ 2.900,00

CLR 2782W (+2° +10°C)

€ 2.900,00

DIMENSIONI ESTERNE LxPxH cm
EXTERNAL DIMENSIONS LxPxH cm
DIMENSIONS EXTERIEURES LxPxH cm
AUBENABMESSUNGEN LxPxH cm

111x82x134 h
GN 3x1/1 150 h

Optionals

CLR311

Vasca inox forata GN 3x1/1-H 100
Stainless steel perforated container
Bac inox perforée
Behälter aus rostfreiem Stahl mit Löcher

€ 130,00

Carrelli ed espositori refrigerati - Refrigerated trolleys and display cases

Chariots et présentoirs réfrigérés - Wagen und gekühlter Ausstellungswagen

CARRELLO REFRIGERATO IN LEGNO CON CUPOLA IN PLEXIGLASS. CON LUCE AL NEON. Struttura in legno massello. Cupola in plexiglass. Refrigerazione statica Temperatura da +2° +10°C con coperchi posizionati. Voltaggio 230 V 50 Hz. Gas refrigerante: R 134 A. Capacità n. 3 gastronorm 1/1 h 150. Dotato di 2 mensole d'appoggio pieghevoli (bacinelle escluse).

WOODEN REFRIGERATED CARTS WITH PLEXIGLAS DOMES AND NEON LIGHT. Solid wood frame. Plexiglass cover. Static refrigeration. Temperature between +2° +10°C when covers are positioned. 230 V 50 Hz. Refrigerant: R134A. Capacity: 3 GN 1/1 H. 150. Equipped with two folding shelves (containers not included).



CHARIOT RÉFRIGÉRÉ EN BOIS AVEC CLOCHE EN PLEXIGLASS ET LAMPE NEON. Structure en bois massif, couvercle en plexiglass. Réfrigération statique. Température de +2° +10°C avec les couvercles en position. Voltage 230V 50 Hz. Gaz réfrigérant: R134 A. Capacité 3 GN 1/1 h 150. Equipé de 2 étagères pliables (bacs exclus).

KÜHLWAGEN AUS MASSIVEM HOLZ MIT PLEXIGLAS-ABDECKUNG. MIT NEONLICHT. Aufbau aus massivem Holz, Abdeckung aus Plexiglas. Statische Kühlung. Temperatur von 2°C bis 10°C (bei geschlossener Abdeckung). Versorgungsspannung 230 V, 50 Hz. Kühlgas: R134A. Kapazität 3 GN 1/1 h 150. Kapazität 3 GN 1/1 h 150. Mit 2 Klappbaren Stützkonsolen ausgestattet (Schüsseln Ausgenommen).

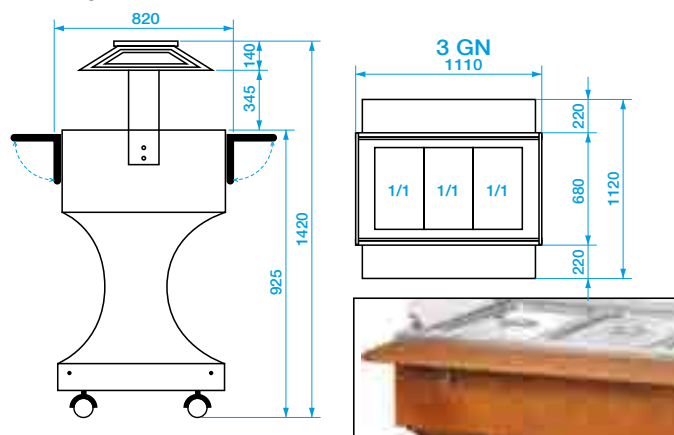

CLR 2786 (+2° +10°C)

€ 2.800,00

CLR 2786W (+2° +10°C)

€ 2.800,00

Gastronorm 3x1/1 150 h

CARRELLO REFRIGERATO IN LEGNO. Struttura in legno massello. Refrigerazione statica. Temperatura da +2° +10°C con coperchi posizionati. Voltaggio 230 V 50 Hz. Gas refrigerante: R 134 A. Capacità n. 3 gastronorm 1/1 h 150. Dotato di 1 mensola d'appoggio pieghevole (bacinelle escluse).

WOODEN REFRIGERATED TROLLEY. Solid wood frame. Static refrigeration. Temperature between +2° +10°C when covers are positioned. Refrigerant: R134A. Capacity: 3 GN 1/1 H. 150. Equipped with one folding shelf (containers not included).



CHARIOT RÉFRIGÉRÉ EN BOIS. Structure en bois massif. Réfrigération statique. Température de +2° +10°C avec les couvercles en position. Voltage 230V 50 Hz. Gaz réfrigérant: R134 A. Capacité 3 GN 1/1 h 150. Equipé de 1 étagère pliable (bacs exclus).

KÜHLWAGEN AUS MASSIVEM HOLZ. Aufbau aus massivem Holz. Statische Kühlung. Temperatur von 2°C bis 10°C (bei geschlossener Abdeckung). Versorgungsspannung 230 V, 50 Hz. Kühlgas: R134A. Kapazität 3 GN 1/1 h 150. Kapazität 3 GN 1/1 h 150. Mit 1 klappbarer Stützkonsole ausgestattet (Schüsseln Ausgenommen).

CLR 2784 (+2° +10°C)

€ 2.700,00

DIMENSIONI ESTERNE LxPxH cm
EXTERNAL DIMENSIONS LxPxH cm
DIMENSIONS EXTERIEURES LxPxH cm
AUBENABMESSUNGEN LxPxH cm

110x75x134 h
Gastronorm 3x1/1 150 h

Optionals

CLR311

Vasca inox forata GN 3x1/1-H 100
Stainless steel perforated container
Bac inox perforée
Behälter aus rostfreiem Stahl mit Löcher

€ 130,00

Espositore caldo bagnomaria con cupola - Bain-marie warmed display case with dome
Présentoir chauffé bain-marie avec cloche - Warme wasserbadausstellung mit kuppel

 **ESPOSITORE CALDO BAGNOMARIA.** Struttura in legno massello. Cupola in plexiglass. Temperatura da +30° +90°C. Voltaggio 230 V 50 Hz. Riscaldato mediante resistenza elettrica W 2000. Dotato di 2 mensole d'appoggio pieghevoli. Capacità n. 3 gastronorm 1/1 h 150 (bacinelle escluse).

 **HOT DISPLAY CASE BAIN MARIE.** Solid wood frame. Plexiglass cover. Temperature between +30° +90°C. 230 V 50 Hz. Resistance heating W 2000. Equipped with 2 folding shelves. Capacity: 3 GN 1/1 H. 150 (containers not included).

 **PRESENTOIR CHAUD BAIN-MARIE.** Structure en bois massif. Convercle en plexiglass. Température de +30° +90°C. Voltage 230V 50 Hz. Chauffage à résistance électrique W 2000. Equipé de 2 étagères pliables. Capacité 3 GN 1/1 h 150 (bacs exclus).

 **WÄRME AUSTELLUNGWAGEN WASSERBÄDER.** Aufbau aus massivem Holz. Abdeckung aus Plexiglas. Temperatur von +30° bis +90°C. Versorgungsspannung 230 V, 50 Hz. Erwärmtn durch elektrischen Widerstand W 2000. Ausstattung mit 2 Klappbarer Stützkonsolen. Kapazität: 3 GN 1/1 h 150 (Schüsseln Ausgenommen).



CL2777

€ 1.900,00

(Gastronorm 3x1/1 - h 150)

CL2777W

€ 1.900,00

(Gastronorm 3x1/1 - h 150)

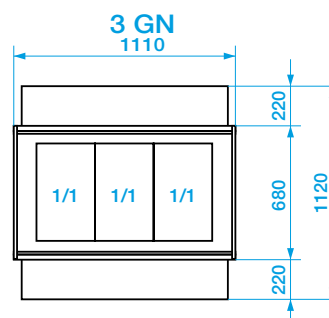
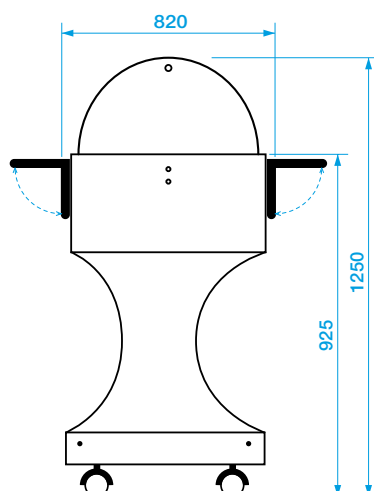

Espositore caldo bagnomaria con cupola - Bain-marie warmed display case with dome
Présentoir chauffé bain-marie avec cloche - Warme wasserbadausstellung mit kuppel



CL 2778

€ 1.900,00

(Gastronorm 3x1/1 - h 150)

CL 2778W

€ 1.900,00

(Gastronorm 3x1/1 - h 150)

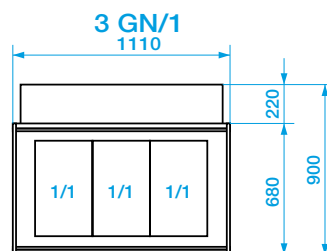
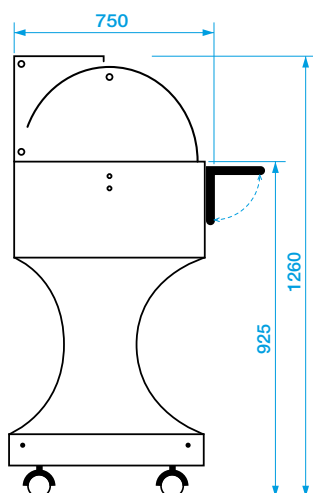

Espositore caldo bagnomaria con cupola - Bain-marie warmed display case with dome
Présentoir chauffé bain-marie avec cloche - Warme wasserbadausstellung mit kuppel



ELC 2832

€ 2.000,00

(Gastronorm 4x1/1 - h 150)

ELC 2832W

€ 2.000,00

(Gastronorm 4x1/1 - h 150)

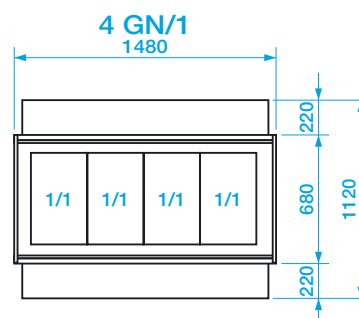
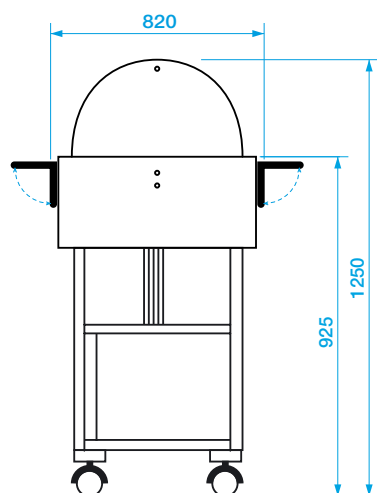

Espositore caldo bagnomaria con cupola - Bain-marie warmed display case with dome
Présentoir chauffé bain-marie avec cloche - Warme wasserbadausstellung mit kuppel



ELC 2834

€ 2.000,00

(Gastronorm 4x1/1 - h 150)

ELC 2834W

€ 2.000,00

(Gastronorm 4x1/1 - h 150)

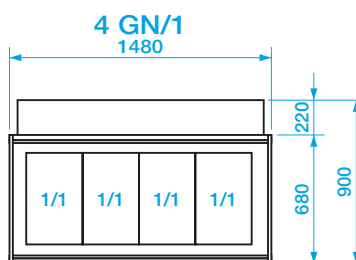
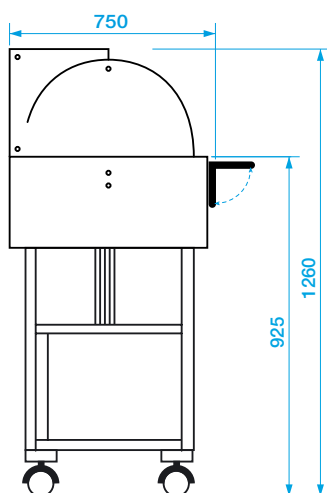

Espositore caldo bagnomaria con cupola - Bain-marie warmed display case with dome
Présentoir chauffé bain-marie avec cloche - Warme wasserbadausstellung mit kuppel

ESPOSITORE CALDO BAGNOMARIA. Struttura in legno massello. Cupola in plexiglass. Con luce al neon Temperatura da +30° +90°C. Voltaggio 230 V 50 Hz. Riscaldato mediante resistenza elettrica W 2000. Dotato di 2 mensole d'appoggio pieghevoli. Capacità n. 4 gastronorm 1/1 h 150 (bacinelle escluse).

HOT DISPLAY CASE BAIN MARIE. Solid wood frame. Plexiglass cover. Neon light. Temperature between +30° +90°C. 230 V 50 Hz. Resistance heating W 2000. Equipped with 2 folding shelves. Capacity: 4 GN 1/1 H. 150 (containers not included).

PRESENTOIR CHAUD BAIN-MARIE. Structure en bois massif. Couverture en plexiglass. Eclairage neon. Température de +30° +90°C. Voltage 230V 50 Hz. Chauffage à résistance électrique W 2000. Equipé de 2 étagères pliables. Capacité 4 GN 1/1 h 150 (bacs exclus).

WÄRME AUSTELLUNGSWAGEN WASSERBÄDER. Aufbau aus massivem Holz. Abdeckung aus Plexiglas. Neonlicht. Temperatur von +30° bis +90°C. Versorgungsspannung 230 V, 50 Hz. Erwärmt durch elektrischen Widerstand W 2000. Ausstattung mit 2 Klappbarer Stützkonsolen. Kapazität: 4 GN 1/1 h 150 (Schüsseln Ausgenommen).



ELC 2828

€ 2.140,00

Gastronorm 4x1/1 - h 150



ELC 2828W

€ 2.140,00

Gastronorm 4x1/1 - h 150

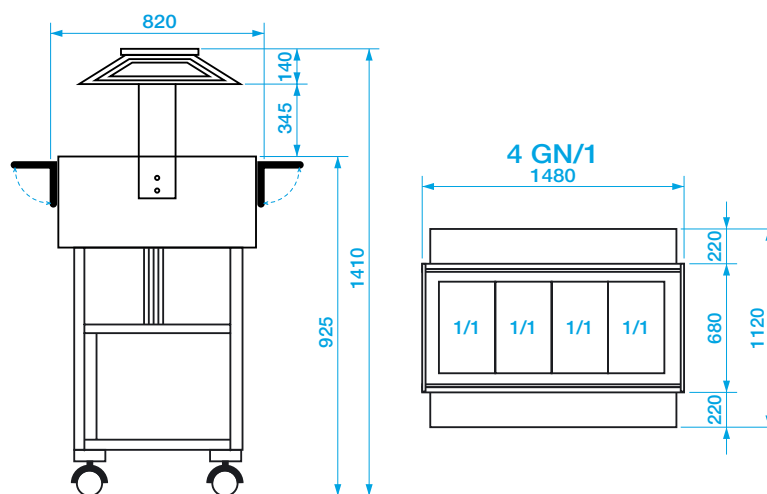

Optionals

CF411

Vasca inox forata 4X 1/1-H 100 - Stainless steel perforated container - Bac inox perforée - Behälter aus rostfreiem Stahl mit löcher

€ 150,00

Bolliti e arrosti - Roast and boiled meat trolley

Chariot pour bouillis et rotis - Wagen für Kochfleisch und Braten

 Struttura portante in legno multistrato di betulla tinto noce monocolpo. Vasca in acciaio inox per contenitori gastronorm munita di scarico. Riscaldamento mediante resistenza elettrica W 2000 230V 50/60 Hz (bacinelle escluse).

 Multilayer birchwood walnut colour monobloc frame. Stainless steel basin for gastronorm containers with drain pipe. Resistance heating W 2000 230V 50/60 Hz (containers not included).

 Chassis monobloc en bois feuilleté de bouleau couleur noyer. Bac en acier inoxydable pour cuvettes gastronorm, équipés d'égout. Chauffage à résistance électrique W 2000 230V 50/60 Hz (bacs exclus).



 Traggestell aus Vielschichtem Birkeholz Nussbaum Farbe von einem Block. Schal aus rostfreiem Stahl für Gastronorm. Behälter, mit Abfluß. Erwärmt durch elektrischen Widerstand W 2000 230V 50/60 Hz (Schüsseln Ausgenommen).

CL 2760 € 1.290,00

CL 2760W € 1.290,00

DIMENSIONI ESTERNE LxPxH cm
EXTERNAL DIMENSIONS LxPxH cm
DIMENSIONS EXTERIEURES LxPxH cm
AUBENABMESSUNGEN LxPxH cm

89x65x95 h
GN 2x1/1 - h 150

CL 2770 € 1.480,00

CL 2770W € 1.480,00

DIMENSIONI ESTERNE LxPxH cm
EXTERNAL DIMENSIONS LxPxH cm
DIMENSIONS EXTERIEURES LxPxH cm
AUBENABMESSUNGEN LxPxH cm

123x65x95 h
GN 3x1/1 - h 150

Optionals

A 580 Portacoperchi inox
Stainless steel lid-holder
Porte-couvercles en acier inoxydable
Deckelhalter aus Edelstahl € 95,00

A 590 Portacoltelli - Knives-holder
Porte-couteaux - Messerhalter € 55,00

A 600 Scorrevole portapiatti con tagliere polietilene
Sliding plate-holder with polyethylene chopping-board
Porte-plat coulissant. Plaque polyéthylène
Tellerhalter mit Hackbrett aus Polyäthylen € 120,00

 Carrello termico bagnomaria in legno per buffet. Buffet caldo cap. 3x1/1 h. 150 GN (bacinelle escluse).

 Thermal bain-marie wooded trolley for barquets.

 Chariot thermique bain-marie en bois pour banquetts.

 Thermowagen Bain-Marie für Büffet.

CL 2774 € 1.990,00

CL 2774W € 1.990,00

Optionals

C N. 4 ruote con cuffia ottonata - 4 wheels with beassy covers
4 roues avec couverture cuivrée
4 Räder mit Vermessinger Kappen € 130,00

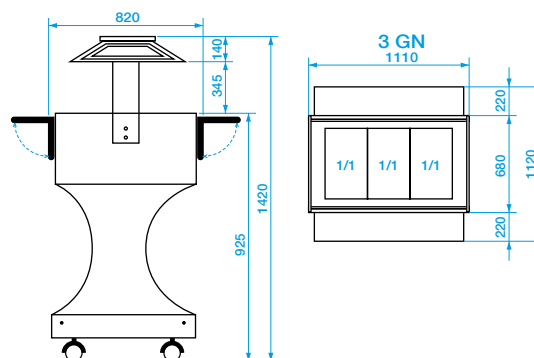

Espositore caldo bagnomaria con cupola - Bain-marie warmed display case with dome
Présentoir chauffé bain-marie avec cloche - Warme wasserbadausstellung mit kuppel

- 🇮🇹 ESPOSITORE IN LEGNO NEUTRO. Struttura in legno massello. Cupola in plexiglas. Piano inox. Dotato di 2 mensola d'appoggio pieghevoli.
- 🇬🇧 Neutral wooden display case. Solid wood frame. Plexiglas cover. Stainless steel surface. Equipped with two folding shelves.

- 🇫🇷 Présentoir en bois neutre. Structure en bois massif. Couvercle en Plexiglas. Dessus en acier inox. Equipé de deux étagères pliables.
- 🇩🇪 Neutraler Holzausstellungswagen. Aufbau aus massivem Holz. Abdeckung aus Plexiglas. Fläche aus rostfreier Stahl. Mit zwei klappbaren Stützkonsolen ausgerüstet.



ELN 2835 € 1.640,00

ELN 2835W € 1.640,00

DIMENSIONI ESTERNE LxPxH cm
 EXTERNAL DIMENSIONS LxPxH cm
 DIMENSIONS EXTERIEURES LxPxH cm
 AUBENABMESSUNGEN LxPxH cm

147x82x141 h





- 🇮🇹 CARRELLO TERMICO BAGNOMARIA IN LEGNO PER BUFFET. Buffet caldo cap. 3 x 1/1 h. 150 GN (bacinelle escluse).
- 🇬🇧 Thermal bain-marie wooden trolley for banquets.
- 🇫🇷 Chariot thermique bain-marie en bois pour banquets.
- 🇩🇪 Thermowagen Bain-Marie für Büffet.



CL2772 € 1.800,00

DIMENSIONI ESTERNE LxPxH cm
 EXTERNAL DIMENSIONS LxPxH cm
 DIMENSIONS EXTERIEURES LxPxH cm
 AUBENABMESSUNGEN LxPxH cm

123x70x135 h
GN 3x1/1 - h 150

Mensole legno per unione - Connection wooden shelves Etagères en bois pour connexion - Holzregale für Verbindung

 Mensole legno per unione - Angolo legno per unione espositori.
 Connection wooden shelves - Wooden angle bracket to connect the displays.

 Etagères en bois pour connexion - Angle en bois pour union présentoirs.
 Holzregale für Verbindung - Holzkante für Ausstellerverbindung.

PER MODELLI / FOR MODEL				
CLR2782	CLR2784	CLR2786	CLR2787	CLR2788
ELR2825	ELR2826	ELR2827		
ELC2828	ELC2832	ELC284		
CL2770	CL2772	CL2774	CL2777	CL2778

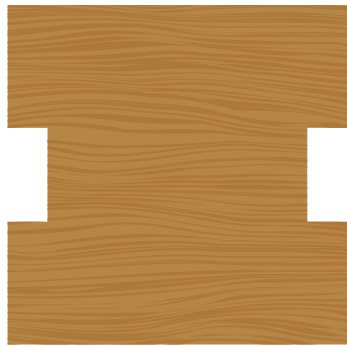

MLUN

€ 130,00

DIMENSIONI ESTERNE LxPxH cm
EXTERNAL DIMENSIONS LxPxH cm
DIMENSIONS EXTERIEURES LxPxH cm
AUBENABMESSUNGEN LxPxH cm

68x70

ANUN

€ 160,00

DIMENSIONI ESTERNE LxPxH cm
EXTERNAL DIMENSIONS LxPxH cm
DIMENSIONS EXTERIEURES LxPxH cm
AUBENABMESSUNGEN LxPxH cm

88x88

MLUNW (WENGÈ)

€ 130,00

ANUN W(WENGÈ)

€ 160,00





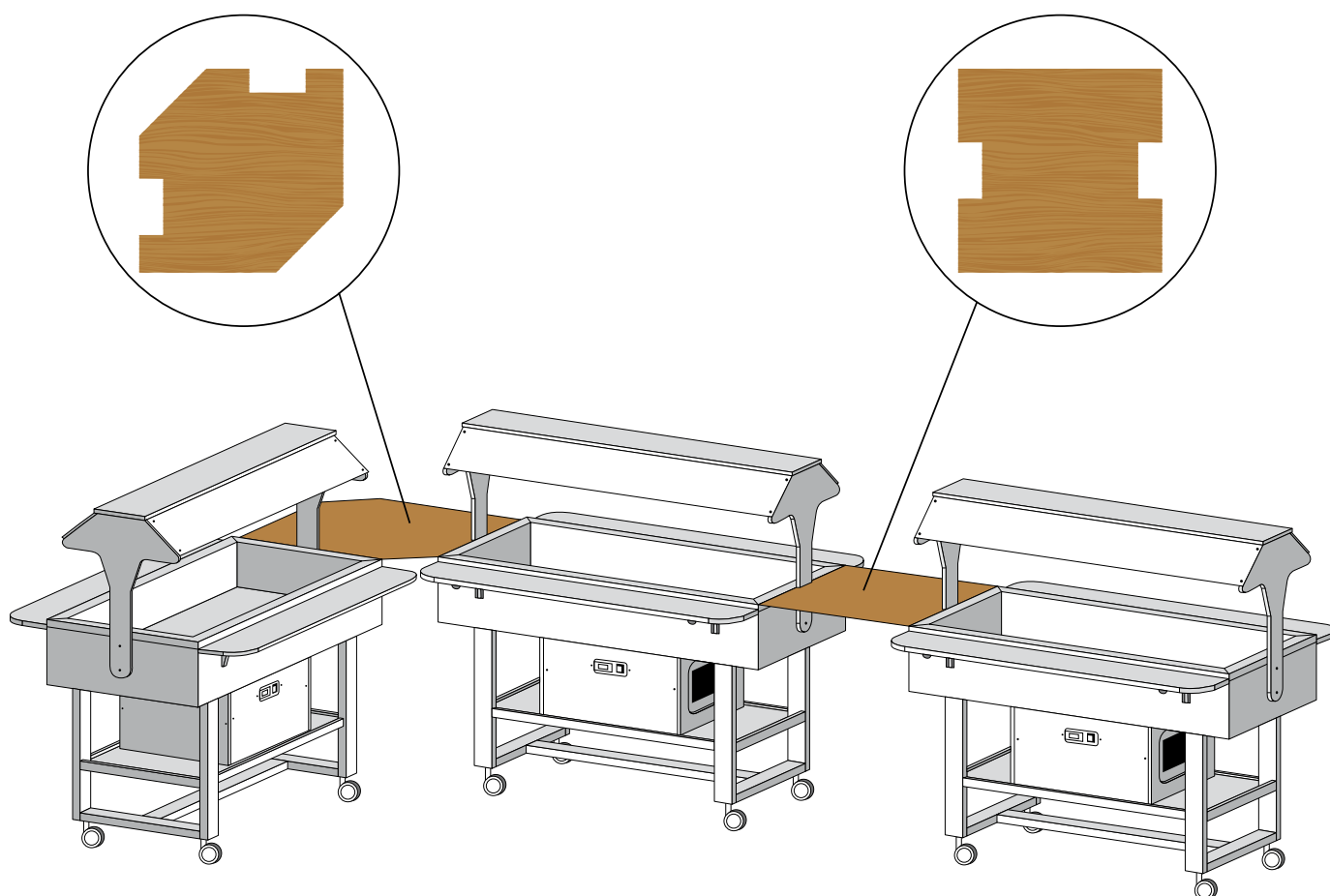
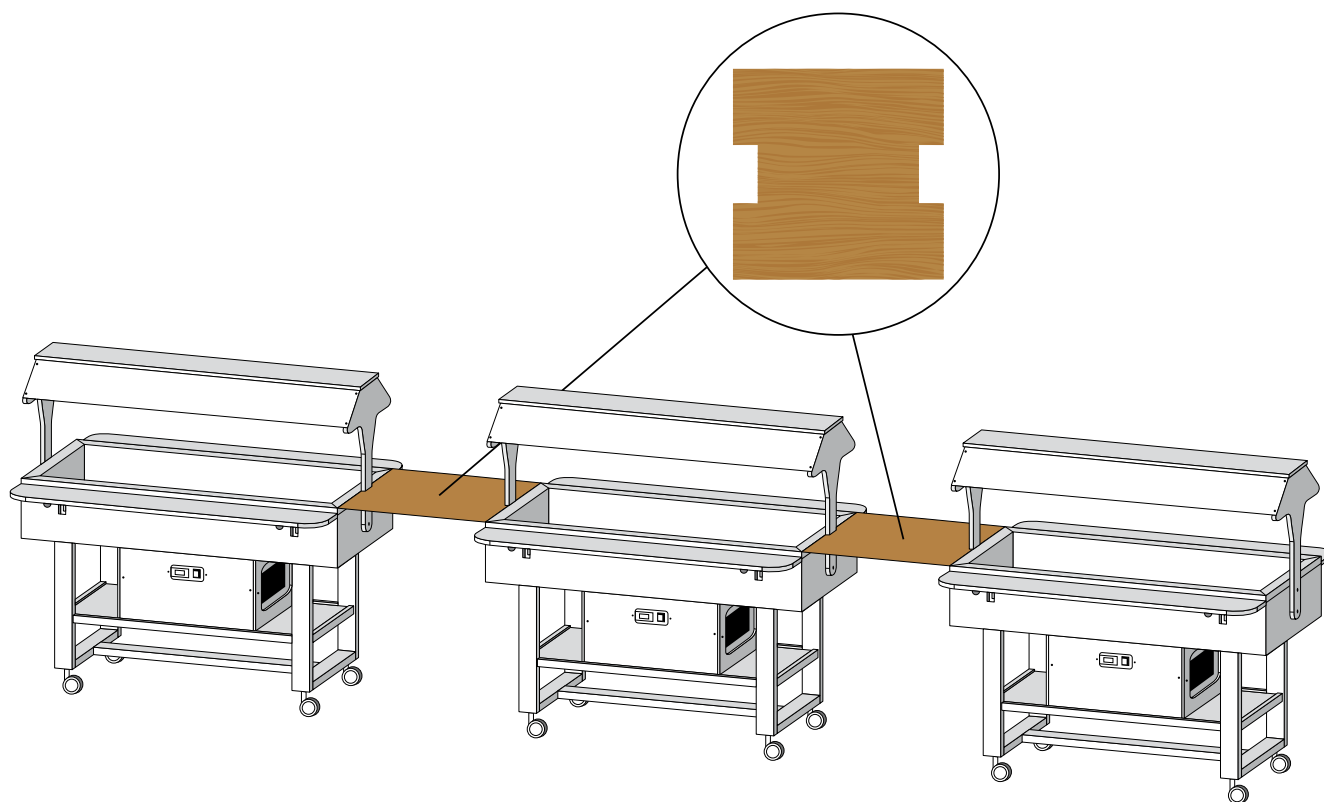

Mensole legno per unione - Connection wooden shelves
Etagères en bois pour connexion - Holzregale für Verbindung



Bolliti e arrosti - Roast and boiled meat trolley

Chariot pour bouillis et rotis - Wagen für Kochfleisch und Braten

-  **BOLLITI E ARROSTI.** Carrello per bolliti struttura portante in legno massello colore mogano cupola ovale inox lucido roll top vasca inox bagnomaria riscaldata con bruciatori ad alcool con portacoltelli e portapiatti.
-  **ROAST AND BOILED MEAT TROLLEY.** Trolley for boiled meat. Solid wood frame mahogany coloured. Oval polished s/steel roll top cover. S/steel bain-marie container heated by alcohol burners. Knife and plate-holder.
-  **CHARIOT POUR BOUILLIS ET ROTIS.** Chariot pour bouillis structure en bois massif. Couleur acajou. Couvercle oval en acier inoxydable brillant roll top. Bac en acier inoxydable bain-marie chauffée par brûleurs à alcool avec porte-couteaux et porte-plats.
-  **WAGEN FÜR KOCHFLEISCH UND BRATEN.** Wagen für Kochfleisch mit Struktur aus massiven Holz, Farbe mahagonibaumholz Ovaler Deckel aus polierten rostfreiem Stahl Roll Top, Wanne Bain-Marie aus rostfreiem Stahl mit Alkoholbrenner Geheizt. Messer- und Tellerhalter.

-  **ROAST BEEF.** Struttura portante in legno massello colore mogano. Cupola inox lucido roll top. Vasca inox bagnomaria riscaldata con piastra elettrica W 360 230V 50/60 Hz e con bruciatori ad alcool. Tagliere in polietilene. Due contenitori. Portacoltelli e portapiatti.
-  **ROAST BEEF.** Solid wood frame mahogany coloured. Polished s/steel roll top cover stainless. Steel bain-marie container with electric plate heating unit W 360 230V 50/60 Hz and with alcohol burners. Polyethylene chopping board. Two containers. Knife and plate-holder.
-  **ROAST BEEF.** Structure en bois massif, couleur acajou. Couvercle en acier inoxydable brillant roll top. Bac en acier inoxydable bain-marie chauffée par une plaque électrique W 360 230V 50/60 Hz et brûleurs à alcool. Planche à hacher en polyéthylène. Deux récipients Porte-couteaux et porte-plats.
-  **ROAST BEEF.** Struktur aus massiven Holz, Mahagoni farbe. Deckel aus polierten rostfreiem Stahl Roll top. Wanne Bain-Marie aus rostfreiem Stahl mit elektrischer Platte geheizt W 360 230V 50/60 Hz und mit Alkoholbrenner. Hackbrett aus Polyethylen. Zwei. Behälter. Messer- und Tellerhalter.



CB 8802

€ 1.250,00

DIMENSIONI ESTERNE LxPxH cm
EXTERNAL DIMENSIONS LxPxH cm
DIMENSIONS EXTERIEURES LxPxH cm
AUBENABMESSUNGEN LxPxH cm

78x63x105 h



CR 0103

€ 5.200,00

DIMENSIONI ESTERNE LxPxH cm
EXTERNAL DIMENSIONS LxPxH cm
DIMENSIONS EXTERIEURES LxPxH cm
AUBENABMESSUNGEN LxPxH cm

85x55x112 h

Tavole calde da banco



***Tavole calde da banco - bagnomaria / Tavole calde da banco con resistenza a secco
Tavola calda con pentola / Mobiletti scaldapiatti / Piani caldi inox
Piani caldi inox con piano in vetro temperato / Piani caldi con cupola in plexiglass
Con lampade a raggi infrarossi / Telaio con lampade infrarossi
Contenitore gn per condimento e mantenimento fritti***

Vetrine bar

Lunch counters



***Lunch counters - double boiler / Lunch counters with dry heating element
Lunch table double boiler with pot / Plate warming cabinets / Stainless steel warming surfaces
Stainless steel warming surfaces with surface in tempered glass
Warming surfaces with plexiglass cover / With infrared lamps / Frame with infrared lamps
Gn container for sauces and fried keeping***

Showcases for bar

Tables chauffées pour comptoir



***Tables chauffées pour comptoir - bain-marie / Tables chauffées pour comptoir avec résistance à sec
Table chauffée bain-marie avec marmite / Meubles chauffe-plats / Plateaux chauffés en inox
Plateaux chauffés en inox avec plateaux en verre tempéré
Plateaux chauffés avec couvercle en plexiglass / Avec lampes à infrarouges
Chassis avec lampes infrarouges / Cuve gn pour assaisonnement et maintien des fritures***

Vitrines pour bar

Heiztische



***Heiztische - wasserbäder / Heiztische mit trockenem thermoelement
Heiztische wasserbäder mit kochtopf / Tellerwärmemöbel / Heizplatten aus rostfreiem stahl
Heizplatten aus rostfreiem stahl mit fläche aus gehärtetem glas
Heizplatten mit deckel aus plexiglass / Mit infrarotlampen / Gestell mit infrarotlampen
Gn behälter für würzen und erhaltung des ausgebackenes***

Bar-warmvitrinen

Tavole calde da banco - Lunch counters

Tables chauffées pour comptoir - Heiztische

- 🇮🇹 TAVOLE CALDE DA BANCO - BAGNOMARIA. Struttura in acciaio inox (bacinelle escluse). Termostato regolabile 30°-90°C, V230 50/60 Hz + termostato limite salvaresistenza. Con rubinetto di scarico.
- 🇬🇧 LUNCH COUNTERS - DOUBLE BOILER. Stainless steel frame (containers not included). Adjustable thermostat 30°-90°C, V230 50/60 Hz + thermostat resistance protector. With drain tap.

- 🇫🇷 TABLES CHAUFFÉES POUR COMPTOIR - BAIN-MARIE. Structure en acier inox (cuvettes exclues). Thermostat réglable 30°-90°C, V230 50/60 Hz + thermostat limite protégé-résistance. Avec robinet d'évacuation.
- 🇩🇪 HEIZTISCHE - WASSERBÄDER. Gestell aus rostfreiem Stahl (Behälter nicht inbegriffen). Regulierbares Thermostat: 30°-90°C, V230 50/60 Hz + Schutzthermostat. Mit Auslasshahn.



BM 1780 (1x1/1 GN) € 550,00

DIMENSIONI ESTERNE - EXTERNAL DIMENSIONS LxPxH cm	49x60x32 h
DIMENSIONS EXTERIEURES - AUßENABMESSUNGEN LxPxH cm	1x1/1 GN 200 h
	2000 W

BM 1784 (3x1/1 GN) € 700,00

DIMENSIONI ESTERNE - EXTERNAL DIMENSIONS LxPxH cm	110x60x32 h
DIMENSIONS EXTERIEURES - AUßENABMESSUNGEN LxPxH cm	3x1/1 GN 200 h
	2000 W

BM 1782 (2x1/1 GN) € 620,00

DIMENSIONI ESTERNE - EXTERNAL DIMENSIONS LxPxH cm	78x60x32 h
DIMENSIONS EXTERIEURES - AUßENABMESSUNGEN LxPxH cm	2x1/1 GN 200 h
	2000 W

BM 1786 (4x1/1 GN) € 800,00

DIMENSIONI ESTERNE - EXTERNAL DIMENSIONS LxPxH cm	144x60x32 h
DIMENSIONS EXTERIEURES - AUßENABMESSUNGEN LxPxH cm	4x1/1 GN 200 h
	2000 W

- 🇮🇹 TAVOLE CALDE DA BANCO CON RESISTENZA A SECCO (senza acqua). Termostato regolabile 30°-90°C, V230 50/60 Hz.
- 🇬🇧 LUNCH COUNTERS WITH DRY HEATING ELEMENT (without water). Adjustable thermostat 30°-90°C, V230 50/60 Hz.

- 🇫🇷 TABLES CHAUFFÉES POUR COMPTOIR AVEC RÉSIDENCE À SEC (sans eau). Thermostat réglable 30°-90°C, V230 50/60 Hz.
- 🇩🇪 HEIZTISCHE MIT TROCKEM THERMOELEMENT (ohne Wasser). Regulierbares Thermostat: 30°-90°C, V230 50/60 Hz.



BMS 1781 (1x1/1 GN) € 520,00

DIMENSIONI ESTERNE - EXTERNAL DIMENSIONS LxPxH cm	49x60x32 h
DIMENSIONS EXTERIEURES - AUßENABMESSUNGEN LxPxH cm	1x1/1 GN 200 h
	1000 W

BMS 1783 (2x1/1 GN) € 600,00

DIMENSIONI ESTERNE - EXTERNAL DIMENSIONS LxPxH cm	78x60x32 h
DIMENSIONS EXTERIEURES - AUßENABMESSUNGEN LxPxH cm	2x1/1 GN 200 h
	1000 W

BMS 1785 (3x1/1 GN) € 700,00

DIMENSIONI ESTERNE - EXTERNAL DIMENSIONS LxPxH cm	110x60x32 h
DIMENSIONS EXTERIEURES - AUßENABMESSUNGEN LxPxH cm	3x1/1 GN 200 h
	2000 W

Tavole calde da banco - Lunch counters Tables chauffées pour comptoir - Heiztische

 Struttura in acciaio inox (bacinelle escluse). Termostato regolabile 30°-90°C, V230 50/60 Hz.

 Stainless steel frame (containers not included). Adjustable thermostat 30°-90°C, V230 50/60 Hz.

 Structure in acier inox (cuvettes exclues). Thermostat réglable 30°-90°C, V230 50/60 Hz.

 Gestell aus rostfreiem Stahl (Behälter nicht inbegriffen). Regulierbares Thermostat: 30°-90°C, V230 50/60 Hz.



BM 11 (1x1/1 GN)

€ 270,00

DIMENSIONI ESTERNE - EXTERNAL DIMENSIONS LxPxH cm
DIMENSIONS EXTERIEURES - AUßENABMESSUNGEN LxPxH cm

54x33x22 h
1x1/1 GN 150 h

1200 W

BM 21 (2x1/1 GN)

€ 420,00

DIMENSIONI ESTERNE - EXTERNAL DIMENSIONS LxPxH cm
DIMENSIONS EXTERIEURES - AUßENABMESSUNGEN LxPxH cm

66x54x22 h
2x1/1 GN 150 h

1200 W + 1200 W

BM 31 (3x1/1 GN)

€ 550,00

DIMENSIONI ESTERNE - EXTERNAL DIMENSIONS LxPxH cm
DIMENSIONS EXTERIEURES - AUßENABMESSUNGEN LxPxH cm

99x54x22 h
3x1/1 GN 150 h

1000 W + 1000 W + 1000 W



TEMPERATURE DIFFERENZIATE - CON RUBINETTO DI SCARICO
DIFFERENT TEMPERATURES - WITH DRAIN TAP
TEMPERATURES DIFFÉRENTES - AVEC ROBINET D'ÉVACUATION
VERSCHIEDENE TEMPERATUREN - MIT AUSLASSHAHN

BMV 11 (1x1/1 GN)

€ 310,00

DIMENSIONI ESTERNE - EXTERNAL DIMENSIONS LxPxH cm
DIMENSIONS EXTERIEURES - AUßENABMESSUNGEN LxPxH cm

54x33x22 h
1x1/1 GN 150 h

1200 W

BMV 21 (2x1/1 GN)

€ 480,00

DIMENSIONI ESTERNE - EXTERNAL DIMENSIONS LxPxH cm
DIMENSIONS EXTERIEURES - AUßENABMESSUNGEN LxPxH cm

66x54x22 h
2x1/1 GN 150 h

1200 W + 1200 W

BMV 31 (3x1/1 GN)

€ 650,00

DIMENSIONI ESTERNE - EXTERNAL DIMENSIONS LxPxH cm
DIMENSIONS EXTERIEURES - AUßENABMESSUNGEN LxPxH cm

99x54x22 h
3x1/1 GN 150 h

1000 W + 1000 W + 1000 W

Tavole calde da banco - Lunch counters Tables chauffées pour comptoir - Heiztische

 TAVOLA CALDA. Tavola calda bagnomaria acciaio inox Cap. 1/1 H 150 GN W 1200 230 V 50/60 Hz (bacinelle escluse).

 LUNCH TABLE DOUBLE BOILER. Lunch table double boiler stainless steel. Capacity 1/1 h 150 GN W 1200 230 V 50/60 Hz (containers not included).

 TABLE CHAUFFÉE BAINMARIE. Table chauffée bain-marie acier inoxydable. Capacité 1/1 h 150 GN W 1200 230 V 50/60 Hz (bacs exclus).

 HEIZTISCHE WASSERBÄDER. Heitzisch Wasserbäder aus rostfreiem Stahl. Kapazität 1/1 h 150 GN W 1200 230 V 50/60 Hz (Schüsseln Ausgenommen).





BM 7700

€ 165,00

DIMENSIONI ESTERNE LxPxH cm
EXTERNAL DIMENSIONS LxPxH cm
DIMENSIONS EXTERIEURES LxPxH cm
AUßENABMESSUNGEN LxPxH cm

57x37x22 h

 TAVOLA CALDA CON PENTOLA. Tavola calda bagnomaria acciaio inox. Cap. 1/1 con 2 pentole Lt. 8, W 1200 230 V 50/60 Hz.

 LUNCH TABLE DOUBLE BOILER WITH POT. Lunch table double boiler stainless steel. Capacity 1/1 with 2 pots Lt. 8, W 1200 230 V 50/60 Hz.

 TABLE CHAUFFÉE BAIN-MARIE AVEC MARMITE. Table chauffée bain-marie acier inoxydable. Capacité 1/1 avec 2 marmites Lt. 8, W 1200 230 V 50/60 Hz.

 HEIZTISCHE WASSREBÄDER MIT KOCHTOPF. Heitzisch Wasserbäder aus rostfreiem Stahl. Kapazität 1/1 mit 2 kochtöpfe Lt. 8, W 1200 230 V 50/60 Hz.



BMP 7720

€ 240,00

DIMENSIONI ESTERNE LxPxH cm
EXTERNAL DIMENSIONS LxPxH cm
DIMENSIONS EXTERIEURES LxPxH cm
AUßENABMESSUNGEN LxPxH cm

57x37x28 h

Piani caldi inox - Stainless steel warming surfaces Plateaux chauffés en inox - Heizplatten aus rostfreiem stahl

PIANI CALDI INOX. Struttura in acciaio inox. Termostato regolabile 30°-90°C, V 230 50/60 Hz.

PLATEAUX CHAUFFÉS EN INOX. Structure in acier inox. Thermostat réglable 30°-90°C, V 230 50/60 Hz.

STAINLESS STEEL WARMING SURFACES. Stainless steel frame. Adjustable thermostat 30°-90°C, V 230 50/60 Hz.

HEIZPLATTEN AUS ROSTFREIEM STAHL. Gestell aus rostfreiem Stahl. Regulierbares Thermostat: 30°-90°C, V 230 50/60 Hz.



PC 4750	€ 165,00
DIMENSIONI ESTERNE LxPxH cm EXTERNAL DIMENSIONS LxPxH cm DIMENSIONS EXTERIEURES LxPxH cm AUBENABMESSUNGEN LxPxH cm	50x35x6 h
	250 W

PC 4752	€ 205,00
DIMENSIONI ESTERNE LxPxH cm EXTERNAL DIMENSIONS LxPxH cm DIMENSIONS EXTERIEURES LxPxH cm AUBENABMESSUNGEN LxPxH cm	90x45x6 h
	450 W

PC 4754	€ 250,00
DIMENSIONI ESTERNE LxPxH cm EXTERNAL DIMENSIONS LxPxH cm DIMENSIONS EXTERIEURES LxPxH cm AUBENABMESSUNGEN LxPxH cm	100x50x6 h
	600 W

PC 5050	€ 205,00
DIMENSIONI ESTERNE LxPxH cm EXTERNAL DIMENSIONS LxPxH cm DIMENSIONS EXTERIEURES LxPxH cm AUBENABMESSUNGEN LxPxH cm	50x50x6 h
	600 W

PC 6040	€ 205,00
DIMENSIONI ESTERNE LxPxH cm EXTERNAL DIMENSIONS LxPxH cm DIMENSIONS EXTERIEURES LxPxH cm AUBENABMESSUNGEN LxPxH cm	60x40x6 h
	600 W

PC 8060	€ 260,00
DIMENSIONI ESTERNE LxPxH cm EXTERNAL DIMENSIONS LxPxH cm DIMENSIONS EXTERIEURES LxPxH cm AUBENABMESSUNGEN LxPxH cm	80x60x6 h
	1000 W

PIANI CALDI INOX CON PIANO IN VETRO TEMPERATO. Struttura in acciaio inox. Termostato regolabile 30°-90°C, V 230 50/60 Hz.

PLATEAUX CHAUFFÉS EN INOX AVEC PLATEAUX EN VERRE TEMPÉRÉ. Structure in acier inox. Thermostat réglable 30°-90°C, V 230 50/60 Hz.

STAINLESS STEEL WARMING SURFACES WITH SURFACE IN TEMPERATED GLASS. Stainless steel frame. Adjustable thermostat 30°-90°C, V 230 50/60 Hz.

HEIZPLATTEN AUS ROSTFREIEM STAHL MIT FLÄCHE AUS GEHÄRTETEM GLAS. Gestell aus rostfreiem Stahl. Regulierbares Thermostat: 30°-90°C, V 230 50/60 Hz.



PVC 4760	€ 215,00
DIMENSIONI ESTERNE LxPxH cm EXTERNAL DIMENSIONS LxPxH cm DIMENSIONS EXTERIEURES LxPxH cm AUBENABMESSUNGEN LxPxH cm	50x50x7 h
	600 W

PVC 4763	€ 210,00
DIMENSIONI ESTERNE LxPxH cm EXTERNAL DIMENSIONS LxPxH cm DIMENSIONS EXTERIEURES LxPxH cm AUBENABMESSUNGEN LxPxH cm	60x40x7 h
	600 W

PVC 4765	€ 290,00
DIMENSIONI ESTERNE LxPxH cm EXTERNAL DIMENSIONS LxPxH cm DIMENSIONS EXTERIEURES LxPxH cm AUBENABMESSUNGEN LxPxH cm	81x61x7 h
	1000 W

Piani caldi con cupola in plexiglass - Warming surfaces with plexiglass cover
Plateaux chauffés avec couvercle en plexiglass - Heizplatten mit deckel aus plexiglass

 **PIANI CALDI CON CUPOLA IN PLEXIGLASS.** Struttura in acciaio inox. Termostato regolabile 30°-90°C, V 220, W 450.

 **WARMING SURFACES WITH PLEXIGLASS COVER.** Stainless steel frame. Adjustable thermostat 30°-90°C, V 220, W 450.

 **PLATEAUX CHEUFFÉS AVEC COUVERCLE EN PLEXIGLASS.** Structure in acier inox. Thermostat réglable 30°-90°C, V 220, W 450.

 **HEIZPLATTEN MIT DECKEL AUS PLEXIGLASS.** Gestell aus rostfreiem Stahl. Regulierbares Thermostat: 30°-90°C, V 220, W 450.



PCC 4710

€ 425,00

DIMENSIONI ESTERNE LxPxH cm
 EXTERNAL DIMENSIONS LxPxH cm
 DIMENSIONS EXTERIEURES LxPxH cm
 AUBENABMESSUNGEN LxPxH cm

90x45x20 h

450 W

 **PIANI CALDI CON CUPOLA IN PLEXIGLASS.** Cupola in plexiglass semicilindrica a due aperture.

 **WARMING SURFACES WITH PLEXIGLASS COVER.** Semicircular plexiglass cover with two openings.

 **PLATEAUX CHEUFFÉS AVEC COUVERCLE EN PLEXIGLASS.** Couvercle en plexiglass semi-cylindrique à deux ouvertures.

 **HEIZPLATTEN MIT DECKEL AUS PLEXIGLASS.** Halbzyllindrischer Deckel aus Plexiglas mit zwei Öffnungen.



PCC 4730

€ 435,00

DIMENSIONI ESTERNE LxPxH cm
 EXTERNAL DIMENSIONS LxPxH cm
 DIMENSIONS EXTERIEURES LxPxH cm
 AUBENABMESSUNGEN LxPxH cm

100x50x30 h

600 W

Piani caldi inox con lampade a raggi infrarossi - Stainless steel warming surfaces with infrared lamps
Plateaux chauffés en inox avec lampes à infrarouges - Heizplatten aus rostfreiem stahl mit infrarotlampen

 CON LAMPADE A RAGGI INFRAROSSI. Struttura in acciaio inox. Termostato regolabile 30°-90°C, V 230 50/60 Hz. Copertura in polycarbonato fumé.

 WITH INFRARED LAMPS. Stainless steel frame. Adjustable thermostat 30°-90°C, V 230 50/60 Hz. Polycarbonate cover grey colour.

 AVEC LAMPES À INFRAROUGES. Structure in acier inox. Thermostat réglable 30°-90°C, V 230 50/60 Hz. Couverture en polycarbonate gris.



 TELAIO CON LAMPADE INFRAROSSI.

 FRAME WITH INFRARED LAMPS.

 CHASSIS AVEC LAMPES INFRAROUGES.

 GESTELL MIT INFRAROTLAMPEN.



 TELAIO CON LAMPADE INFRAROSSI DA APPENDERE.

 STRUCTURE A MUR AVEC LAMPES A INFRAROUGES.

 FRAME WITH INFRARED LAMPS TO BE HANGED.

 GESTELL MIT INFRAROTLAMPEN UM ZU AUFHAENGEN.



 MIT INFRAROTLAMPEN. Gestell aus rostfreiem Stahl. Regulierbares Thermostat: 30°-90°C, V 230 50/60 Hz. Bedeckung aus Polycarbonat Farbe grau.

PCI 4711 € 390,00

DIMENSIONI ESTERNE - EXTERNAL DIMENSIONS LxPxH cm **45x64x80 h**
 DIMENSIONS EXTERIEURES - AUBENABMESSUNGEN LxPxH cm

1 lampada - lamp - lampe - Lampe: 250 W + 250 W

PCI 4712 € 490,00

DIMENSIONI ESTERNE - EXTERNAL DIMENSIONS LxPxH cm **85x64x80 h**
 DIMENSIONS EXTERIEURES - AUBENABMESSUNGEN LxPxH cm

2 lampade - lamps - lampes - Lampen: 450 W + 500 W

PCI 4713 € 610,00

DIMENSIONI ESTERNE - EXTERNAL DIMENSIONS LxPxH cm **127x68x80 h**
 DIMENSIONS EXTERIEURES - AUBENABMESSUNGEN LxPxH cm

3 lampade - lamps - lampes - Lampen: 600 W + 750 W

PI 4714 € 250,00

DIMENSIONI ESTERNE - EXTERNAL DIMENSIONS LxPxH cm **45x55x70 h**
 DIMENSIONS EXTERIEURES - AUBENABMESSUNGEN LxPxH cm

1 lampada - lamp - lampe - Lampe: Hz 250 W

PI 4715 € 330,00

DIMENSIONI ESTERNE - EXTERNAL DIMENSIONS LxPxH cm **85x55x70 h**
 DIMENSIONS EXTERIEURES - AUBENABMESSUNGEN LxPxH cm

2 lampade - lamps - lampes - Lampen: 500 W

PI 4716 € 410,00

DIMENSIONI ESTERNE - EXTERNAL DIMENSIONS LxPxH cm **127x55x70 h**
 DIMENSIONS EXTERIEURES - AUBENABMESSUNGEN LxPxH cm

3 lampade - lamps - lampes - Lampen: 750 W

PIA 4714 € 190,00

DIMENSIONI ESTERNE - EXTERNAL DIMENSIONS LxPxH cm **45x68x25 h**
 DIMENSIONS EXTERIEURES - AUBENABMESSUNGEN LxPxH cm

1 lampada - lamp - lampe - Lampe: 250W

PIA 4715 € 260,00

DIMENSIONI ESTERNE - EXTERNAL DIMENSIONS LxPxH cm **85x68x25 h**
 DIMENSIONS EXTERIEURES - AUBENABMESSUNGEN LxPxH cm

2 lampade - lamps - lampes - Lampen: 500W





PIA 4716 € 340,00

DIMENSIONI ESTERNE - EXTERNAL DIMENSIONS LxPxH cm **128x68x25 h**
 DIMENSIONS EXTERIEURES - AUBENABMESSUNGEN LxPxH cm

3 lampade - lamps - lampes - Lampen: 750W

Piani caldi inox con lampade a raggi infrarossi - Stainless steel warming surfaces with infrared lamps
Plateaux chauffés en inox avec lampes à infrarouges - Heizplatten aus rostfreiem stahl mit infrarotlampen



-  PIANO CALDO CON LAMPADA A RAGGI INFRAROSSI. Struttura in acciaio inox. Termostato regolabile 30°-90°C, V230 50/60 Hz, 250W+250W.
-  WARMING SURFACE WITH INFRARED LAMP. Stainless steel frame. Adjustable thermostat 30°-90°C, V230 50/60Hz, 250W+250W.
-  PLATEAU CHAUFFANT AVEC LAMPE A INFRAROUGES. Structure in acier inox. Thermostat réglable 30°-90°C, V230 50/60 Hz, 250W+250W.
-  HEIZPLATTE MIT INFRAROTLAMPE. Gestell aus rostfreiem Stahl. Regulierbares Thermostat 30°-90°C, V230 50/60 Hz, 250W+250W.





PCI 4718

€ 300,00

DIMENSIONI ESTERNE - EXTERNAL DIMENSIONS LxPxH cm
 DIMENSIONS EXTERIEURES - AUßENABMESSUNGEN LxPxH cm

58x33x68 h



-  PIANO CALDO CON 2 LAMPADE A RAGGI INFRAROSSI. Struttura in acciaio inox. Termostato regolabile 30°-90°C, V230 50/60 Hz, 250W+250W+250W.
-  WARMING SURFACE WITH 2 INFRARED LAMPS. Stainless steel frame. Adjustable thermostat 30°-90°C, V230 50/60Hz, 250W+250W+250W.
-  PLATEAU CHAUFFANT AVEC 2 LAMPES A INFRAROUGES. Structure en acier inox. Thermostat réglable 30°-90°C, V230 50/60 Hz, 250W+250W+250W.
-  HEIZPLATTE MIT 2 INFRAROTLAMPEN. Gestell aus rostfreiem Stahl. Regulierbares Thermostat 30°-90°C, V230 50/60 Hz, 250W+250W+250W.

PCI 4718 D



€ 380,00

DIMENSIONI ESTERNE - EXTERNAL DIMENSIONS LxPxH cm
 DIMENSIONS EXTERIEURES - AUßENABMESSUNGEN LxPxH cm

58x33x68 h



Piano da 60x40
 60x40 shelf
 Etage 60x40
 Platte 60x40

-  PIANO CALDO CON 2 LAMPADE A RAGGI INFRAROSSI. Struttura in acciaio inox. Termostato regolabile 30°-90°C, V230 50/60 Hz, 250W+250W+250W.
-  WARMING SURFACE WITH 2 INFRARED LAMPS. Stainless steel frame. Adjustable thermostat 30°-90°C, V230 50/60Hz, 250W+250W+250W.
-  PLATEAU CHAUFFANT AVEC 2 LAMPES A INFRAROUGES. Structure en acier inox. Thermostat réglable 30°-90°C, V230 50/60 Hz, 250W+250W+250W.
-  HEIZPLATTE MIT 2 INFRAROTLAMPEN. Gestell aus rostfreiem Stahl. Regulierbares Thermostat 30°-90°C, V230 50/60 Hz, 250W+250W+250W.

PCI 4717





€ 390,00

DIMENSIONI ESTERNE - EXTERNAL DIMENSIONS LxPxH cm
 DIMENSIONS EXTERIEURES - AUßENABMESSUNGEN LxPxH cm

60x40x68 h

Tavole calde da banco con lampade a raggi infrarossi - Lunch counters with infrared lamps
Tables chauffées pour comptoir with infrared lamps - Heitzische - wasserbäder mit infrarotlampen



-  CONTENITORE GN PER CONDIMENTO E MANTENIMENTO FRITTI. Struttura in acciaio inox. Lampada a raggi infrarossi W250 - V 230.
-  GN CONTAINER FOR SAUCES AND FRIED KEEPING. Stainless steel frame. Infrared lamp W250 - V 230 50/60 Hz.
-  CUVE GN POUR ASSAISONNEMENT ET MAINTIEN DES FRITURES. Structure in acier inox. Lampe infrarouges W250 - V 230 50/60 Hz.
-  GN BEHÄLTER FÜR WÜRZEN UND ERHALTUNG DES AUSGEBACKENES. Gestell aus rostfreiem Stahl. Infrarotlampe W250 - V 230 50/60 Hz.





BI 4719

€ 340,00

DIMENSIONI ESTERNE - EXTERNAL DIMENSIONS LxPxH cm
 DIMENSIONS EXTERIEURES - AUßENABMESSUNGEN LxPxH cm

60x33x68 h



-  CONTENITORE GN CON 2 LAMPAD E A RAGGI INFRAROSSA.
-  GN CONTAINER WITH 2 INFRARED LAMPS.
-  CUVE GN AVEC 2 LAMPES A INFRAROUGES.
-  GN BEHAELTER MIT 2 INFRAROTLAMPEN .

BI 4719 D

€ 430,00

DIMENSIONI ESTERNE - EXTERNAL DIMENSIONS LxPxH cm
 DIMENSIONS EXTERIEURES - AUßENABMESSUNGEN LxPxH cm



60x33x68 h



Optionals

A 516 Vasca riscaldata per BI 4719 - Heated container for BI 4719
 Cuve chauffée pour BI 4719 - Erwärmter Behälter für BI 4719

€ 112,00 cad./each

Mobiletti scaldapiatti - Plate warming cabinets **Meubles chauffe-plats - Tellerwärm Möbel**

-  **MOBILETTI SCALDAPIATTI.** Struttura in acciaio inox. Termostato regolabile 30°-90°C, V230 50/60 Hz. Interruttore con spia luminosa. Ruote piroettanti. 1 ripiano intermedio. Interamente coibentato.
-  **PLATE WARMING CABINETS.** Structure made of stainless steel. Adjustable thermostat 30°-90°C. Main supply V230 50/60 Hz. Switch with warning light. Multidirectional wheels. 1 insulated shelf.

-  **MEUBLES CHAUFFE-PLATS.** Structure entièrement en acier inoxydable. Thermostat réglable 30°-90°C, V230 50/60 Hz. Interrupteur d'allumage avec lampe témoin. Roues pivotantes. 1 étagère isolée.
-  **TELLERWÄRM MÖBEL.** Gestell aus rostfreiem Stahl. Regulierbares Thermostat: 30°-90°C. Beschrückung V230 50/60 Hz. Einschalter mit Kontrollampe. Pirouettierende Rollen. 1 isolierte Etage.



MS 1860	€ 940,00
DIMENSIONI ESTERNE LxPxH cm EXTERNAL DIMENSIONS LxPxH cm DIMENSIONS EXTERIEURES LxPxH cm AUBENABMESSUNGEN LxPxH cm	39x42x95 h
	800 W
Portata 60 piatti - Capacity 60 plates Capacité 60 assiettes - Tragfähigkeit 60 Teller	

MS 1862	€ 1.180,00
DIMENSIONI ESTERNE LxPxH cm EXTERNAL DIMENSIONS LxPxH cm DIMENSIONS EXTERIEURES LxPxH cm AUBENABMESSUNGEN LxPxH cm	70x42x80 h
	800 W
Portata 100 piatti - Capacity 100 plates Capacité 100 assiettes - Tragfähigkeit 100 Teller	

MS 1866	€ 1.240,00
DIMENSIONI ESTERNE LxPxH cm EXTERNAL DIMENSIONS LxPxH cm DIMENSIONS EXTERIEURES LxPxH cm AUBENABMESSUNGEN LxPxH cm	70x42x95 h
	800 W
Portata 120 piatti - Capacity 120 plates Capacité 120 assiettes - Tragfähigkeit 120 Teller	

Vetrine bar - Showcases for bar Vitrines pour bar - Bar-warmvitrinen

IT VETRINE RISCALDATE E NEUTRE. Costruite in acciaio inox. Fianchi e antine sui due fronti in plexiglass trasparente. Ripiano di base e intermedio estraibili. Riscaldamento a mezzo resistenza con regolazione della temperatura a mezzo termostato 30/90 °C, interruttore luminoso e lampada spia di funzionamento. Cavo con spina. Dispositivo di umidificazione.

UK WARMED DISPLAY-CASES AND NEUTRAL. Built in stainless steel. Front doors and sides in plexiglass. Heating by heater with thermostats removable bottom intermediate shelves 30/90 °C and signal lamp. On/off lighting switch: cable with and plug. Humidification device.



Vetrina riscaldata inox - 1 piano
Warming display in stainless steel - 1 shelf
Vitrine chauffant en acier inox - 1 étage
Warmvitrine aus rostfreiem Stahl - 1 Etage

VBR 4751 (L. 50) € 300,00

LUNGA - LENGTH - LONGUEUR - LÄNGE cm **50**

DIMENSIONI ESTERNE - EXTERNAL DIMENSIONS LxPxH cm **50x35x25 h**
DIMENSIONS EXTERIEURES - AUßENABMESSUNGEN LxPxH cm

V 230 50/60 Hz 250 W

VBR 4781 (L. 85) € 390,00

LUNGA - LENGTH - LONGUEUR - LÄNGE cm **85**

DIMENSIONI ESTERNE - EXTERNAL DIMENSIONS LxPxH cm **85x35x25 h**
DIMENSIONS EXTERIEURES - AUßENABMESSUNGEN LxPxH cm

V 230 50/60 Hz 400 W

FR VITRINES CHAUFFÉES ET NEUTRES. Construction en acier inox. Cotés et portes sur les deux façades en plexiglass transparent. Chauffage par résistance bindée avec thermostat de réglage 30/90° C et lampe témoin. Interrupteur on/off. Cable avec prise. Humidificateur.

DE HEISSE UND NEUTRALE VITRINEN. Aufbau aus rostfreiem Stahl. Seiten und Türen aus durchsichtigem Plexiglass. Heizung durch Heizkörper mit Temperaturregelung durch thermostat 30/90 °C mit Kontrolleuchte. Ein/Aus Leuchtschalter; Kabel mit Stecker. Befeuchter.



Vetrina neutra inox - 1 piano
Stainless steel displav - 1 shelf
Vitrine en acier inox - 1 étage
Vitrine aus rostfreiem Stahl - 1 Etage

VBN 4751 (L. 50) € 180,00

LUNGA - LENGTH - LONGUEUR - LÄNGE cm **50**

DIMENSIONI ESTERNE - EXTERNAL DIMENSIONS LxPxH cm **50x35x22 h**
DIMENSIONS EXTERIEURES - AUßENABMESSUNGEN LxPxH cm

VBN 4781 (L. 85) € 240,00

LUNGA - LENGTH - LONGUEUR - LÄNGE cm **85**

DIMENSIONI ESTERNE - EXTERNAL DIMENSIONS LxPxH cm **85x35x22 h**
DIMENSIONS EXTERIEURES - AUßENABMESSUNGEN LxPxH cm

Optionals

PRI 50 Piano intermedio riscaldato W. 250 - Middle shelf heated - Etagère moyenne chauffée - Erwärmte Zwischenplatte **€ 140,00**

PRI 85 Piano intermedio riscaldato W. 250 - Middle shelf heated - Etagère moyenne chauffée - Erwärmte Zwischenplatte **€ 180,00**

Vetrine bar - Showcases for bar
Vitrines pour bar - Bar-warmvitrinen



Vetrina riscaldata inox - 2 piano
 Warming display in stainless steel - 2 shelf
 Vitrine chauffant en acier inox - 2 étage
 Warmvitrine aus rostfreiem Stahl - 2 Etage

VBR 4752 (L. 50)	€ 400,00
LUNGA - LENGTH - LONGUEUR - LÄNGE cm	50
DIMENSIONI ESTERNE - EXTERNAL DIMENSIONS LxPxH cm DIMENSIONS EXTERIEURES - AUßENABMESSUNGEN LxPxH cm	50x35x40 h
V 230 50/60 Hz 250 W	
VBR 4782 (L. 85)	€ 510,00
LUNGA - LENGTH - LONGUEUR - LÄNGE cm	85
DIMENSIONI ESTERNE - EXTERNAL DIMENSIONS LxPxH cm DIMENSIONS EXTERIEURES - AUßENABMESSUNGEN LxPxH cm	85x35x40 h
V 230 50/60 Hz 400 W	

Vetrina neutra inox - 2 piano
 Stainless steel displav - 2 shelf
 Vitrine en acier inox - 2 étage
 Vitrine aus rostfreiem Stahl - 2 Etage

VBN 4752 (L. 50)	€ 280,00
LUNGA - LENGTH - LONGUEUR - LÄNGE cm	50
DIMENSIONI ESTERNE - EXTERNAL DIMENSIONS LxPxH cm DIMENSIONS EXTERIEURES - AUßENABMESSUNGEN LxPxH cm	50x35x36 h
VBN 4782 (L. 85)	€ 360,00
LUNGA - LENGTH - LONGUEUR - LÄNGE cm	85
DIMENSIONI ESTERNE - EXTERNAL DIMENSIONS LxPxH cm DIMENSIONS EXTERIEURES - AUßENABMESSUNGEN LxPxH cm	85x35x36 h





Vetrina riscaldata inox - 3 piano
 Warming display in stainless steel - 3 shelf
 Vitrine chauffant en acier inox - 3 étage
 Warmvitrine aus rostfreiem Stahl - 3 Etage



VBR 4753 (L. 50)	€ 490,00
LUNGA - LENGTH - LONGUEUR - LÄNGE cm	50
DIMENSIONI ESTERNE - EXTERNAL DIMENSIONS LxPxH cm DIMENSIONS EXTERIEURES - AUßENABMESSUNGEN LxPxH cm	50x35x54 h
V 230 50/60 Hz 400 W	
VBR 4783 (L. 85)	€ 630,00
LUNGA - LENGTH - LONGUEUR - LÄNGE cm	85
DIMENSIONI ESTERNE - EXTERNAL DIMENSIONS LxPxH cm DIMENSIONS EXTERIEURES - AUßENABMESSUNGEN LxPxH cm	85x35x54 h
V 230 50/60 Hz 400 W	

Vetrina neutra inox - 3 piano
 Stainless steel displav - 3 shelf
 vitrine en acier inox - 3 étage
 Vitrine aus rostfreiem Stahl - 3 Etage

VBN 4753 (L. 50)	€ 370,00
LUNGA - LENGTH - LONGUEUR - LÄNGE cm	50
DIMENSIONI ESTERNE - EXTERNAL DIMENSIONS LxPxH cm DIMENSIONS EXTERIEURES - AUßENABMESSUNGEN LxPxH cm	50x35x50 h
VBN 4783 (L. 85)	€ 470,00
LUNGA - LENGTH - LONGUEUR - LÄNGE cm	85
DIMENSIONI ESTERNE - EXTERNAL DIMENSIONS LxPxH cm DIMENSIONS EXTERIEURES - AUßENABMESSUNGEN LxPxH cm	85x35x50 h

Vetrine bar - Showcases for bar Vitrines pour bar - Bar-warmvitrinen

-  Vetrina riscaldata ventilata da banco per alimenti. Con doppio vetro. Termostato manuale +30+90 °C.
-  Ventilated tabletop heated showcase for food. With double glass. Manual thermostat +30+90 °C.

-  Vitrine chaude de table ventilée pour aliments. Avec double verre. Thermostat manuel +30+90 °C.
-  Ventilierter Warmhaltevitruine fuer Speise. Tischgerät. Mit Doppelglas. Manuelles Thermostat +30+90 °C.



VPH 100

€ 565,00

DIMENSIONI ESTERNE - EXTERNAL DIMENSIONS LxPxH cm
DIMENSIONS EXTERIEURES - AUBENABMESSUNGEN LxPxH cm

71x46x67 h

V 230 50/60 Hz 1100 W

Vetrina riscaldata - 2 griglie
Warming display - 2 grids
Vitrine chauffant - 2 grilles
Warmvitruine - 2 Roste

VPH 120

€ 750,00

DIMENSIONI ESTERNE - EXTERNAL DIMENSIONS LxPxH cm
DIMENSIONS EXTERIEURES - AUBENABMESSUNGEN LxPxH cm

71x58x67 h

V 230 50/60 Hz 1100 W

Vetrina riscaldata - 2 griglie
Warming display - 2 grids
Vitrine chauffant - 2 grilles
Warmvitruine - 2 Roste

VPH 160

€ 890,00



DIMENSIONI ESTERNE - EXTERNAL DIMENSIONS LxPxH cm
DIMENSIONS EXTERIEURES - AUBENABMESSUNGEN LxPxH cm



88x58x67 h

V 230 50/60 Hz 1100 W

Vetrina riscaldata - 2 griglie
Warming display - 2 grids
Vitrine chauffant - 2 grilles
Warmvitruine - 2 Roste

Vitrine bar - Showcases for bar
Vitrines pour bar - Bar-warmvitrinen

-  **PORTA BriocheS - Croissants.** Piano in legno. Cupola in plx con antine apribili su 2 lati.
-  **PASTRY-HOLDER.** Wooden shelf. PLX cover with doors opening on both sides.

-  **PORTE-GÂTEAU.** Étagère en bois. Convercle en PLX avec portes ouvrables sur les deux côtés.
-  **GEBÄCKHALTER.** Etage aus Holz. Deckel aus PLX mit aufklappbaren Türen auf beiden Seiten.



VL 4748 (L. 50) € 160,00

DIMENSIONI ESTERNE - EXTERNAL DIMENSIONS LxPxH cm **50x35x21 h**
 DIMENSIONS EXTERIEURES - AUßENABMESSUNGEN LxPxH cm

VL 4749 (L. 85) € 190,00

DIMENSIONI ESTERNE - EXTERNAL DIMENSIONS LxPxH cm **85x35x21 h**
 DIMENSIONS EXTERIEURES - AUßENABMESSUNGEN LxPxH cm



WENGÉ

WENGÉ

VL 4748W (L. 50) € 160,00

DIMENSIONI ESTERNE - EXTERNAL DIMENSIONS LxPxH cm **50x35x21 h**
 DIMENSIONS EXTERIEURES - AUßENABMESSUNGEN LxPxH cm

VL 4749W (L. 85) € 190,00

DIMENSIONI ESTERNE - EXTERNAL DIMENSIONS LxPxH cm **85x35x21 h**
 DIMENSIONS EXTERIEURES - AUßENABMESSUNGEN LxPxH cm



LACCATO LUCIDO BIANCO - WHITE POLISH VARNISHED
 BLANC LOQUÉ BRILLANT - GLANZWEISS LACKIERT

LACCATO LUCIDO BIANCO - WHITE POLISH VARNISHED
 BLANC LOQUÉ BRILLANT - GLANZWEISS LACKIERT





VL 4748B (L. 50) € 180,00

DIMENSIONI ESTERNE - EXTERNAL DIMENSIONS LxPxH cm **50x35x21 h**
 DIMENSIONS EXTERIEURES - AUßENABMESSUNGEN LxPxH cm

VL 4749B (L. 85) € 210,00

DIMENSIONI ESTERNE - EXTERNAL DIMENSIONS LxPxH cm **85x35x21 h**
 DIMENSIONS EXTERIEURES - AUßENABMESSUNGEN LxPxH cm

Vetrine bar - Showcases for bar Vitrines pour bar - Bar-warmvitrinen

-  Vetrinetta porta croissants e dolci. Struttura unica completamente in plexiglass con antine apribili sui due lati.
-  Vitrine porte-croissants et gâteaux. Structure unique en plexiglass avec portes s'ouvrant sur les deux côtés.
-  Show-case for croissants and cakes. Single plexiglass structure with doors opening on both sides.
-  Vitrine für Croissants und Kuchen. Einzelstruktur aus Plexiglass mit aufklappbaren Türen auf beiden Seiten.



VETRINA NEUTRA - 1 PIANO / DISPLAY - 1 SHELF
VITRINE - 1 ÉTAGE / VITRINE - 1 ETAGE

VBE 50 (L. 50)

€ 140,00

DIMENSIONI ESTERNE - EXTERNAL DIMENSIONS LxPxH cm
DIMENSIONS EXTERIEURES - AUßENABMESSUNGEN LxPxH cm

50x35x18 h



VETRINA NEUTRA - 1 PIANO / DISPLAY - 1 SHELF
VITRINE - 1 ÉTAGE / VITRINE - 1 ETAGE

VBE 85 (L. 85)

€ 185,00

DIMENSIONI ESTERNE - EXTERNAL DIMENSIONS LxPxH cm
DIMENSIONS EXTERIEURES - AUßENABMESSUNGEN LxPxH cm

85x35x18 h

Carrelli portavassoi



Carrelli portavassoi rinforzati
Carrelli portavassoi universali
Carrelli portateglie GN
Carrelli portateglie per pasticceria
Carrelli portateglie GN rinforzati
Carrelli portateglie per pasticceria rinforzati

Tray-holder trolley



Reinforced tray-holder trolley
Universal tray-holder trolley
GN pan trolley
Tray rack trolley for bakeries
Reinforced GN pan trolley
Reinforced tray rack trolley for bakeries

Chariot porte-plateaux



Chariot porte-plateaux renforcés
Chariot porte-plateaux universels
Chariots portes-plaques GN
Chariot porte-plaques à pâtisserie
Chariot porte-plaques GN renforcés
Chariot porte-plaques à pâtisserie renforcés

Tablettwagen



Verstärkte Tablettwagen
Universale Tablettwagen
GN Auflaufformenwagen
Auflaufformen-Wagen für Konditoreibetriebe
Verstärkte GN Auflaufformenwagen
Verstärkte Auflaufformen-Wagen für Konditoreibetriebe

Carrelli portavassoi - Tray-holder trolley **Chariot porte-plateaux - Tablettwagen**

 Struttura in acciaio inox. Guide in acciaio inox. Ruote multidirezionali. paracolpi in gomma. Questi carrelli predisposti di serie per i vassoi GN 1/1 (dim. mm 530 x 325) sono realizzati a richiesta per qualsiasi tipo di vassoio. Optional: vaschetta portabottiglie inox o ABS.

 Stainless steel structure. Stainless steel slide-ways. Multidirectional wheels. Rubber buffer. Serial trolleys are made for Gn 1/1 trays (530 x 325 mms) but we can make trolleys on request for any type of tray. Optional: stainless steel or ABS bottle-holder.



Portavassoi per n. 10 vassoi
Tray holder for 10 trays
Porte plateaux pour 10 plateaux
Tablettwagen für n. 10 Tabletten

CA 1450

€ 300,00

DIMENSIONI ESTERNE - EXTERNAL DIMENSIONS LxPxH cm
DIMENSIONS EXTERIEURES - AUßENABMESSUNGEN LxPxH cm

38x62x175 h



Portavassoi per n. 20 vassoi
Tray holder for 20 trays
Porte plateaux pour 20 plateaux
Tablettwagen für n. 20 Tabletten

CA 1460

€ 450,00

DIMENSIONI ESTERNE - EXTERNAL DIMENSIONS LxPxH cm
DIMENSIONS EXTERIEURES - AUßENABMESSUNGEN LxPxH cm

74x62x175 h

Carrelli portavassoio - Tray-holder trolley Chariot porte-plateaux - Tablettwagen

Structure en acier inoxydable. Coulis en acier inoxydable. Roues pivotantes. Butoir engomme. Les chariots sont produits en serie pour les plateaux GN 1/1 (dim. 530x325 mm) mais ils peuvent etre réalisés pour m'importe quel type de plateau. Optionnel: cuvette porte-bouteilles en acier inoxydable / ou ABS.

Gestell und Schienen aus rostfreiem Stahl. Leichtlaufende Rollen. Gummipuffer. Diese Tablettwagen realisiert für Tabletten GN 1/1 (Abmessungen 530 x 325) sind können auf Anfrage für jede Art. von Tablett hergestellt sein. Sonderzubehör: Flaschenhalter aus rostfreiem Stahl oder aus ABS.



Portavassoio per n. 30 vassoio
Tray holder for 30 trays
Porte plateaux pour 30 plateaux
Tablettwagen für n. 30 Tabletten

CA 1470

€ 600,00

DIMENSIONI ESTERNE - EXTERNAL DIMENSIONS LxPxH cm
DIMENSIONS EXTERIEURES - AUßENABMESSUNGEN LxPxH cm

110x62x175 h



Bacinella portabottiglie in ABS
ABS bottle-holder tank
Cuvette porte-bouteilles en ABS
Flaschenhalterschüssel aus ABS

A 510

€ 43,00

Bacinella portabottiglie in acciaio inox
Stainless steel bottle-holder tank
Cuvette porte-bouteilles en acier inoxydable
Flaschenhalterschüssel aus rostfreiem Stahl

A 500

€ 80,00

Optionals

A 512 Ruote con freno - Wheels with catch
Roues avec frein - Räder mit Bremse

€ 7,00 cad./each

ATTENZIONE: SPECIFICARE LE MISURE DEL VASSOIO ALL'ORDINE - **WARNING:** TRAY DIMENSIONS TO BE SPECIFIED WHEN ORDERING
ATTENTION: DIMENSIONS DU PLATEAU À SPÉCIFIER LORS DE LA COMMANDE - **ACHTUNG:** BEI DER BESTELLUNG DIE TABLETTABMESSUNGEN MITTEILEN

Carrelli portavassoi - Tray-holder trolley Chariot porte-plateaux - Tablettwagen

- Con pannelli laterali in perflex bianco o acciaio inox o wengè. A richiesta optional pannello posteriore.
- With side panels in white perflex or stainless steel or wengè. On demand back panel with surcharge.

- Avec panneaux latéraux en perflex blanc ou acier inox ou wengè. Sur demande panneau arrière avec supplément de prix.
- Mit Seitenplatten aus Perflex Weiss oder Edelstahl oder Wengè. Auf Anfrage, mit Aufpreis, Rückplatte.



Portavassoi per n. 10 vassoi. Pannellato laterale in perflex bianco.
Tray holder for 10 trays. Side panels in white perflex.
Porte plateaux pour 10 plateaux. Panneaux latéraux en perflex blanc.
Tablettwagen für n. 10 Tabletten, seitlich getäfelt aus Perflex weiss.

CA 1450P € 350,00

Come sopra con pannelli laterali inox.
See above with stainless steel lateral panels.
Comme ci-dessus avec panneaux latéraux en inox.
Wie oben mit Seitenplatten aus Edelstahl.

CA 1450PI € 420,00

Come sopra con pannelli laterali wengè.
As above with wengè lateral panels.
Comme ci-dessus avec panneaux latéraux en wengè.
Wie oben mit Seitenplatten aus Wengè.

CA 1450PW € 380,00

DIMENSIONI ESTERNE - EXTERNAL DIMENSIONS LxPxH cm
DIMENSIONS EXTERIEURES - AUßENABMESSUNGEN LxPxH cm **38x62x175 h**

Portavassoi per n. 20 vassoi Pannellato laterale in perflex bianco.
Tray holder for 20 trays. Side panels in white perflex.
Porte plateaux pour 20 plateaux. Panneaux latéraux en perflex blanc.
Tablettwagen für n. 20 Tabletten, seitlich getäfelt aus Perflex weiss.

CA 1460P € 500,00

Come sopra con pannelli laterali inox.
See above with stainless steel lateral panels.
Comme ci-dessus avec panneaux latéraux en inox.
Wie oben mit Seitenplatten aus Edelstahl.

CA 1460PI € 570,00

Come sopra con pannelli laterali wengè.
As above with wengè lateral panels.
Comme ci-dessus avec panneaux latéraux en wengè.
Wie oben mit Seitenplatten aus Wengè.

CA 1460PW € 530,00

DIMENSIONI ESTERNE - EXTERNAL DIMENSIONS LxPxH cm
DIMENSIONS EXTERIEURES - AUßENABMESSUNGEN LxPxH cm **74x62x175 h**

**A RICHIESTA OPTIONAL PANNELLO POSTERIOR - ON DEMAND BACK PANEL WITH SURCHARGE
SUR DEMANDE PANNEAU ARRIÈRE AVEC SUPPLEMENT DE PRIX - AUF ANFRAGE, MIT AUFPREIS, RÜCKPLATTE**

Carrelli portavassoio - Tray-holder trolley
Chariot porte-plateaux - Tablettwagen



Portavassoio per n. 30 vassoio. Pannellato laterale in perfix bianco.
 Tray holder for 30 trays. Side panels in white perfix.
 Porte plateaux pour 30 plateaux. Panneaux latéraux en perfix blanc.
 Tablettwagen für n. 30 Tabletten, seitlich getäfelt aus Perfix weiss.

CA 1470P € 660,00

Come sopra con pannelli laterali inox.
 See above with stainless steel lateralpanels.
 Comme ci-dessus avec panneaux latéraux en inox.
 Wie oben mit Seitenplatten aus Edelstahl.

CA 1470PI € 720,00

Come sopra con pannelli laterali wengè.
 As above with wengè lateral panels.
 Comme ci-dessus avec panneaux latéraux en wengé.
 Wie oben mit Seitenplatten aus Wengé.

CA 1470PW € 700,00

DIMENSIONI ESTERNE - EXTERNAL DIMENSIONS LxPxH cm **110x62x175 h**
 DIMENSIONS EXTERIEURES - AUBENABMESSUNGEN LxPxH cm



Bacinella portabottiglie in ABS
 ABS bottle-holder tank
 Cuvette porte-bouteilles en ABS
 Flaschenhalterschüssel aus ABS

A 510 € 43,00

Bacinella portabottiglie in acciaio inox
 Stainless steel bottle-holder tank
 Cuvette porte-bouteilles en acier inoxydable
 Flaschenhalterschüssel aus rostfreiem Stahl

A 500 € 80,00

Optionals

A 512 Ruote con freno - Wheels with catch **€ 7,00 cad./each**
 Roues avec frein - Räder mit Bremse

ATTENZIONE: SPECIFICARE LE MISURE DEL VASSOIO ALL'ORDINE
WARNING: TRAY DIMENSIONS TO BE SPECIFIED WHEN ORDERING
ATTENTION: DIMENSIONS DU PLATEAU À SPÉCIFIER LORS DE LA COMMANDE
ACHTUNG: BEI DER BESTELLUNG DIE TABLETTABMESSUNGEN MITTEILEN

A RICHIESTA OPTIONAL PANNELLO POSTERIOR - ON DEMAND BACK PANEL WITH SURCHARGE
SUR DEMANDE PANNEAU ARRIÈRE AVEC SUPPLEMENT DE PRIX - AUF ANFRAGE, MIT AUFPREIS, RÜCKPLATTE

Carrelli portavassoi rinforzati - Reinforced tray-holder trolley

Chariot porte-plateaux renforcés - Verstärkte Tablettwagen

 Struttura in acciaio inox 25x25. Guide in acciaio inox sp. 1,2. Ruote multidirezionali, paracolpi in gomma. Questi carrelli predisposti in serie per i vassoi GN 1/1 (dim. mm 530x325) sono realizzati a richiesta per qualsiasi tipo di vassoio. Optional: vaschetta portabottiglie inox o ABS.

 Stainless steel structure. Stainless steel slide-ways. Multidirectional wheels. Rubber duffer. Serial trolleys are made for Gn 1/1 trays (530x325 mm) but we can make trolleys on request for any of tray. Optional: stainless steel or ABS bottle-holder.

 Structure en acier inoxydable. Coulis en acier inoxydable. Roues pivotantes. Butoir en gomme. Les chariots sont produits en serie pour les plateaux GN 1/1 (dim. 530x325 mm) mais ils peuvent être réalisés pour n'importe quel type de plateau. Optional: cuvette porte-bouteilles en acier inoxydable / ou ABS.

 Gestell und Schiegeleiten aus rostfreiem Stahl. Leichtlaufende Rollen. Gummipuffer. Diese Tablettwagen realisiert für Tabletten GN 1/1 (Abmessungen 530x325) sind können auf Anfrage für jede Art. von Tablett hergestellt sein. Sonderzubehör: Flaschenhalter aus rostfreiem Stahl oder aus ABS.



Portavassoi per n. 10 vassoi. - Tray holder for 10 trays.
Porte plateaux pour 10 plateaux. - Tablettwagen für n. 10 Tabletten.

CA 1451R € 360,00

Con pannelli laterali in PERFEX bianco. - With sides in white PERFEX.
Avec flancs en PERFEX blanc. - Mit Seiten aus weissen PERFEX.

CA 1451RP € 410,00

Con pannelli laterali in inox. - With sides in stainless steel.
Avec flancs en acier inox. - Mit Seiten aus Edelstahl.

CA 1451RPI € 480,00

DIMENSIONI ESTERNE - EXTERNAL DIMENSIONS LxPxH cm **38x62x175 h**
DIMENSIONS EXTERIEURES - AUßENABMESSUNGEN LxPxH cm

Portavassoi per n. 20 vassoi. - Tray holder for 20 trays.
Porte plateaux pour 20 plateaux. - Tablettwagen für n. 20 Tabletten.

CA 1461R € 550,00

Con pannelli laterali in PERFEX bianco. - With sides in white PERFEX.
Avec flancs en PERFEX blanc. - Mit Seiten aus weissen PERFEX.

CA 1461RP € 600,00

Con pannelli laterali in inox. - With sides in stainless steel.
Avec flancs en acier inox. - Mit Seiten aus Edelstahl.

CA 1461RPI € 670,00

DIMENSIONI ESTERNE - EXTERNAL DIMENSIONS LxPxH cm **74x62x175 h**
DIMENSIONS EXTERIEURES - AUßENABMESSUNGEN LxPxH cm

A RICHIESTA OPTIONAL PANNELLO POSTERIOR - ON DEMAND BACK PANEL WITH SURCHARGE
SUR DEMANDE PANNEAU ARRIÈRE AVEC SUPPLEMENT DE PRIX - AUF ANFRAGE, MIT AUFPREIS, RÜCKPLATTE

Carrelli portavassoi rinforzati - Reinforced tray-holder trolley
Chariot porte-plateaux renforcés - Verstärkte Tablettwagen



Portavassoi per n. 30 vassoi. - Tray holder for 30 trays.
 Porte plateaux pour 30 plateaux. - Tablettwagen für n. 30 Tabletten.

CA 1471R € 750,00

Con pannelli laterali in PERFEX bianco. - With sides in white PERFEX.
 Avec flancs en PERFEX blanc. - Mit Seiten aus weissen PERFEX.

CA 1471RP € 800,00

Con pannelli laterali in inox. - With sides in stainless steel.
 Avec flancs en acier inox. - Mit Seiten aus Edelstahl.

CA 1471RPI € 870,00

DIMENSIONI ESTERNE - EXTERNAL DIMENSIONS LxPxH cm
 DIMENSIONS EXTERIEURES - AUßENABMESSUNGEN LxPxH cm

110x62x175 h



Bacinella portabottiglie in ABS
 ABS bottle-holder tank
 Cuvette porte-bouteilles en ABS
 Flaschenhalterschüssel aus ABS

A 510 € 43,00

Bacinella portabottiglie in acciaio inox
 Stainless steel bottle-holder tank
 Cuvette porte-bouteilles en acier inoxydable
 Flaschenhalterschüssel aus rostfreiem Stahl

A 500 € 80,00

Optionals

A 514 Ruote con freno - Wheels with catch
 Roues avec frein - Räder mit Bremse € 9,00 cad./each

ATTENZIONE: SPECIFICARE LE MISURE DEL VASSOIO ALL'ORDINE
WARNING: TRAY DIMENSIONS TO BE SPECIFIED WHEN ORDERING
ATTENTION: DIMENSIONS DU PLATEAU À SPÉCIFIER LORS DE LA COMMANDE
ACHTUNG: BEI DER BESTELLUNG DIE TABLETTABMESSUNGEN MITTEILEN

A RICHIESTA OPTIONAL PANNELLO POSTERIOR - ON DEMAND BACK PANEL WITH SURCHARGE
SUR DEMANDE PANNEAU ARRIÈRE AVEC SUPPLEMENT DE PRIX - AUF ANFRAGE, MIT AUFPREIS, RÜCKPLATTE

Carrelli portavassoi universali - Universal tray-holder trolley Chariot porte-plateaux universels - Universale Tablettwagen

 Struttura in acciaio inox. Guide in filo di acciaio cromato. Ruote multidirezionali. Paracolpi in gomma.

 Stainless steel structure. Slide-ways in chromium-plated steel wire. Multidirectional wheel. Rubber buffer.

 Structure en acier inoxydable. Coulisseaux en fil d'acier chromé. Roues pivotantes. Butoir en gomme.

 Gestell aus Edelstahl. Schienen aus verchromtem Stahl. Leichtlaufende Rollen. Gummipuffer.



Portavassoi per n. 10 vassoi. - Tray holder for 10 trays.
Porte plateaux pour 10 plateaux. - Tablettwagen für n. 10 Tabletten.

CA 1455

€ 280,00

Come sopra con pannelli laterali in perfix.
See above with perfix lateral panels.
Comme ci dessus avec panneaux latéraux en perfix.
Wie oben mit Seitenplatten aus Perfe.

CA 1455P

€ 330,00

Come sopra con pannelli laterali inox.
See above with stainless steel lateral panels.
Comme ci dessus avec panneaux latéraux en inox.
Wie oben mit Seitenplatten aus Edelstahl.

CA 1455PI

€ 400,00

DIMENSIONI ESTERNE - EXTERNAL DIMENSIONS LxPxH cm
DIMENSIONS EXTERIEURES - AUßENABMESSUNGEN LxPxH cm

52x62x175 h



Portavassoi per n. 20 vassoi. - Tray holder for 20 trays.
Porte plateaux pour 20 plateaux. - Tablettwagen für n. 20 Tabletten.

CA 1465

€ 420,00

Come sopra con pannelli laterali in perfix.
See above with perfix lateral panels.
Comme ci dessus avec panneaux latéraux en perfix.
Wie oben mit Seitenplatten aus Perfe.

CA 1465P

€ 470,00

Come sopra con pannelli laterali inox.
See above with stainless steel lateral panels.
Comme ci dessus avec panneaux latéraux en inox.
Wie oben mit Seitenplatten aus Edelstahl.

CA 1465PI

€ 540,00

DIMENSIONI ESTERNE - EXTERNAL DIMENSIONS LxPxH cm
DIMENSIONS EXTERIEURES - AUßENABMESSUNGEN LxPxH cm

95x62x175 h

Optionals

A 512 Ruote con freno - Wheels with catch - Roues avec frein - Räder mit Bremse

€ 7,00 cad./each

Carrelli portavassoi universali - Universal tray-holder trolley Chariot porte-plateaux universels - Universale Tablettwagen

 Portateglie da banco per teglie tonde da cm. 26 a 32. Confezione minima 4 pz.

 Tabletop rack for round baking pans from 26 to 32 cm. Minimum package 4 pcs.

 Porte-plaques de table pour plaques rondes de 26 à 32 cm. Paquet minimum 4 pièces.

 Tischblechstaender fuer runde Bleche vom 26 bis 32 cm. Minimum Verpackung 4 St.



Portavassoi per n. 30 vassoi. - Tray holder for 30 trays.
Porte plateaux pour 30 plateaux. - Tablettwagen für n. 30 Tabletten.

CA 1475 € 550,00

Come sopra con pannelli laterali in perfix.
See above with perfix lateral panels.
Comme ci dessus avec panneaux latéraux en perfix.
Wie oben mit Seitenplatten aus Perfe.

CA 1475P € 600,00

Come sopra con pannelli laterali inox.
See above with stainless steel lateral panels.
Comme ci dessus avec panneaux latéraux en inox.
Wie oben mit Seitenplatten aus Edelstahl.

CA 1475PI € 670,00

DIMENSIONI ESTERNE - EXTERNAL DIMENSIONS LxPxH cm
DIMENSIONS EXTERIEURES - AUßENABMESSUNGEN LxPxH cm **138x62x175 h**

PT 15 € 58,00
DIMENSIONI ESTERNE - EXTERNAL DIMENSIONS LxPxH cm
DIMENSIONS EXTERIEURES - AUßENABMESSUNGEN LxPxH cm **38x29x67 h**

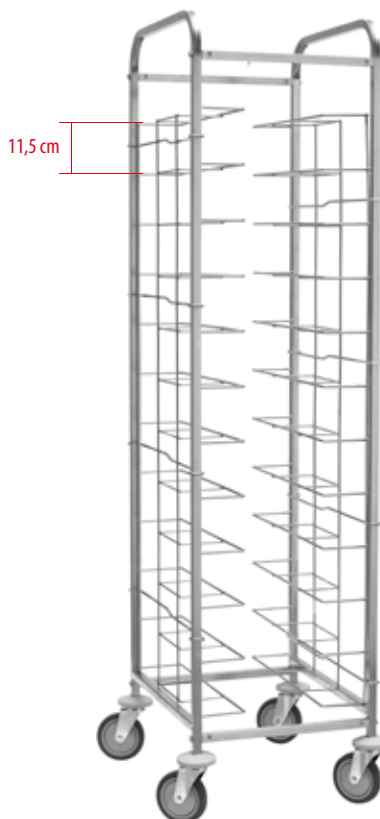

Portavassoi per n. 12 vassoi. - Tray holder for 12 trays.
Porte plateaux pour 12 plateaux. - Tablettwagen für n. 12 Tabletten.

CA 1455 V12 € 340,00

DIMENSIONI ESTERNE - EXTERNAL DIMENSIONS LxPxH cm
DIMENSIONS EXTERIEURES - AUßENABMESSUNGEN LxPxH cm **52x62x185 h**

**A RICHIESTA OPTIONAL PANNELLO POSTERIOR - ON DEMAND BACK PANEL WITH SURCHARGE
SUR DEMANDE PANNEAU ARRIÈRE AVEC SUPPLEMENT DE PRIX - AUF ANFRAGE, MIT AUFPREIS, RÜCKPLATTE**

Carrelli portateglie GN - GN pan trolley

Chariots portes-plaques GN - GN Auflaufformenwagen

- Struttura in acciaio inox. Guide in acciaio inox. Ruote multidirezionali. Paracolpi in gomma. Carrelli predisposti di serie per teglie GN 2/1. A richiesta per altre misure.
- Stainless steel structure. Stainless steel slide-ways. Multidirectional wheels. Rubber buffer. Serial trolley are made for GN 2/1 boards, but we can make trolleys on request for any type of board.

- Structure en acier inoxydable. Coulisseaux en acier inoxydable. Roues pivotantes. Butoir en gomme. Les chariots sont produits en serie pour plaques GN 2/1, mais peuvent être réalisés à la demande pour n'importe quel type de plaque.
- Gestell und Schienen aus rostfreiem Stah. Leichtlaufende Rollen. Gummipuffer. Diese backformenwagen GN 2/1 Können auf Anfrage für jede Art von Backform hergestellt sein.



CA 1477

€ 390,00

PORTATA - CAPACITY
CAPACITÉ - TRAGFÄHIGKEIT

8 GN 2/1
0/OR/OU/ODER
16 GN 1/1

DIMENSIONI ESTERNE - EXTERNAL DIMENSIONS LxPxH cm
DIMENSIONS EXTERIEURES - AUßENABMESSUNGEN LxPxH cm

65x76x94 h

CA 1476

€ 420,00

PORTATA - CAPACITY
CAPACITÉ - TRAGFÄHIGKEIT

14 GN 2/1
0/OR/OU/ODER
28 GN 1/1

DIMENSIONI ESTERNE - EXTERNAL DIMENSIONS LxPxH cm
DIMENSIONS EXTERIEURES - AUßENABMESSUNGEN LxPxH cm

65x76x182 h

Optionals

A 512 Ruote con freno - Wheels with catch - Roues avec frein - Räder mit Bremse

€ 7,00 cad./each

Carrelli portateglie GN - GN pan trolley Chariots portes-plaques GN - GN Auflaufformwagen

🇮🇹 Struttura in acciaio inox. Guide in acciaio inox. Ruote multidirezionali. Paracolpi in gomma. Carrelli predisposti di serie per teglie GN 1/1. A richiesta per altre misure.

🇬🇧 Stainless steel structure. Stainless steel slide-ways. Multidirectional wheels. Rubber buffer. Serial trolley are made for GN 1/1 boards, but we can make trolleys on request for any type of board.

🇫🇷 Structure en acier inoxydable. Coulisseaux en acier inoxydable. Roues pivotantes. Butoir en gomme. Les chariots sont produits en serie pour plaques GN 1/1, mais peuvent être réalisés à la demande pour n'importe quel type de plaque.

🇩🇪 Gestell und Schienen aus rostfreiem Stah. Leichtlaufende Rollen. Gummipuffer. Diese Backformwagen GN 1/1 Können auf Anfrage für jede Art von Backform hergestellt sein.



CA 1478

€ 360,00

PORTATA - CAPACITY
CAPACITÉ - TRAGFÄHIGKEIT

8 GN 1/1

DIMENSIONI ESTERNE - EXTERNAL DIMENSIONS LxPxH cm
DIMENSIONS EXTERIEURES - AUßENABMESSUNGEN LxPxH cm

45x66x94 h



CA 1479

€ 370,00

PORTATA - CAPACITY
CAPACITÉ - TRAGFÄHIGKEIT

14 GN 1/1

DIMENSIONI ESTERNE - EXTERNAL DIMENSIONS LxPxH cm
DIMENSIONS EXTERIEURES - AUßENABMESSUNGEN LxPxH cm

45x66x182 h

Optionals

A 512 Ruote con freno - Wheels with catch - Roues avec frein - Räder mit Bremse

€ 7,00 cad./each

Carrelli portateglie GN rinforzati - Reinforced GN pan trolley

Chariot porte-plaques GN renforcés - Verstärkte GN Auflaufformenwagen

- Struttura in acciaio inox 25x25. Guide in acciaio inox sp. 1,2. Ruote multidirezionali, paracolpi in gomma.
- Stainless steel structure. Stainless steel slide-ways. Multidirectional wheels. Rubber duffer. Serial trolleys are made for Gn 2/1 boards, but we can make trolleys on request for any type of board.

- Structure en acier inoxydable. Coulis en acier inoxydable. Roues pivotantes. Butoir en gomme. Les chariots sont produits en serie pour plateaux GN 2/1, mais peuvent être realises à la demande pour n'emport quel type de plaque.
- Gestell und Schiegegen aus rostfreiem Stahl. Leichtlaufende Rollen. Gummipuffer. Diese backformwagen GN 2/1 Können auf Anfrage für jede Art von Backform horgestellt sein.



CA 1489R

€ 510,00

PORTATA - CAPACITY
CAPACITÉ - TRAGFÄHIGKEIT

14 GN 1/1

DIMENSIONI ESTERNE - EXTERNAL DIMENSIONS LxPxH cm
DIMENSIONS EXTERIEURES - AUßENABMESSUNGEN LxPxH cm

46x62x182 h

CA 1486R

€ 570,00

PORTATA - CAPACITY
CAPACITÉ - TRAGFÄHIGKEIT

14 GN 2/1
0/OR/OU/ODER
28 GN 1/1

DIMENSIONI ESTERNE - EXTERNAL DIMENSIONS LxPxH cm
DIMENSIONS EXTERIEURES - AUßENABMESSUNGEN LxPxH cm

66x72x182 h

Optionals

A 514 Ruote con freno - Wheels with catch - Roues avec frein - Räder mit Bremse

€ 9,00 cad./each

Carrelli portateglie per pasticceria rinforzati - Reinforced tray rack trolley for bakeries - Chariot porte-plaques à pâtisserie renforcés - Verstärkte Auflaufformen-Wagen für Konditoreibetriebe

- Per 14 teglie da 60x40 (su richiesta per qualsiasi teglia). Intera- mente in acciaio inox. Ruote multidirezionali.
- For 14 boards size 60x40 (on request for any board). Entirely stainless steel. Multidirectional wheels.
- Pour 14 plaques dim. 60x40 (sur demande pour n'importe quelle plaque). Entièrement en acier inoxydable Roues pivotantes.
- Für 14 Backformen Abmessungen 60x40 (auf Anfrage für Jede Form). Komplett aus rostfreiem Stahl. Leichtlaufende Rollen.



CA 1492R

€ 550,00

DIMENSIONI ESTERNE - EXTERNAL DIMENSIONS LxPxH cm
DIMENSIONS EXTERIEURES - AUßENABMESSUNGEN LxPxH cm

53x72x182 h

Optionals

A 514 Ruote con freno - Wheels with catch
Roues avec frein - Räder mit Bremse

€ 9,00 cad./each



Teglia Blurex - Blurex tray - Plaque Blurex - Blurex Form

AV 4947

€ 18,00

DIMENSIONI ESTERNE - EXTERNAL DIMENSIONS LxPxH cm
DIMENSIONS EXTERIEURES - AUßENABMESSUNGEN LxPxH cm

60x30x2 h

AV 4937

€ 18,00

DIMENSIONI ESTERNE - EXTERNAL DIMENSIONS LxPxH cm
DIMENSIONS EXTERIEURES - AUßENABMESSUNGEN LxPxH cm

60x40x2 h



Teglia alluminata - Aluminized pan - Pan aluminisé - Aluminisierte pan

AV 4950

€ 18,00

DIMENSIONI ESTERNE - EXTERNAL DIMENSIONS LxPxH cm
DIMENSIONS EXTERIEURES - AUßENABMESSUNGEN LxPxH cm

60x30x2 h

AV 4940

€ 18,00

DIMENSIONI ESTERNE - EXTERNAL DIMENSIONS LxPxH cm
DIMENSIONS EXTERIEURES - AUßENABMESSUNGEN LxPxH cm

60x40x2 h



Teglia in alluminio - Aluminium tray
Plateau en aluminium - Aluminiumschale

AV 4980





€ 20,00





DIMENSIONI ESTERNE - EXTERNAL DIMENSIONS LxPxH cm
DIMENSIONS EXTERIEURES - AUßENABMESSUNGEN LxPxH cm

60x40x2 h

Carrelli portateglie per pasticceria - Tray rack trolley for bakeries

Chariot porte-plaques à pâtisserie - Auflaufformen-Wagen für Konditoreibetriebe

-  Interamente in acciaio inox. Ruote multidirezionali. Per 20 teglie.
-  Entirely stainless steel. Multidirectional wheels. For 20 boards.
-  Entièrement en acier inoxydable. Roues pivotantes. Pour 20 plaques.
-  Komplett aus rostfreiem Stahl. Leichtlaufende Rollen. Für 20 Backformen.

-  Interamente in acciaio inox. Ruote multidirezionali. Per 40 teglie.
-  Entirely stainless steel. Multidirectional wheels. For 40 boards.
-  Entièrement en acier inoxydable. Roues pivotantes. Pour 40 plaques.
-  Komplett aus rostfreiem Stahl. Leichtlaufende Rollen. Für 40 Backformen.



CA 1480

€ 380,00

DIMENSIONI ESTERNE - EXTERNAL DIMENSIONS LxPxH cm
DIMENSIONS EXTERIEURES - AUßENABMESSUNGEN LxPxH cm

51x47x177 h

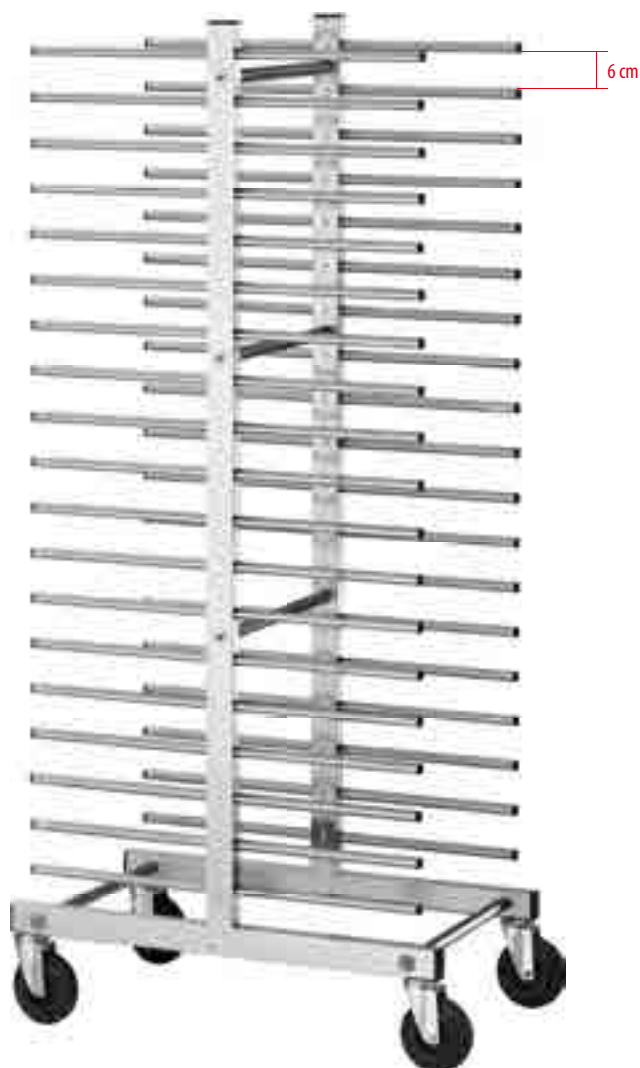

CA 1480D

€ 530,00

DIMENSIONI ESTERNE - EXTERNAL DIMENSIONS LxPxH cm
DIMENSIONS EXTERIEURES - AUßENABMESSUNGEN LxPxH cm

51x80x177 h

Optionals

A 512 Ruote con freno - Wheels with catch - Roues avec frein - Räder mit Bremse

€ 7,00 cad./each

Carrelli portateglie per pasticceria - Tray rack trolley for bakeries Chariot porte-plaques à pâtisserie - Auflaufformen-Wagen für Konditoreibetriebe

- 🇮🇹 Interamente in acciaio inox. Ruote multidirezionali. Per 14 teglie da 60 x 40 (su richiesta per qualsiasi teglia).
- 🇬🇧 Entirely stainless steel. Multidirectional wheels. For 14 boards size 60 x 40 (on request for any board).

- 🇫🇷 Entièrement en acier inoxydable. Roues pivotantes. Pour 14 plaques dim. 60 x 40 (sur demande pour n'importe quelle plaque).
- 🇩🇪 Komplett aus rostfreiem Stahl. Leichtlaufende Rollen. Für 14 Backformen Abmessungen 60 x 40 (auf Anfrage für Jede Form).



Per 14 teglie da 60x40
For 14 boards size 60x40
Pour 14 plaques dim. 60x40
Für 14 Backformen Abmessungen 60x40

CA 1482

€ 400,00

Portata 20 teglie 60x40, distanza fra le guide cm. 6.
Capacity 20 pans 60x40, distance between the runners cm. 6.
capacite 20 plaques 60x40, distance entre les glissieres 6 cm.
Tragfaehigkeit 20 backformen 60x40, abstand zwischen die schienen 6 cm.

CA 1482 T20

€ 500,00

DIMENSIONI ESTERNE - EXTERNAL DIMENSIONS LxPxH cm
DIMENSIONS EXTERIEURES - AUßENABMESSUNGEN LxPxH cm

52x72x182 h



Per 8 teglie da 60x40
For 8 boards size 60x40
Pour 8 plaques dim. 60x40
Für 8 Backformen Abmessungen 60x40

CA 1483

€ 365,00

DIMENSIONI ESTERNE - EXTERNAL DIMENSIONS LxPxH cm
DIMENSIONS EXTERIEURES - AUßENABMESSUNGEN LxPxH cm

52x72x94 h

Teglie: 8 pz. 80x60 / 16 pz. 60x40
Boards: 8 pcs. 80x60 / 16 pcs. 60x40
Plaques: 8 pcs. 80x60 / 16 pcs. 60x40
Backformen: 8 Stk. 80x60 / 16 Stk. 60x40

CA 1493

€ 400,00

DIMENSIONI ESTERNE - EXTERNAL DIMENSIONS LxPxH cm
DIMENSIONS EXTERIEURES - AUßENABMESSUNGEN LxPxH cm

85x65x94 h

Optionals

A 512 Ruote con freno - Wheels with catch - Roues avec frein - Räder mit Bremse

€ 7,00 cad./each

Carrelli portapiatti, vassoi e teglie

Carrello scolapiatti-bicchieri
Scolapiatti e bicchieri da muro
Cestelli per lavastoviglie 50x50
Portacestelli per lavastoviglie
Carrello portapiatti antipasti refrigerato a ventilazione
Carrello portapiatti antipasti riscaldato a resistenza W1600
Carrelli per ritiro, distribuzione e stoccaggio vassoi, piatti, tazze, ecc.
Carrello portapiatti

Dish, tray and pan carts

Dish and glass drying rack trolley
Dish and glass drying racks on wall
Racks for dishwashing machines
Dish washer tray trolley
Ventilated refrigeration trolley
Heated trolley for hors d'oeuvre dishes with heating element W1600
Trays, dishes, cups stacking and distribution trolleys. Stainless steel framework
Dish trolley





Chariot porte-assiettes, plateaux et plaques





Chariot égouttoir à vaisselle - verres
Egouttier pour assiettes et verres à mur
Paniers pour lave-vaisselle
Porte-paniers pour lave-vaisselle
Chariot porte-assiettes pour hors d'oeuvre réfrigéré à ventilation
Chariot porte-assiettes pour hors d'oeuvre chauffé avec résistance W1600
Chariots pour distribution et rangement de plateaux, assiettes et tasses
Chariots porte-assiettes

Geschirrwagen, Tablettts und Auflaufformen Tellerwagen

Abtropfwagen für Geschirr und Gläser
Abtropfwagen für Geschirr und Gläser für Wand
Körbe für Spülmaschine
Korbhalter für Spülmaschinen
Gekühlter tellerwagen für vorspeiseteller mit lüftung
Erwaermter tellerhalterwagen für vorspeiseteller mit thermoelement W1600
Wagen für Abdecken, Verteilung und Lagerung der Servierbretter, Teller ecc
Geschirrwagen

Carrelli portapiatti, vassoi e teglie - Dish, tray and pan carts - Chariot porte-assiettes, plateaux et plaques - Geschirrwagen, Tablett und Auflaufformen Tellerwagen.

-  PORTAPIATTI DA BANCO.
-  LUNCH COUNTER DISH HOLDER.
-  PORTE-ASSIETTES DE TABLE.
-  GESCHIRRWAGEN FÜR TISCH.

-  PORTAPIATTI DA MURO.
-  WALL PLATE HOLDER.
-  PORTE-ASSIETTES À MUR.
-  WAND-GESCHIRRWAGEN.



Griglia verniciata per piatti 18/23. Portata 48 piatti. Girevole da banco.
Painted grid. Capacity 48 plates. Revolving for table.
Grille peinte. Capacité 48 plats. Pivotant pour table.
Lackierter Rost. Tragfähigkeit 48 Teller. Drehbar für Tisch.

CA 1439 B

€ 325,00

Griglia cromata per piatti 18/23. Portata 48 piatti. Girevole da banco.
Chromed grid. Capacity 48 plates. Revolving for table.
Grille chromée. Capacité 48 plats. Pivotant pour table.
Verchromter Rost. Tragfähigkeit 48 Teller. Drehbar für Tisch.

CA 1440 B

€ 335,00

DIMENSIONI ESTERNE - EXTERNAL DIMENSIONS LxPxH cm
DIMENSIONS EXTERIEURES - AUßENABMESSUNGEN LxPxH cm

60x60x100 h

Griglia verniciata per piatti 25/31. Portata 48 piatti. Girevole da banco.
Painted grid for dishes 25/31. Capacity 48 plates. Revolving for table.
Grille peinte pour assiettes 25/31. Capacité 48 plats. Pivotant pour table.
Lackierter Rost für Teller 25/31. Tragfähigkeit 48 Teller. Drehbar für Tisch.

CA 1439 BG

€ 330,00

Griglia cromata per piatti 25/31. Portata 48 piatti. Girevole da banco.
Chromed grid for dishes 25/31. Capacity 48 plates. Revolving for table.
Grille chromée pour assiettes 25/31. Capacité 48 plats. Pivotant pour table.
Verchromter Rost für Teller 25/31. Tragfähigkeit 48 Teller. Drehbar für Tisch.

CA 1440 BG

€ 355,00

DIMENSIONI ESTERNE - EXTERNAL DIMENSIONS LxPxH cm
DIMENSIONS EXTERIEURES - AUßENABMESSUNGEN LxPxH cm

70x70x100 h



Portata 12 piatti. Da parete per piatti 18/23
Capacity 12 plates. For wall
Capacité 12 plats. Mural
Tragfähigkeit 12 Teller. Für Wand

CA 1439 P

€ 75,00

DIMENSIONI ESTERNE - EXTERNAL DIMENSIONS LxPxH cm
DIMENSIONS EXTERIEURES - AUßENABMESSUNGEN LxPxH cm

42x20x90 h

Carrelli portapiatti, vassoi e teglie - Dish, tray and pan carts - Chariot porte-assiettes, plateaux et plaques - Geschirrwagen, Tablett und Auflaufformen Tellerwagen.

 **CARRELLI PORTAPIATTI.** Struttura in acciaio plastificato con base in lamiera antipolvere. Griglie plastificate o cromate. Maniglie per conduzione carrello. Ruote Ø 125 di cui due con freno.

 **DISH CARTS.** Structure in plastic-coated steel with base in dust-proof sheet metal. Racks in rilsan plastic-coated or chromed steel. Side handles to steer trolley. Wheels diam. 125, two with brake.

 **CHARIOTS PORTE-ASSIETTES.** Structure en acier plastifié avec base en tôle antipoussière. Grilles plastifiées Rilsan ou chromées. Poignées de conduite du chariot. Roulettes Ø 125 dont deux, à frein.

 **GESCHIRRWAGEN.** Struktur aus plastifiziertem Stahl mit Basis aus Staubabweisendem Blech. Roste mit Rilsan plastifiziert oder verchromt. Griffe zum Fahren des Wagens. Räder Ø 125, davon zwei mit Bremse.

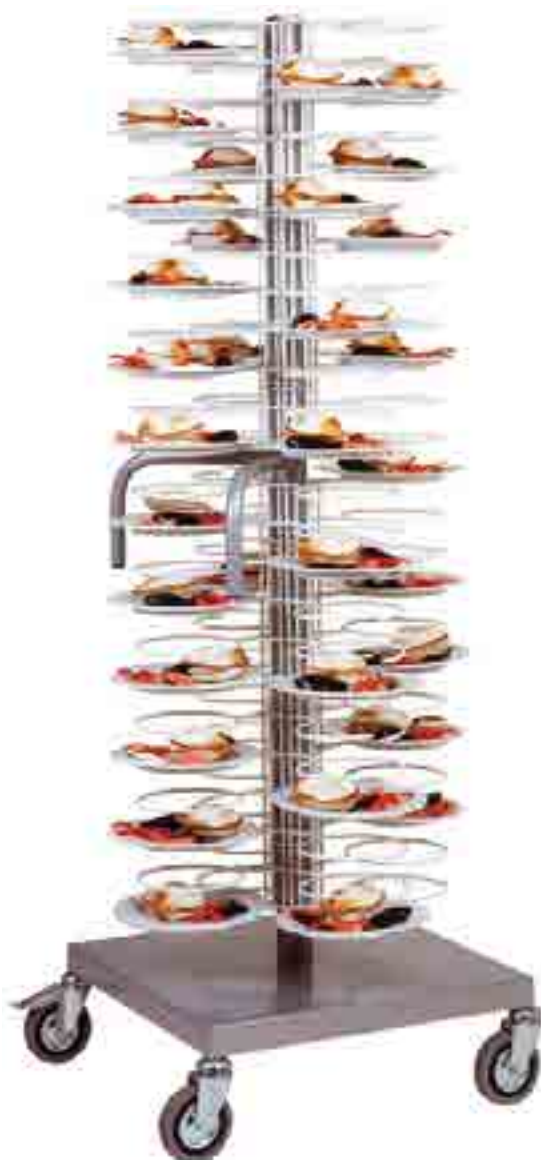

Portata 96 piatti. Griglie verniciate per piatti 18/23

Capacity 96 plates. Polished racks

Capacité 96 plats. Grilles vernies

96 Teller. Lackierte Gitter Tragfähigkeit

CA 1439

€ 560,00

Portata 96 piatti. Griglie cromate per piatti 18/23

Capacity 96 plates. Chromium-plated racks

Capacité 96 plats. Grilles chromées

Tragfähigkeit 96 Teller. Verchromte Roste

CA 1440

€ 580,00

DIMENSIONI ESTERNE - EXTERNAL DIMENSIONS LxPxH cm

DIMENSIONS EXTERIEURES - AUßENABMESSUNGEN LxPxH cm

60x60x175 h

Portata 96 piatti. Griglie verniciate per piatti 25-31

Capacity 96 plates. Polished racks

Capacité 96 plats. Grilles vernies

Tragfähigkeit 96 Teller. Lackierte Gitter

CA 1439 G

€ 590,00

Portata 96 piatti. Griglie cromate per piatti 25-31

Capacity 96 plates. Chromium-plated racks

Capacité 96 plats. Grilles chromées

Tragfähigkeit 96 Teller. Verchromte Roste

CA 1440 G

€ 620,00

DIMENSIONI ESTERNE - EXTERNAL DIMENSIONS LxPxH cm

DIMENSIONS EXTERIEURES - AUßENABMESSUNGEN LxPxH cm

70x70x175 h

Optionals

A 410

CA1439-40

Copertura in PVC con 4 cerniere - PVC lid with 4 hinges - Couverture en PVC avec 4 charnières - PVC-Abdeckung mit 4 Scharnieren

€ 200,00

A 420

CA 1439G-40G

Copertura in PVC con 4 cerniere - PVC lid with 4 hinges - Couverture en PVC avec 4 charnières - PVC-Abdeckung mit 4 Scharnieren

€ 230,00

Carrelli portapiatti, vassoi e teglie - Dish, tray and pan carts - Chariot porte-assiettes, plateaux et plaques - Geschirrwagen, Tablets und Auflaufformen Tellerwagen.

NEW



Griglia verniciata per piatti 18/23. Portata 48 piatti. da banco
Painted grid. Capacity 48 plates. for table
Grille peinte. Capacité 48 plats. pour table
Lackierter Rost. Tragfähigkeit 48 Teller. für Tisch

CA 1435

€ 275,00

Griglia cromata per piatti 18/23. Portata 48 piatti. da banco
Chromed grid. Capacity 48 plates. for table
Grille chromée. Capacité 48 plats. pour table
Verchromter Rost. Tragfähigkeit 48 Teller. für Tisch

CA 1436

€ 280,00

DIMENSIONI ESTERNE - EXTERNAL DIMENSIONS LxPxH cm
DIMENSIONS EXTERIEURES - AUßENABMESSUNGEN LxPxH cm

60x60x83 h

Griglia verniciata per piatti 25/31. Portata 48 piatti. da banco
Painted grid for dishes 25/31. Capacity 48 plates. for table
Grille peinte pour assiettes 25/31. Capacité 48 plats. pour table
Lackierter Rost für Teller 25/31. Tragfähigkeit 48 Teller. für Tisch

CA 1435 G

€ 285,00

Griglia cromata per piatti 25/31. Portata 48 piatti. da banco
Chromed grid for dishes 25/31. Capacity 48 plates. for table
Grille chromée pour assiettes 25/31. Capacité 48 plats. pour table
Verchromter Rost für Teller 25/31. Tragfähigkeit 48 Teller. für Tisch

CA 1436 G

€ 300,00

DIMENSIONI ESTERNE - EXTERNAL DIMENSIONS LxPxH cm
DIMENSIONS EXTERIEURES - AUßENABMESSUNGEN LxPxH cm

70x70x83 h

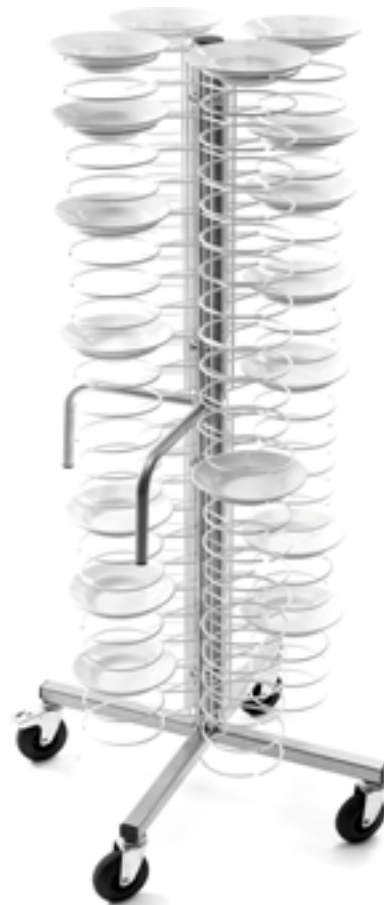

Portata 96 piatti. Griglie verniciate per piatti 18/23
Capacity 96 plates. Polished racks
Capacité 96 plats. Grilles vernies
96 Teller. Lackierte Gitter Tragfähigkeit

CA 1437

€ 460,00

Portata 96 piatti. Griglie cromate per piatti 18/23
Capacity 96 plates. Chromium-plated racks
Capacité 96 plats. Grilles chromées
Tragfähigkeit 96 Teller. Verchromte Roste

CA 1438

€ 480,00

DIMENSIONI ESTERNE - EXTERNAL DIMENSIONS LxPxH cm
DIMENSIONS EXTERIEURES - AUßENABMESSUNGEN LxPxH cm

60x60x173 h

Portata 96 piatti. Griglie verniciate per piatti 25-31
Capacity 96 plates. Polished racks
Capacité 96 plats. Grilles vernies
Tragfähigkeit 96 Teller. Lackierte Gitter

CA 1437 G

€ 490,00

Portata 96 piatti. Griglie cromate per piatti 25-31
Capacity 96 plates. Chromium-plated racks
Capacité 96 plats. Grilles chromées
Tragfähigkeit 96 Teller. Verchromte Roste

CA 1438 G

€ 520,00

DIMENSIONI ESTERNE - EXTERNAL DIMENSIONS LxPxH cm
DIMENSIONS EXTERIEURES - AUßENABMESSUNGEN LxPxH cm

70x70x173 h



ATTENZIONE!
CONFEZIONAMENTO IN KIT
PER RISPARMIO COSTI TRASPORTO

ATTENTION!
PACKING IN SET FOR SAVING
TRANSPORT CHARGES

ATTENTION!
EMBALLAGE EN KIT POUR SAUVER
FRAIS D'EXPEDITION

ACHTUNG!
VERPACKUNG IN KIT UM
VERSANDKOSTEN ZU SPAREN

Carrelli portapiatti, vassoi e teglie - Dish, tray and pan carts - Chariot porte-assiettes, plateaux et plaques - Geschirrwagen, Tablett und Auflaufformen Tellerwagen.

 **CARRELLO PORTAPIATTI ARMADIATO.** Struttura portante in acciaio plastificato. Telaio in alluminio anodizzato. Pannellatura in PERFEX con n. 4 sportelli apribili in plexiglass. Griglie portapiatti in acciaio plastificato rilsan o cromate. Maniglie laterali per conduzione carrello. Ruote Ø 125 di cui due con freno.



Portata 96 piatti. Griglie verniciate per piatti 18/23
Capacity 96 plates. Polished racks
Capacité 96 plats. Grilles vernies
Tragfähigkeit 96 Teller. Lackierte Gitter

CA 1439 A

€ 1.350,00

Portata 96 piatti. Griglie cromate per piatti 18/23
Capacity 96 plates. Chromium-plated racks
Capacité 96 plats. Grilles chromées
Tragfähigkeit 96 Teller. Verchromte Roste

CA 1440 A

€ 1.370,00

Portata 92 piatti. Griglie verniciate per piatti 25/31
Capacity 92 plates. Polished racks for dishes 25/31
Capacité 92 plats. Grilles vernies pour assiettes 25/31
Tragfähigkeit 92 Teller. Lackierte Gitter für Teller 25/31

CA 1439 AG

€ 1.380,00

Portata 92 piatti. Griglie cromate per piatti 25/31
Capacity 92 plates. Chromium-plated racks for dishes 25/31
Capacité 92 plats. Grilles chromées pour assiettes 25/31
Tragfähigkeit 92 Teller. Verchromte Roste für Teller 25/31

CA 1440 AG

€ 1.420,00

DIMENSIONI ESTERNE - EXTERNAL DIMENSIONS LxPxH cm
DIMENSIONS EXTERIEURES - AUBENABMESSUNGEN LxPxH cm

75x78x183 h

 **DISH CARTS WITH CABINET.** Supporting structure in plastic-coated steel. Frame in anodized aluminium. PERFEX panelling with 4 opening doors in plexiglass. Plate racks in rilsan plastic-coated or chromed steel. Side handles to steer trolley. Wheels diam. 125, two with brake.

 **CHARIOTS PORTE-ASSIETTES AVEC ARMOIRE.** Structure portante en acier plastifié. Châssis en aluminium anodisé. Panneaux en PERFEX avec 4 portes ouvrables en plexiglass. Grilles porte-assiettes en acier plastifié Rilsan au chromées. Poignées latérales de conduite du chariot. Roulettes Ø 125 dont deux à frein.

 **SCHRANKWAGEN FÜR GESCHIRR.** Tragende Struktur aus plastifiziertem Stahl. Gestell aus eloxiertem Aluminium. Verschalung aus PERFEX mit 4 Türen aus Plexiglass. Tellerroste aus Rilsanplastifiziertem oder verchromten Stahl. Seitliche Griffe zum Fahren des Wagens. Räder Ø 125, zwei davon mit Bremse.



Porta piatti con 10 Griglie verniciate GN 2/1
Plate holder with 10 painted grids GN 2/1
Porte assiettes avec 10 grilles peintes GN 2/1
Tellerträger mit 10 lackierten Gittern GN 2/1

CG 1439 A

€ 1.570,00

DIMENSIONI ESTERNE - EXTERNAL DIMENSIONS LxPxH cm
DIMENSIONS EXTERIEURES - AUBENABMESSUNGEN LxPxH cm

75x78x170 h

Carrelli portapiatti, vassoi e teglie - Dish, tray and pan carts - Chariot porte-assiettes, plateaux et plaques - Geschirrwagen, Tablett und Auflaufformen Tellerwagen.

 **CARRELLO PORTAPIATTI ANTIPASTI RISCALDATO A RESISTENZA W1600 230V. TERMOSTATO REGOLABILE 30/60°C.** Struttura portante in acciaio plastificato. Telaio in alluminio anodizzato. Pannellatura in PERFEX con n. 4 sportelli apribili in plexiglass. Griglie portapiatti in acciaio cromato. Maniglie laterali per conduzione carrello. Ruote Ø 125 di cui due con freno.

 **HEATED TROLLEY FOR HORS D'OEUVRE DISHES WITH HEATING ELEMENT W1600 V 230. ADJUSTABLE THERMOSTAT 30/60°C.** Supporting structure in plastic-coated steel. Frame in anodized aluminium. PERFEX panelling with 4 opening doors in plexiglass. Plate racks in chromed steel. Side handles to steer trolley. Wheels diam. 125, two with brake.



W 800 + W 800 Portata 88 piatti. Griglie cromate per piatti 18/23
Capacity 88 plates. Polished racks
Capacité 88 plats. Grilles vernies
Tragfähigkeit 88 Teller. Lackierte Gitter

CA 1440 AC

€ 2.000,00

W 800 + W 800 Portata 84 piatti. Griglie cromate per piatti 25/31
Capacity 84 plates. Chromium plated racks for dishes 25/31
Capacité 84 plats. Grilles chromées pour assiettes 25/31
Tragfähigkeit 84 Teller. Verchromte Roste für Teller 25/31

CA 1440 ACG

€ 2.060,00

DIMENSIONI ESTERNE - EXTERNAL DIMENSIONS LxPxH cm
DIMENSIONS EXTERIEURES - AUßENABMESSUNGEN LxPxH cm

75x78x177 h

 **CHARIOT PORTE-ASSIETTES POUR HORS D'OEUVRE CHAUFFÉ AVEC RÉSISTANCE W1600 V 230. THÉRMOSTAT RÉGLABLE 30/60°C.** Structure portante en acier plastifié. Châssis en aluminium anodisé. Panneaux en PERFEX avec 4 portes ouvrantes en plexiglass. Grilles porte-assiettes en acier chromées. Poignées latérales de conduite du chariot. Roulettes Ø 125 dont deux à frein.

 **ERWAERMTER TELLERHALTERWAGEN FÜR VORSPEISETELLER MIT THERMOELEMENT W1600 V 230. REGULIERBARES THERMOSTAT 30/60°C.** Tragende Struktur aus plastifiziertem Stahl. Gestell aus eloxiertem Aluminium. Verschalung aus PERFEX mit 4 Türen aus Plexiglass. Tellerroste aus verchromtem Stahl. Seitliche Griffe zum Fahren des Wagens. Räder Ø 125, zwei davon mit Bremse.



Porta piatti riscaldato con 10 Griglie verniciate GN 2/1
Warmed plate holder with 10 painted grids GN 2/1
Porte assiettes chauffé avec 10 grilles peintes GN 2/1
Erwärmter Tellerträger mit 10 lackierten Gittern GN 2/1

CG 1439 AC

€ 2.250,00

DIMENSIONI ESTERNE - EXTERNAL DIMENSIONS LxPxH cm
DIMENSIONS EXTERIEURES - AUßENABMESSUNGEN LxPxH cm

75x78x177 h

Carrelli portapiatti, vassoi e teglie - Dish, tray and pan carts - Chariot porte-assiettes, plateaux et plaques - Geschirrwagen, Tablett und Auflaufformen Tellerwagen.

 **CARRELLO PORTAPIATTI ANTIPASTI REFRIGERATO A VENTILAZIONE +8° +12°C MANTENIMENTO TEMPORANEO PER PIATTI DIAM. 18-31.** Struttura portante in acciaio plastificato. Telaio in alluminio anodizzato. Pannellatura in isomac sp. 25 mm con n. 4 sportelli apribili in PLX. Griglie portapiatti in acciaio plastificato rilsan. Maniglie laterali per conduzione carrello. Ruote Ø 125 di cui due con freno.

 **VENTILATED REFRIGERATION TROLLEY +8° +12°C FOR HORS D'OEUVRES DISHE DIAM. 18-31 TEMPORARY KEEPING OF TEMPERATURE.** Supporting structure in plastic-coated steel. Frame in anodized aluminium. Isomac 25 mm thick panelling with 4 opening doors in plexiglass. Plate racks in rilsan plastic-coated steel. Side handles to steer trolley. Wheels diam. 125, two with brake.

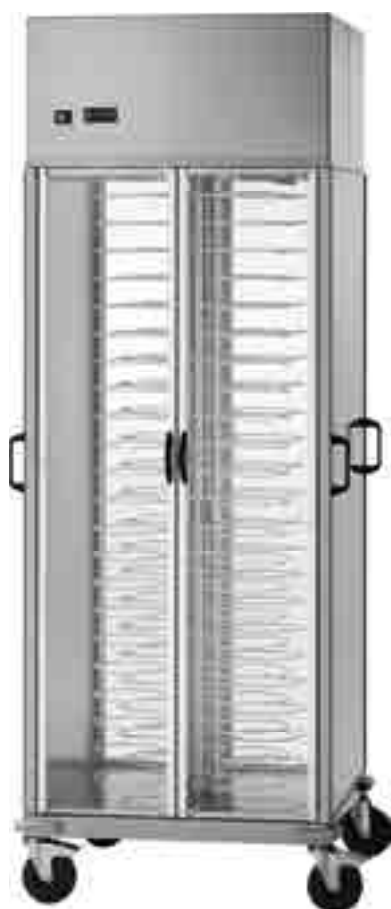

Portata 88 piatti. Griglie verniciate per piatti 18/23
Capacity 88 plates. Polished racks
Capacité 88 plats. Grilles vernies
Tragfähigkeit 88 Teller. Lackierte Gitter

CA 1439 R

€ 2.350,00

Portata 88 piatti. Griglie verniciate per piatti 25/31
Capacity 88 plates. Polished racks for dishes 25/31
Capacité 88 plats. Grilles vernies pour assiettes 25/31
Tragfähigkeit 88 Teller. Lackierte Gitter für Teller 25/31

CA 1439 RG

€ 2.400,00

DIMENSIONI ESTERNE - EXTERNAL DIMENSIONS LxPxH cm
DIMENSIONS EXTERIEURES - AUßENABMESSUNGEN LxPxH cm

75x78x203 h

 **CHARIOT PORTE-ASSIETTES POUR HORS D'OEUVRE REFRIGÉRÉ À VENTILATION +8° +12°C MAINTIEN TEMPORAIRE POUR ASSIETTES DIAM. 18-31.** Structure portante en acier plastifié. Châssis en aluminium anodisé. Panneaux en isomac épais 25 mm avec 4 portes ouvrantes en plexiglass. Grilles porte-assiettes en acier plastifié rilsan. Poignées latérales de conduite du chariot. Roulettes Ø 125 dont deux à frein.

 **GEKÜHLTER TELLERWAGEN FÜR VORSPEISETELLER MIT LÜFTUNG +8° +12°C ZEITWEILIGE ERHALTUNG FÜR TELLER DURCH. 18-31.** Tragende Struktur aus plastifiziertem Stahl. Gestell aus eloxiertem Aluminium. Verschalung aus isomac 25 mm Dick mit 4 Türen aus Plexiglas. Tellerroste aus Rilsanplastifiziertem. Seitliche Griffe zum Fahren des Wagens. Räder Ø 125, zwei davon mit Bremse.

Alimentazione - Power supply - Branchement - Anschluss	230V~ 50Hz
Potenza elettrica - Electrical power - Puissance électrique - Leistung	460W
Potenza frigorifera - Refrigerating power - Puissance frigorifère - Kalteleistung	510W 440Kcal/h
Refrigerante ecologico - Environment-friendly refrigerant - Refrigerant - Kaltemittel	R 134 a



Porta piatti refrigerato con 10 Griglie verniciate GN 2/1
Refrigerated plate holder with 10 painted grids GN 2/1
Porte assiettes réfrigéré avec 10 grilles peintes GN 2/1
Gekühlter Tellerträger mit 10 lackierten Gittern GN 2/1

CG 1439 R

€ 2.650,00

DIMENSIONI ESTERNE - EXTERNAL DIMENSIONS LxPxH cm
DIMENSIONS EXTERIEURES - AUßENABMESSUNGEN LxPxH cm

75x78x203 h

Carrelli portapiatti, vassoi e teglie - Dish, tray and pan carts - Chariot porte-assiettes, plateaux et plaques - Geschirrwagen, Tablett und Auflaufformen Tellerwagen.

 **CARRELLO PORTAPIATTI.** Struttura in tubo di acciaio inox. Ripiano portapiatti e pannellatura in lamiera di acciaio inox. Ruote piroettanti. Portata 200 piatti circa.

 **DISH TROLLEY.** Stainless steel tube frame. Bottom shelf and panneling in stainless steel. Swivelling wheels. Capacity 200 plates approx.

 **CHARIOTS PORTE-ASSIETTES.** Châssis porteur en tube d'acier inox. Porte-assiettes et panneaux en acier inox. Roues pivotantes. Portée d'environ 200 assiettes.

 **GESCHIRRWAGEN.** Gestell aus rostfreiem Stahlrohr. Tellerhalterplatte und Täfelung aus rostfreiem Stahlaminat. Pirouttierende Rollen. Tragfähigkeit ca. 200 Teller.



CP 1441

€ 370,00

DIMENSIONI ESTERNE - EXTERNAL DIMENSIONS LxPxH cm
DIMENSIONS EXTERIEURES - AUßENABMESSUNGEN LxPxH cm

91x57x101 h



Con piano superiore inox / With stainless steel upper shelf
Avec étage supérieur en acier inox / Mit oberer Etage aus rostfreiem Stahl

CP 1441 C

€ 420,00

DIMENSIONI ESTERNE - EXTERNAL DIMENSIONS LxPxH cm
DIMENSIONS EXTERIEURES - AUßENABMESSUNGEN LxPxH cm

91x57x101 h



Optionals

A 512 Ruote con freno - Wheels with catch - Roues avec frein - Räder mit Bremse **€ 7,00 cad./each**

A 1001 Cestino piccolo - Small basket - Petit panier - Klein Korb (per/for CP 1441 - 1441C) **€ 10,00**

A 1002 Cestino grande - Big basket - Grand panier - Gros Korb (per/for CP 1441 - 1441C) **€ 22,00**

Carrelli portapiatti, vassoi e teglie - Dish, tray and pan carts - Chariot porte-assiettes, plateaux et plaques - Geschirrwagen, Tablett und Auflaufformen Tellerwagen.

 Carrelli per ritiro, distribuzione e stoccaggio vassoi, piatti, tazze, ecc. Telaio in acciaio inox. Cesti asportabili in filo di acciaio plastificato. Ruote pivotanti Ø mm 120. Paracolpi.

 Trays, dishes, cups stacking and distribution trolleys. Stainless steel framework. Detachable basket in plastic coated steel wire. Full swivelling castors Ø mm 120. Bumpers.

 Chariots pour distribution et rangement de plateaux, assiettes et tasses. Châssis en acier inox. Panier amovible en fil d'acier plastifié. Roulettes pivotantes Ø mm 120. Parechocs.

 Wagen für Abdecken, Verteilung und Lagerung der Servierbretter, Teller ecc. Struktur aus Edelstahl. Korb aus plastifiziertem Stahl. Lankräder Ø 120 mm. Stossfänger.



Un cesto, portata 100 piatti
One basket. Capacity 100 dishes
Un panier. Capacité 100 assiettes
Ein Korb. Tragfähigkeit 100 Teller

CA 656

€ 320,00

DIMENSIONI ESTERNE - EXTERNAL DIMENSIONS LxPxH cm
DIMENSIONS EXTERIEURES - AUßENABMESSUNGEN LxPxH cm

88x50x92 h



Portata 130 vassoi
Capacity approx 130 trays
Capacité 130 plateaux environ
Tragfähigkeit 130 Tabletten

CA 631

€ 270,00

DIMENSIONI ESTERNE - EXTERNAL DIMENSIONS LxPxH cm
DIMENSIONS EXTERIEURES - AUßENABMESSUNGEN LxPxH cm

75x65x92 h



Due cesti, portata 200 piatti
Two baskets. Capacity 200 dishes
Due paniers. Capacité 200 assiettes
Zwei Körbe. Tragfähigkeit 200 Teller

CA 659

€ 500,00

DIMENSIONI ESTERNE - EXTERNAL DIMENSIONS LxPxH cm
DIMENSIONS EXTERIEURES - AUßENABMESSUNGEN LxPxH cm

88x105x98 h

Optionals

A 512

Ruote con freno - Wheels with catch - Roues avec frein - Räder mit Bremse

€ 7,00 cad./each

Carrello scolapiatti-bicchieri - Dish and glass drying rack trolley

Chariot égouttoir à vaisselle - verres - Abtropfwagen für Geschirr und Gläser

-  Struttura in acciaio sabbiato EPOSS. Elementi portapiatti in plastica fusa. Vasca raccogli condensa in polistirolo antiurto. Cestelli portabicchieri, posate, ecc. in filo di acciaio plastificato. Ruote pivotanti Ø mm 120. Paracolpi.
-  Enamel coated steel framework. Moulded plastic dish-racks. Dipping pan in stockresistant polystyrene. Glass and cutlery baskets, in plastic coated steel wire. Full swivelling castors Ø mms 120. Bumpers.
-  Châssis en acier sablé. Porte-assiettes en plastique. Cuve ramasse-gouttles en polystireneparechocs. Paniers pour les verres et les couverts en fil d'acier plastifié. Roulettes pivotantes Ø 120 mm. Parechocs.
-  Struktur aus EPOSS - Stahl. Tellerhalter aus Kunststoff. Tropfenauffangschale aus stossfester Polystiren. Körbe für Gläser und besteck aus plastifiziertem Stahldraht. Lankräder Ø 120 mm. Stossfänger.
-  Struttura in acciaio sabbiato EPOSS. Vasca raccogli condensa in lamiera INOX. Quattro elementi asportabili portapiatti e due portabicchieri. Portata 100 piatti. Ruote pivotanti Ø mm 100. Cestelli supplementaria richiesta.
-  Enamel coated steel frameworks. Dripping pan in stainless steel sheet. Four detachable dish-racks and two glass racks. Capacity 100 dishes. Full swivelling castors Ø mms 100. Extra racks available on request.
-  Châssis en acier sablé. Cuve ramasse-gouttles en feuille d'acier inox. Quatre porteassiettes amovibles et deux paniers pour les verres. capacité 100 assiettes. Roulettes pivotantes Ø mm 100. Paniers supplémentaires disponible sur demande.
-  Struktur aus EPOSS-Stahl. Tropfenauffangeschale aus Edelstahl Blättern. Vier aufziehbare Tellerhalter, zwei Körbe für Gläser. Tragfähigkeit 100. Drehräder ø 100 mm. Zusätzliche Körbe auf Anfrage.



Portata 300 piatti - Capacity 300 dishes.
Capacité 300 assiettes - Tragfähigkeit 300 Teller.

CA 602

€ 1.050,00

Portata 200 piatti. Due cestelli portabicchieri.
Capacity 200 dishes. Two glass racks.
Capacité 200 assiettes. Deux paniers pour les verres.
Tragfähigkeit 200 Teller. Zwei Körbe für Gläser.

CA 603

€ 1.080,00

Sei cestelli portabicchieri - Six glass racks
Six paniers pour les verres - Sechs Körbe für Gläser

CA 604

€ 1.180,00

DIMENSIONI ESTERNE - EXTERNAL DIMENSIONS LxPxH cm
DIMENSIONS EXTERIEURES - AUßENABMESSUNGEN LxPxH cm

117x62x110 h



CA 609

€ 600,00

DIMENSIONI ESTERNE - EXTERNAL DIMENSIONS LxPxH cm
DIMENSIONS EXTERIEURES - AUßENABMESSUNGEN LxPxH cm

80x60x105 h

Scolapiatti e bicchieri da muro - Dish and glass drying racks on wall Egouttier pour assiettes et verres à mur - Abtropfwagen für Geschirr und Gläser für Wand

 Telaio in tubo di acciaio inox. Ripiani con griglie in acciaio inox per piatti. Vaschette scola bicchieri in acciaio inox. Piano raccogli gocce in acciaio inox. Ruote piroettanti.

 Frame in tubular stainless steel. Stainless steel racks for plates. Stainless steel glass draining tray. Stainless steel drip tray. Swivelling wheels.

 Châssis tubulaire en acier inox. Etagères à grilles en acier inox pour assiettes. Bac égouttoir à verres en acier inox. Cuvette d'égouttage en acier inox. Roulettes pivotantes.

 Gestell aus Niro-Stahl-Rohr. Roste aus Niro-Stahl für Teller. Gläser-Abtropfwanne aus Niro-Stahl. Tropfenauffang-Fläche aus Niro-Stahl. Drehräder.



3 piani scolapiatti.
3 shelves dish draining trolley.
Chariot-égouttoir pour assiettes. 3 etages.
Abtropfwagen für Teller. 3 Etagen.

CA 1399 € 495,00

DIMENSIONI ESTERNE - EXTERNAL DIMENSIONS LxPxH cm **110x62x134 h**
DIMENSIONS EXTERIEURES - AUßENABMESSUNGEN LxPxH cm

1 piano scolabicchieri 2 piani scolapiatti.
2 shelves dish and 1 shelve glass draining trolley.
Chariot-égouttoir: 1 rayon pour verres et 2 rayons pour assiettes.
Abtropfwagen: 1 Etage für Gläser und 2 Etagen für Teller.

CA 1400 € 560,00

DIMENSIONI ESTERNE - EXTERNAL DIMENSIONS LxPxH cm **110x62x134 h**
DIMENSIONS EXTERIEURES - AUßENABMESSUNGEN LxPxH cm

4 piani scolapiatti
4 shelves dish draining trolley
Chariot-égouttoir pour assiettes. 4 etages
Abtropfwagen für Teller. 4 Etagen

CA 1401 € 600,00

DIMENSIONI ESTERNE - EXTERNAL DIMENSIONS LxPxH cm **110x62x160 h**
DIMENSIONS EXTERIEURES - AUßENABMESSUNGEN LxPxH cm

 Realizzati in acciaio inox lucido 18/8.

 In 18/8 bright stainless steel.

 Aus rostfreiem Glanzstahl 18/8.

 Réalisé en acier inoxydable 18/8.



SPB 1398 € 70,00

DIMENSIONI ESTERNE - EXTERNAL DIMENSIONS LxPxH cm **80x26x37 h**
DIMENSIONS EXTERIEURES - AUßENABMESSUNGEN LxPxH cm

 Realizzati in acciaio inox lucido 18/8.

 In 18/8 bright stainless steel.

 Aus rostfreiem Glanzstahl 18/8.

 Réalisé en acier inoxydable 18/8.



SP 1397 € 135,00

DIMENSIONI ESTERNE - EXTERNAL DIMENSIONS LxPxH cm **104x30x55 h**
DIMENSIONS EXTERIEURES - AUßENABMESSUNGEN LxPxH cm

Cestelli per lavastoviglie 50x50 - Racks for dishwashing machines
Paniers pour lave-vaisselle - Körbe für Spülmaschine



BVM	base vuota h 90 mm col. grigio per posate	€ 18,00
BV	base vuota h 90 mm col. grigio universale	€ 18,00
B9	base 9 scomparti h 90 mm col. grigio (bicchiere diam. 140 mm)	€ 20,00
B16	base 16 scomparti h 90 mm col. grigio (bicchiere diam. 110 mm)	€ 21,50
B25	base 25 scomparti h 90 mm col. grigio (bicchiere diam. 80 mm)	€ 23,00
B36	base 36 scomparti h 90 mm col. grigio (bicchiere diam. 70 mm)	€ 24,00
B49	base 49 scomparti h 90 mm col. grigio (bicchiere diam. 60 mm)	€ 26,00
BP	base per piatti o vassoi h 90 mm col. grigio	€ 19,00
BA	base per vassoi aperto su un lato h 90 mm col. grigio	€ 20,00
RIAU	rialzo universale h 45 mm col. blu	€ 9,00
RIA9	rialzo 9 scomparti h 45 mm col. blu	€ 10,00
RIA25	rialzo 25 scomparti h 45 mm col. blu	€ 10,00
RIA36	rialzo 36 scomparti h 45 mm col. blu	€ 10,00
RIA49	rialzo 49 scomparti h 45 mm col. blu	€ 11,00
RIA16	rialzo 16 scomparti h 45 mm col. blu	€ 10,00
CP8	cestellino inserto portaposate 8 scomparti	€ 12,00
COPCEST	copertchio standard per cestelli	€ 14,00



Carrello portacestelli inox
 Stainless steel dishwasher trays trolley
 Chariot porte-paniers en acier inox
 Edelstahl Wagen für Spülmaschinekörbchen.

CP 1442





€ 280,00

DIMENSIONI ESTERNE - EXTERNAL DIMENSIONS LxPxH cm
 DIMENSIONS EXTERIEURES - AUßENABMESSUNGEN LxPxH cm

65x65x170 h

Portacestelli per lavastoviglie - Dish washer tray trolley Porte-paniers pour lave-vaisselle - Korbhalter für Spülmaschinen



-  Vasca in ABS. Manico inox.
-  Container in ABS stainless steel handle.
-  Cuve en ABS poignée en acier inox.
-  Behälter aus ABS Handgriff aus Edelstahl.

Con manico - With handle - Avec poignée - Mit handgriff

CP 1447 € 120,00





DIMENSIONI ESTERNE - EXTERNAL DIMENSIONS LxPxH cm **53x56x92 h**
DIMENSIONS EXTERIEURES - AUßENABMESSUNGEN LxPxH cm

Senza manico - Without handle - Sans poignée - Ohne Handgriff

CP 1448 € 85,00

DIMENSIONI ESTERNE - EXTERNAL DIMENSIONS LxPxH cm **53x56x21 h**
DIMENSIONS EXTERIEURES - AUßENABMESSUNGEN LxPxH cm



-  Interamente in acciaio inox.
-  Entirely stainless steel.
-  Entièrement en acier inoxydable.
-  Komplett aus rostfreiem Stahl.

Con manico - With handle - Avec poignée - Mit handgriff

CP 1445 € 200,00





DIMENSIONI ESTERNE - EXTERNAL DIMENSIONS LxPxH cm **52x58x96 h**
DIMENSIONS EXTERIEURES - AUßENABMESSUNGEN LxPxH cm

Senza manico - Without handle - Sans poignée - Ohne Handgriff

CP 1446 € 180,00

DIMENSIONI ESTERNE - EXTERNAL DIMENSIONS LxPxH cm **52x52x20 h**
DIMENSIONS EXTERIEURES - AUßENABMESSUNGEN LxPxH cm



-  Interamente in acciaio inox. Per cassetta impasti pizza 60x40.
-  Entirely stainless steel. For pizza dough container size 60x40.
-  Entièrement en acier inoxydable. Pour récipient pour pâte à pizza dimensions 60x40.
-  Komplett aus rostfreiem Stahl. Für Behälter für Pizzateig Abmessungen 60x40.

Con manico - With handle - Avec poignée - Mit handgriff

CB 1444 € 210,00

DIMENSIONI ESTERNE - EXTERNAL DIMENSIONS LxPxH cm **72x42x96 h**
DIMENSIONS EXTERIEURES - AUßENABMESSUNGEN LxPxH cm

Senza manico - Without handle - Sans poignée - Ohne Handgriff

CB 1443 € 185,00

DIMENSIONI ESTERNE - EXTERNAL DIMENSIONS LxPxH cm **62x42x20 h**
DIMENSIONS EXTERIEURES - AUßENABMESSUNGEN LxPxH cm

Carrelli portabiancheria, pulizia, multiuso 

Carrello strizzatore

Cestone portabiancheria

Cesto pieghevole plastificato

Carrello multiuso cromato

Carrello in plastica

Laundry, cleaning, multipurpose trolley 

Mop Squeezing trolley

Folding laundry trolley

Plastic folding basket

Multiuse trolley

Plastic trolley

Chariots porte-linge, Nettoyage, Multi-usage 

Chariot-essoreuse

Chariot pliable porte-linge

Panier pliant plastifié

Chariot multiservice

Chariot en plastique

Wagen für Wäschereien, Reinigungsbetriebe, Mehrzweck 

Kübel-Wagen



Klappbarer Wagen



Plastifizierter Klappkorb

Verchromter Mehrzwechwagen

Wagen aus Kunststoff

Carrelli portabiancheria, pulizia, multiuso - Laundry, cleaning, multipurpose trolley
Chariots porte-linge, Nettoyage, Multi-usage - Wagen für Wäschereien, Reinigungsbetriebe, Mehrzweck

-  Struttura in acciaio inox. Un sacco in tessuto ignifugo. Piani in laminato. Ruote multidirezionali. Paracolpi in gomma.
-  Stainless steel structure. One sack made of fireproof clothes. Laminated shelves. Multidirectional wheels. Rubber buffer.

-  Structure en acier inoxydable. Un sac en toile ignifuge. Rayons laminés. Roues pivotantes. Butoir en gomme.
-  Gestell aus rostfreiem Stahl mit ein Wäschesack aus feuerfestem Gewebe. Laminat-platten. Leichtlaufende Rollen. Gummipuffer.



Acciaio inox - Stainless steel - Acier inoxydable - Rostfreier Stahl

CA 1501

€ 260,00

DIMENSIONI ESTERNE - EXTERNAL DIMENSIONS LxPxH cm
 DIMENSIONS EXTERIEURES - AUßENABMESSUNGEN LxPxH cm

79x43x129 h

In dotazione N° 1 sacco in tessuto ignifugo
 No. 1 fireproof sack included
 N. 1 sac en tissu ignifuge compris
 Nr. 1 Feuerfestem Sack inbegriffen



Braccio pieghevole - Folding sack-holder
 Porte-sac pliable - Sackträger Klappbar

CA 1505

€ 460,00

Come sopra in wengè - As above in wengé
 Comme ci-dessus en wengé - Wie oben aus Wengé

CA 1505W

€ 460,00

DIMENSIONI ESTERNE LxPxH cm CHIUSO/APERTO
 EXTERNAL DIMENSIONS LxPxH cm CLOSED / OPEN
 DIMENSIONS EXTERIEURES LxPxH cm FERMÉ / OUVERT
 AUßENABMESSUNGEN LxPxH cm GESCHLOSSEN / GEÖFFNET

70/100x50x123 h

Optionals

A 515 Ruote con freno - Wheels with catch - Roues avec frein - Räder mit Bremse

€ 9,00 cad./each

Carrelli portabiancheria, pulizia, multiuso - Laundry, cleaning, multipurpose trolley
Chariots porte-linge, Nettoyage, Multi-usage - Wagen für Wäschereien, Reinigungsbetriebe, Mehrzweck



Braccio pieghevole - Folding sack-holder
 Porte-sac pliable - Sackträger Klappbar

CA 1510

€ 490,00

Come sopra in wengè -As above in wengè
 Comme ci-dessus en wengé -Wie oben aus Wengé

CA 1510W

€ 490,00

DIMENSIONI ESTERNE LxPxH cm	CHIUSO/APERTO	90/143x50x123 h
EXTERNAL DIMENSIONS LxPxH cm	CLOSED /OPEN	
DIMENSIONS EXTERIEURES LxPxH cm	FERMÉ / OUVERT	
AUßENABMESSUNGEN LxPxH cm	GESCHLOSSEN / GEÖFFNET	

In dotazione N° 1 sacco in tessuto ignifugo
 No. 1 fireproof sack included
 N. 1 sac en tissu ignifuge compris
 Nr. 1 Feuerfestem Sack inbegriffen



Braccio pieghevole - Folding sack-holder
 Porte-sac pliable - Sackträger Klappbar

CA 1515

€ 500,00

Come sopra in wengè - As above in wengè
 Comme ci-dessus en wengé - Wie oben aus Wengé

CA 1515W

€ 500,00

DIMENSIONI ESTERNE LxPxH cm	CHIUSO/APERTO	110/143x50x123 h
EXTERNAL DIMENSIONS LxPxH cm	CLOSED /OPEN	
DIMENSIONS EXTERIEURES LxPxH cm	FERMÉ / OUVERT	
AUßENABMESSUNGEN LxPxH cm	GESCHLOSSEN / GEÖFFNET	

Optionals

A 515

Ruote con freno - Wheels with catch - Roues avec frein - Räder mit Bremse

€ 9,00 cad./each

Carrelli portabiancheria, pulizia, multiuso - Laundry, cleaning, multipurpose trolley

Chariots porte-linge, Nettoyage, Multi-usage - Wagen für Wäschereien, Reinigungsbetriebe, Mehrzweck

 Quattro piani. Cassetta superiore portaccessori. Un sacco in tessuto ignifugo. Ruote Ø mm 120. Paracolpi. Portascopa.

 Four shelves. Top tray for toilet articles and cleaning materials. One sack made of fireproof clothes. Castors Ø mms 120. Bumpers. Broom holder.



 Quatre étagères. Bac supérieur pour accessoires de nettoyage. Un sac en toile ignifuge. Roulettes Ø 120 mm. Butoir. Porte balais.

 Vier Abstellflächen. Zubehörabstellfach. Ein Wäschesack aus feuerfestem Gewebe. Lenkräder Ø 120 mm. Stossfänger. Besenhalter.

Bracci pieghevoli, acciaio inox, piani in laminato
Folding sackholders, stainless steel, laminate shelves
Porte-sacs pliables, acier inox, étagères en stratifié
Sackträger Klappbar, Rostfreiem Stahl, Laminatplatten

CA 740

€ 700,00

DIMENSIONI ESTERNE LxPxH cm	CHIUSO/APERTO
EXTERNAL DIMENSIONS LxPxH cm	CLOSED / OPEN
DIMENSIONS EXTERIEURES LxPxH cm	FERMÉ / OUVERT
AUBENABMESSUNGEN LxPxH cm	GESCHLOSSEN / GEÖFFNET

82/152x50x158 h

In dotazione N° 1 sacco in tessuto ignifugo
No. 1 fireproof sack included
N. 1 sac en tissu ignifuge compris
Nr. 1 Feuerfestem Sack inbegriffen



Bracci pieghevoli. Interamente in acciaio inox
Folding sack-holders. Entirely stainless steel
Porte-sacs pliables. Entièrement en acier inox
Sackträger Klappbar. Komplet aus Rostfreiem Stahl

CA 1525

€ 780,00

DIMENSIONI ESTERNE LxPxH cm	CHIUSO/APERTO
EXTERNAL DIMENSIONS LxPxH cm	CLOSED / OPEN
DIMENSIONS EXTERIEURES LxPxH cm	FERMÉ / OUVERT
AUBENABMESSUNGEN LxPxH cm	GESCHLOSSEN / GEÖFFNET

82/152x50x158 h

Optionals

A 515 Ruote con freno - Wheels with catch - Roues avec frein - Räder mit Bremse

€ 9,00 cad./each

Carrelli portabiancheria, pulizia, multiuso - Laundry, cleaning, multipurpose trolley
Chariots porte-linge, Nettoyage, Multi-usage - Wagen für Wäschereien, Reinigungsbetriebe, Mehrzweck



- 🇮🇹 Struttura in lamiera verniciata a polveri epossidiche. 3 piani intermedi regolabili, con 2 porta sacchi, di cui N° 1 sacco ignifugo in dotazione, vaschetta porta detersivi superiore, Ruote piroettanti Ø 140 mm di cui 2 fisse e 2 girevoli.
- 🇬🇧 Structure in metal sheet painted with epoxy paint. 3 adjustable shelves, 2 sack holders, 1 fireproof sack included, upper container for cleaning products. 2 fixed and 2 multidirectional Ø 140 mm. wheels.
- 🇫🇷 Structure en tôle vernie avec peinture époxy. 3 étagères réglables, 2 porte-sacs, 1 sac ignifuge, récipient supérieur pour les détergents, roues de Ø 140 mm: 2 fixes et 2 pivotantes.
- 🇩🇪 Gestell aus Epoxidpulver lackiertem Blech. 3 regulierbare Zwischenplatten, 2 Sacketräger, 1 feuerfester Sack inbegriffen, oberer Behälter für Reinigungsmittel. Rollen Ø 140 mm.: 2 feste und 2 drehbare.

CA 1530

€ 930,00

DIMENSIONI ESTERNE LxPxH cm	CHIUSO/APERTO
EXTERNAL DIMENSIONS LxPxH cm	CLOSED / OPEN
DIMENSIONS EXTERIEURES LxPxH cm	FERMÉ / OUVERT
AUßENABMESSUNGEN LxPxH cm	GESCHLOSSEN / GEÖFFNET

80/153x50x128 h

In dotazione N° 1 sacco in tessuto ignifugo
 No. 1 fireproof sack included
 N. 1 sac en tissu ignifuge compris
 Nr. 1 Feuerfestem Sack inbegriffen

Optionals

A 518





Ruote con freno - Wheels with catch - Roues avec frein - Räder mit Bremse

€ 20,00 cad./each

Carrello rifornimento frigo-bar - Mini bar supply trolley

Chariot pour frigobar - Kühlbar-Bestückungswagen



-  Struttura in lamiera verniciata a polveri epossidiche. 3 piani intermedi regolabili. Vaschetta laterale per la raccolta dei vuoti, asportabile. Ruote piroettanti Ø 140 mm di cui 2 fisse e 2 girevoli.
-  Painted metal structure. 3 intermediate adjustable shelves. Lateral container for empties. Multidirectional Weels Ø 140 mm: 2 fixed and 2 turnable.
-  Structure tôle vernie. 3 rayons intermédiares réglables. Réceptient laterale pour la récolte des verres. Roues pivotantes Ø 140 mm: 2 fixés et 2 tournantes.
-  Gestell aus Bellech mit Epoxydpulverbeschichtung. 3 regulierbare Zwischenplatten. Seitlicher, abnehmbarer Leergut-Behälter. 2 feste und 2 drehbare pirouettierende Roller von Ø 140 mm.

CR 1696

€ 750,00

DIMENSIONI ESTERNE LxPxH cm
EXTERNAL DIMENSIONS LxPxH cm
DIMENSIONS EXTERIEURES LxPxH cm
AUBENABMESSUNGEN LxPxH cm

80x50x118 h







ATTENZIONE! Foto con OPTIONAL / **WARNING!** Photo with EXTRA ACCESSORIES INCLUDED / **ATTENTION!** Photo avec ACCESSOIRES EXTRA / **ACHTUNG!** Foto mit EXTRAUSSTATTUNG

Optionals

A 1001	Cestino piccolo - Small basket - Petit panier - Klein Korb (per/for CP1010)	€ 10,00 cad./each
A 1002	Cestino grande - Big basket - Grand panier - Gros Korb (per/for CP1010)	€ 22,00 cad./each
A 518	Ruote con freno - Wheels with catch - Roues avec frein - Räder mit Bremse	€ 20,00 cad./each

Carrelli portabiancheria, pulizia, multiuso - Laundry, cleaning, multipurpose trolley
Chariots porte-linge, Nettoyage, Multi-usage - Wagen für Wäschereien, Reinigungsbetriebe, Mehrzweck

-  Carrello strizzatore secchio con divisorio e strizzatore completo di struttura di rialzo per prodotti pulizia con ruote.
-  Mop Squeezing trolley with divide and squeezer. Complete with wheeled raised structure for cleaning products.
-  Chariot-essoreuse. Seau avec séparation etessoreuse. Equipé d'une structure serélevée à roulettes pour les produits d'entretien.
-  Kübel-Wagen mit Unterteilung und Ausdrückvorrichtung. Komplet mit erhöhter Struktur für Putzmittel, mit Rädern.







CA 1599

€ 130,00

DIMENSIONI ESTERNE - EXTERNAL DIMENSIONS LxPxH cm
 DIMENSIONS EXTERIEURES - AUßENABMESSUNGEN LxPxH cm

55x27x87 h

-  Carrello strizzatore nylon lt 50 completo di 2 secchi lt 25, impugnatura reversibile, strizzatore plastica, ruote piroettanti Ø 80.
-  Trolley with wringing nylon box lt 50. It comes with 2 buckets lt 25. reversible handle. Plastic wringing box. Multidirectional wheels Ø 80.
-  Chariot avec tordre-torchon en nylon lt 50 2 seaux lt 25. Poignée reversible. Tordretorchon en plastique. Roues pivotentes Ø 80.
-  Nylon-Auswringwagen zu 50 l mit 2 Eimern zu je 25 l, Wendegriff Kunststoffauswringler, pirouettierende Rollen Ø 80.



CA 1604

€ 155,00

DIMENSIONI ESTERNE - EXTERNAL DIMENSIONS LxPxH cm
 DIMENSIONS EXTERIEURES - AUßENABMESSUNGEN LxPxH cm

69x42x85 h



CA 1599E

€ 75,00

DIMENSIONI ESTERNE - EXTERNAL DIMENSIONS LxPxH cm
 DIMENSIONS EXTERIEURES - AUßENABMESSUNGEN LxPxH cm

60x40x92 h



CA 1604E

€ 90,00

DIMENSIONI ESTERNE - EXTERNAL DIMENSIONS LxPxH cm
 DIMENSIONS EXTERIEURES - AUßENABMESSUNGEN LxPxH cm

71x43x93 h

Carrelli portabiancheria, pulizia, multiuso - Laundry, cleaning, multipurpose trolley

Chariots porte-linge, Nettoyage, Multi-usage - Wagen für Wäschereien, Reinigungsbetriebe, Mehrzweck

 Carrello in plastica. Telaio in plastica con ruote Ø 80 mm. Impugnatura ad "U" in plastica. 1 secchio in plastica lt. 28 con divisorio rosso. Strizzatore in plastica a libro senza fondo". DEEP" Manubrio completo di rinforzi, Portasacco lt. 120 in plastica completo di rinforzi e coperchio. Piatto reggisacco. Portasecchi in plastica completo di supporti. 2 secchi in plastica lt. 4. Gancio in plastica portapaletta. Gancio "FLIP" portamanico con rullo in gomma.

 Plastic trolley. Plastic frame with wheels Ø 80 mm. Plastic handle "U" shape. 1 plastic bucket lt. 28 with red divider. Plastic wringing tool with book system without bottom "DEEP". Reinforced handle. Plastic sack holder 120 lt. reinforced and with lid. Sack holder plate. Plastic bucket holder with supports. 2 plastic bucket lt. 4. Plastic hook for shovel. "FLIP" hook handle holder with rubber roller.

 Carrello in plastica. Telaio in plastica con ruote. Strizzatore in plastica con divisorio. Porta sacco con robusto sacco lt. 120 in plastica. attacchi porta utensili.

 Plastic trolley. Plastic frame with wheels. Plastic mop wringer with separator. Sac holder with lt. 120 strong plastic sac. Fittings for tools.



CA 1613

€ 295,00

DIMENSIONI ESTERNE - EXTERNAL DIMENSIONS LxPxH cm
DIMENSIONS EXTERIEURES - AUßENABMESSUNGEN LxPxH cm

107x56x111 h



CA 1606E

€ 190,00

DIMENSIONI ESTERNE - EXTERNAL DIMENSIONS LxPxH cm
DIMENSIONS EXTERIEURES - AUßENABMESSUNGEN LxPxH cm

114x51x98 h

Carrelli portabiancheria, pulizia, multiuso - Laundry, cleaning, multipurpose trolley **Chariots porte-linge, Nettoyage, Multi-usage - Wagen für Wäschereien, Reinigungsbetriebe, Mehrzweck**

- Carrello multiuso completo di reggisacco, secchio plastica Lt.15. Strizzatore, Cassetta plastica media, 2 secchi Lt.4, cestino portabottiglie. Ruote Ø 100, ganci portascopo.
- Multipurpose trolley with sack holder, plastic bucket Lt.15. Wringer, medium size plastic container, 2 buckets capacity Lt.4, bottle rack. Wheels Ø 100, broom hooks.
- Chariot multiservice avec porte-sac, seau en plastique Lt.15. Tordre-torchon, récipient en plastique moyenne, 2 seaux capacité 4 Lt., porte-bouteilles. Roues Ø 100, crochets pour balais.
- Mehrzweckwagen mit Sackträger, Plastikeimer Lt.15. Wringer, mittlere Kunststoffbehälter ,2 Eimer Kapazität Lt.4. Flaschenhalter, Räder Ø 100, Haken für Besen.
- Carrello multiuso completo di reggisacco, 2 secchi plastica Lt.15. Strizzatore, Cassetta plastica media, 4 secchi Lt.4, cestino portabottiglie. Ruote Ø 100, ganci portascopo, vano centrale con cassetto scorrevole.
- Multipurpose trolley with sack holder, 2 plastic buckets Lt.15. Wringer, medium size plastic container, 4 buckets capacity Lt.4, bottle rack. Wheels Ø 100, broom hooks, central space with sliding drawer.
- Chariot multiservice avec porte-sac, 2 seaux en plastique Lt.15. Tordre-torchon, récipient en plastique moyenne ,4 seaux capacité 4 Lt., porte-bouteilles. Roues Ø 100, crochets pour balais, compartiment centrale avec tiroir coulissant.
- Mehrzweckwagen mit Sackträger, 2 Plastikeimer Lt.15. Wringer, mittlere Kunststoffbehälter ,4 Eimer Kapazität Lt.4. Flaschenhalter, Räder Ø 100, Haken für Besen, zentralen Raum mit Schublade.



CA 1614

€ 340,00

DIMENSIONI ESTERNE - EXTERNAL DIMENSIONS LxPxH cm
 DIMENSIONS EXTERIEURES - AUßENABMESSUNGEN LxPxH cm

92x55x124 h



CA 1615

€ 360,00

DIMENSIONI ESTERNE - EXTERNAL DIMENSIONS LxPxH cm
 DIMENSIONS EXTERIEURES - AUßENABMESSUNGEN LxPxH cm

92x68x124 h

Carrelli portabiancheria, pulizia, multiuso - Laundry, cleaning, multipurpose trolley

Chariots porte-linge, Nettoyage, Multi-usage - Wagen für Wäschereien, Reinigungsbetriebe, Mehrzweck

 Carrello multiuso completo di reggisacco, 2 secchi plastica lt.15. Strizzatore, Cassetta plastica media, 4 secchi lt.4, cestino portabottiglie. Ruote Ø 100, ganci portascopo, vano centrale con cassetto scorrevole.

 Multipurpose trolley with sack holder, 2 plastic buckets lt.15. Wringer, medium size plastic container, 4 buckets capacity lt.4, bottle rack. Wheels Ø 100, broom hooks, central space with sliding drawer.

 Chariot multiservice avec porte-sac, 2 seaux en plastique lt.15. Tordre-torchon, récipient en plastique moyenne, 4 seaux capacité 4 lt., porte-bouteilles. Roues Ø 100, crochets pour balais, compartiment centrale avec tiroir coulissant.

 Mehrzweckwagen mit Sackträger, 2 Plastikeimer lt.15. Wringer, mittlere Kunststoffbehälter, 4 Eimer Kapazität lt.4. Flaschenhalter, Räder Ø 100, Haken für Besen, zentralen Raum mit Schublade.





CA 1616

€ 570,00

DIMENSIONI ESTERNE - EXTERNAL DIMENSIONS LxPxH cm
DIMENSIONS EXTERIEURES - AUßENABMESSUNGEN LxPxH cm

133x68x124 h

 Carrello multiuso in plastica -  Plastic multi-service trolley

 Chariot multi-service trolley -  Allzweckplastikwagen



CA 1520

€ 260,00

DIMENSIONI ESTERNE - EXTERNAL DIMENSIONS LxPxH cm
DIMENSIONS EXTERIEURES - AUßENABMESSUNGEN LxPxH cm

150x54x99 h

 Cestone portabiancheria pieghevole con sacco in tela e ruote piroettanti.

 Folding laundry trolley with cloth bag and multidirectional wheels.

 Chariot pliable porte-linge avec sac en toile et roues rotatives.

 Klappbarer Wagen für Wäsche mit Wäschesack aus Gewebe und Drehbare Räder.



CA 3203

€ 200,00

DIMENSIONI ESTERNE - EXTERNAL DIMENSIONS LxPxH cm
DIMENSIONS EXTERIEURES - AUßENABMESSUNGEN LxPxH cm

62x64x100 h

Sacco per CA 3203 - Sack for CA 3203 - Sac pour CA 3203 - Sack für CA 3203

A 525

€ 45,00

Carrelli portabiancheria, pulizia, multiuso - Laundry, cleaning, multipurpose trolley
Chariots porte-linge, Nettoyage, Multi-usage - Wagen für Wäschereien, Reinigungsbetriebe, Mehrzweck

 Cesto pieghevole plastificato. Struttura in tubo e tondino di acciaio elettroverniciato. Ruote piroettanti.

 Plastic folding basket. White plasticized steel plate net container.

 Panier pliant plastifié. Conteneur pliable portelinge a grillage plastifié.

 Plastifizierter Klappkorb. Gestell aus elektrolakiertem Stahl.



CA 1580

€ 94,00

DIMENSIONI ESTERNE - EXTERNAL DIMENSIONS LxPxH cm
 DIMENSIONS EXTERIEURES - AUßENABMESSUNGEN LxPxH cm

80x52x72 h



CA 1588

€ 155,00

DIMENSIONI ESTERNE - EXTERNAL DIMENSIONS LxPxH cm
 DIMENSIONS EXTERIEURES - AUßENABMESSUNGEN LxPxH cm

100x60x80 h

CA 1584

€ 225,00

DIMENSIONI ESTERNE - EXTERNAL DIMENSIONS LxPxH cm
 DIMENSIONS EXTERIEURES - AUßENABMESSUNGEN LxPxH cm

100x60x87 h

Sacco per CA 1584/1588 - Sack for CA 1584/1588
 Sac pour CA 1584/1588 - Sack für CA 1584/1588

A 531

€ 72,00

Sacco per CA 1580 - Sack for CA 1580
 Sac pour CA 1580 - Sack für CA 1580

A 521

€ 68,00



Carrelli breakfast su ruote 
Carrelli portavalige e portabiti
Reggivalige
Aste delimita-corsie
Macchina pulisci-scarpe
Carrelli da trasporto pesante



Breakfast trolley on wheels 
Luggage and Clothing stands
Luggage rack
Lane poles
Shoeshine machine
Heavy load trolley

Chariots Petit-déjeuner sur roues 
Chariots porte-valises et porte-habits
Porte-valises
Tige de délimitation de passage
Machine nettoyeuse de chaussures
Chariots de transport pesant

Frühstückswagen auf Rädern 
Kofferwagen und Kleiderständerwagen
Kofferhalter
Bahnabgrenzungstangen
Apparat zum Schuhe putzen
Schwere Transportwagen

Carrelli breakfast su ruote - Breakfast trolley on wheels Chariots Petit-déjeuner sur roues - Frühstückswagen auf Rädern

-  Struttura portante in tubo di acciaio inox. Ripiano con antine ribaltabili, in legno rivestito in laminato color noce con bordo in gomma. Ripiano di servizio ruotabile sino a 90°, con possibilità di incastrare i carrelli uno dentro l'altro per ridurre al minimo l'ingombro. Ruote piroettanti (2 con freno).
-  Chromium plated steel tube frame. Shelf with rersible support, covered with laminated plastic brown and rubber lag. The service shelf may be turned up to 90°, thus making it possible to pile up trolleys one into the other, so as to reduce occupied space to a minimum. Swivelling wheels. Two wheels to brake.

-  Châssis porteur en tube d'acier chromé. Table avec antes à abat-tant, en bois revêtu de laminé plastique marron avec bord en caoutchouc. Le plain de dessert peut être auvert jusqu'à 90° avec la possibilité d'enclaver les chariots l'un dans l'autre pour réduire l'encombrement au minimum. Roues pivotantes. Deux avec frein.
-  Gestell aus verchromtem Stahlrohr. Holzplatte mit kippbaren Flügeln, mit nußbaumfarbigem Laminat Verkleidet und Gummikante. Bis zu 90° drehbare Servierplatte; die Wagen können zur Platzeinsparnis ineinandergesteckt werden. Pirouettierende Rollen, 2 mit Bremse.



CB 980 € 390,00

CB 980W € 390,00

DIMENSIONI ESTERNE LxPxH cm
EXTERNAL DIMENSIONS LxPxH cm
DIMENSIONS EXTERIEURES LxPxH cm
AUBENABMESSUNGEN LxPxH cm

OPEN Ø80x80 h
CLOSED 80x53x80 h

CB 970 € 390,00

CB 970W € 390,00

DIMENSIONI ESTERNE LxPxH cm
EXTERNAL DIMENSIONS LxPxH cm
DIMENSIONS EXTERIEURES LxPxH cm
AUBENABMESSUNGEN LxPxH cm

OPEN 80x80x80 h
CLOSED 80x53x80 h



Carrelli breakfast su ruote - Breakfast trolley on wheels Chariots Petit-déjeuner sur roues - Frühstückswagen auf Rädern

 CASSETTA TERMICA SCALDAPIATTI PER CARRELLI BREAKFAST. Costruita interamente in acciaio inox. Resistenza elettrica W 250 - V 230. Termostato regolabile 0°-90°.

 PLATE WARMING THERMAL CASE FOR BREAKFAST TROLLEY. Entirely stainless steel. Electric resistance W 250 V 230. Adjustable thermostat 0°-90°.

 BOÎTIER THERMIQUE CHAUFFE-PLATS POUR CHARIOTS PETIT-DÉJEUNER. Entièrement en acier inoxydable. Résistance électrique W 250 V 230. Thermostat réglable 0°-90°.

 THERMOKASTEN ZUM ERWÄRMEN DES GESCHIRRS FÜR FRÜHSTÜCKWAGEN. Komplett aus rostfreiem Stahl. Elektrischer Widerstand: W 250 - 230 V. Regulierbares Thermostat: 0°-90°.





CST 300

€ 360,00

DIMENSIONI ESTERNE LxPxH cm
EXTERNAL DIMENSIONS LxPxH cm
DIMENSIONS EXTERIEURES LxPxH cm
AUBENABMESSUNGEN LxPxH cm

39x37x46 h

 Struttura in tubi acciaio inox da mm 25x25. Con guide per contenere n. 6 cassette termiche. Mod. CST 300 con relative prese elettriche. Assorbimento massimo 1500 W 230 V 50/60Hz. Con ruote Ø125 di cui 2 con freno.

 Stainless steel structure mm 25x25. Runners for no.6 thermal boxes mod.CST300 and their sockets. Maximum absorption 1500 W 230 V 50/60Hz. Wheels Ø 125, 2 of which with brake.

 Structure en acier inox mm 25x25. Glissières pour no.6 boîtes thermiques mod. CST300 et leur prises électriques. Absorption maximale 1500 W 230 V 50/60Hz. Roues Ø 125, dont 2 avec frein.

 Gestell aus rostfreiem Stahl mm 25x25. Schienen fuer Nr. 6 Thermokasten Mod.CST300 und Ihre Steckdosen. Maximale Netzspannung 1500 W 230 V 50/60Hz. Raeder Ø 125, 2 davon mit Bremse.



Carrello porta cassette termiche con presa elettrica

Trolley with socket for thermal boxes

Chariot porte-boîtes thermiques avec prise électrique

Wagen fuer Thermokasten mit Steckdose

CPC 600









€ 400,00

DIMENSIONI ESTERNE LxPxH cm
EXTERNAL DIMENSIONS LxPxH cm
DIMENSIONS EXTERIEURES LxPxH cm
AUBENABMESSUNGEN LxPxH cm

155x61x132 h

Carrelli portavalige e portabiti - Luggage and Clothing stands

Chariots porte-valises et porte-habits - Kofferwagen und Kleiderständerwagen

-  PORTAVALIGE CON APPENDIABITI. Base in legno ricoperta da moquette. Supporto asta in tubolare di acciaio ottonato, sezione Ø mm 40. Bordo paracolpi perimetrale in gomma. Ruote Ø mm 175, piroettanti.
-  LUGGAGE TROLLEY WITH CLOTHING STANDS. Wood base covered with moquette. Bar support made of brass coated tubular steel Ø mm 40. Rubber buffer edge 4 wheels Ø 175 mm multidirectional.
-  PORTE-VALISES AVEC PORTE-MANTEAUX. Base en bois couverte en moquette. Supporte barre tubolaire en acier cuivré Ø 40 mm. Butoir périmétrale en gomme. Roues Ø 175 mm pivotantes.
-  KOFFERWAGEN MIT KLEIDERSTÄNDER. Untergestell aus Holz mit Teppichbodenbelag. Stützstange aus vermessingtem Stahlrohr Ø mm 40. Stoßfester Gummirand. Rollen Ø mm 175, drehbare.
-  PORTAVALIGE CON APPENDIABITI. Base in legno ricoperta da moquette. Supporto asta in tubolare di acciaio cromato, sezione Ø mm 40. Bordo paracolpi perimetrale in gomma. Ruote Ø mm 175, piroettanti.
-  LUGGAGE TROLLEY WITH CLOTHING STANDS. Wood base covered with moquette. Bar support made of chromed tubular steel Ø mm 40. Rubber buffer edge 4 wheels Ø 175 mm multidirectional.
-  PORTE-VALISES AVEC PORTE-MANTEAUX. Base en bois couverte en moquette. Supporte-barre tubolaire en acier chromé Ø 40 mm. Butoir périmétrale en gomme. Roues Ø 175 mm pivotantes.
-  KOFFERWAGEN MIT KLEIDERSTÄNDER. Untergestell aus Holz mit Teppichbodenbelag. Stützstange aus verchromtem Stahlrohr Ø 40 mm. Stoßfester Gummirand. Rollen Ø mm 175, drehbare.



PV 4062

€ 860,00

DIMENSIONI ESTERNE - EXTERNAL DIMENSIONS LxPxH cm
DIMENSIONS EXTERIEURES - AUßENABMESSUNGEN LxPxH cm

95x55x190 h

PV 4064

€ 830,00

DIMENSIONI ESTERNE - EXTERNAL DIMENSIONS LxPxH cm
DIMENSIONS EXTERIEURES - AUßENABMESSUNGEN LxPxH cm

95x55x190 h

Carrelli portavalige e portabiti - Luggage and Clothing stands Chariots porte-valises et porte-habits - Kofferwagen und Kleiderständerwagen

- PORTAVALIGE CON APPENDIABITI. Base in legno ricoperta da moquette. Supporto asta in tubolare di acciaio ottonato, sezione Ø mm 40. Bordo paracolpi perimetrale in gomma. Ruote Ø mm 175, piroettanti.
- LUGGAGE TROLLEY WITH CLOTHING STANDS. Wood base covered with moquette. Bar support made of brass coated tubular steel Ø mm 40. Rubber buffer edge 4 wheels Ø 175 mm multidirectional.
- PORTE-VALISES AVEC PORTE-MANTEAUX. Base en bois couverte en moquette. Supporte-barre tubolaire en acier cuivré Ø 40 mm. Butoir périmétrale en gomme. Roues Ø 175 mm pivotantes.
- KOFFERWAGEN MIT KLEIDERSTÄNDER. Untergestell aus Holz mit Teppichbodenbelag. Stützstange aus vermessingtem Stahlrohr Ø mm 40. Stoßfester Gummirand. Rollen Ø mm 175, drehbare.
- PORTAVALIGE CON APPENDIABITI. Base in legno ricoperta da moquette. Supporto asta in tubolare di acciaio cromato, sezione Ø mm 40. Bordo paracolpi perimetrale in gomma. Ruote Ø mm 175, piroettanti.
- LUGGAGE TROLLEY WITH CLOTHING STANDS. Wood base covered with moquette. Bar support made of chromed tubular steel Ø mm 40. Rubber buffer edge 4 wheels Ø 175 mm multidirectional.
- PORTE-VALISES AVEC PORTE-MANTEAUX. Base en bois couverte en moquette. Supporte barre tubolaire en acier chromé Ø 40 mm. Butoir périmétrale en gomme. Roues Ø 175 mm pivotantes.
- PORTE-VALISES AVEC PORTE-MANTEAUX. Base en bois couverte en moquette. Supporte barre tubolaire en acier chromé Ø 40 mm. Butoir périmétrale en gomme. Roues Ø 175 mm pivotantes.



PV 4055

€ 730,00

DIMENSIONI ESTERNE - EXTERNAL DIMENSIONS LxPxH cm
DIMENSIONS EXTERIEURES - AUßENABMESSUNGEN LxPxH cm

95x55x183 h

PV 4056

€ 670,00

DIMENSIONI ESTERNE - EXTERNAL DIMENSIONS LxPxH cm
DIMENSIONS EXTERIEURES - AUßENABMESSUNGEN LxPxH cm

95x55x183 h

Carrelli portavalige e portabiti - Luggage and Clothing stands

Chariots porte-valises et porte-habits - Kofferwagen und Kleiderständerwagen

 Carrello portavaligie con appendiabiti in acciaio ottonato o acciaio inox con pianale in legno ricoperto di moquette, ruote Ø 200 mm.

 Luggage trolley with brass painted steel clothing stands or stainless steel and with a wooden base covered with moquette. 200 Ø wheels.

 Porte-valises avec porte-manteaux en acier couleur cuivre o acier inox. Base en bois couverte en moquette. Roues Ø 200.

 Kofferwagen mit Kleiderständer aus Vermessingtem Stahl oder Edelstahl mit Boden aus Holz mit Teppichbodenbelag. Rollen Ø 200 mm.



PV 2001 (ottonato)

€ 900,00

DIMENSIONI ESTERNE - EXTERNAL DIMENSIONS LxPxH cm
DIMENSIONS EXTERIEURES - AUßENABMESSUNGEN LxPxH cm

124x64x190 h

PV 2001I (inox)

€ 840,00



DIMENSIONI ESTERNE - EXTERNAL DIMENSIONS LxPxH cm
DIMENSIONS EXTERIEURES - AUßENABMESSUNGEN LxPxH cm

124x64x190 h

**IL CARRELLO VIENE SPEDITO IN KIT SMONTATO - THE TROLLEY IS DELIVERED DISMOUNTED
LE CHEROIT EST LIVRÉ DEMONTÉ - DER WAGEN IST DEMONTIERT GELIEFERT**

Carrelli portavaligie e portabiti - Luggage and Clothing stands **Chariots porte-valises et porte-habits - Kofferwagen und Kleiderständerwagen**

-  Carrello portavaligie con appendiabiti in acciaio ottonato o acciaio inox con pianale in legno ricoperto di moquette, ruote Ø 200mm pneumatiche.

 Luggage trolley with brass painted steel clothing stands or stainless steel and with a wooden base covered with moquette. 200 Ø pneumatic wheels.
-  Porte-valises avec porte-manteaux en acier couleur cuivre o acier inox. Base en bois couverte en moquette. Roues pneumatiques Ø 200.

 Kofferwagen mit Kleiderständer aus Vermessingtem Stahl oder Edelstahl mit Boden aus Holz mit Teppichbodenbelag. Pneumatische Rollen Ø 200 mm.



PV 2021 (ottonato)

€ 980,00

DIMENSIONI ESTERNE - EXTERNAL DIMENSIONS LxPxH cm
DIMENSIONS EXTERIEURES - AUBENABMESSUNGEN LxPxH cm

110x62x198 h

PV 2021 I (inox)

€ 920,00

DIMENSIONI ESTERNE - EXTERNAL DIMENSIONS LxPxH cm
DIMENSIONS EXTERIEURES - AUBENABMESSUNGEN LxPxH cm

110x62x198 h

IL CARRELLO VIENE SPEDITO IN KIT SMONTATO - THE TROLLEY IS DELIVERED DISMOUNTED
LE CHEROIT EST LIVRÉ DEMONTÉ - DER WAGEN IST DEMONTIERT GELIEFERT

Carrelli portavaligie e portabiti - Luggage and Clothing stands

Chariots porte-valises et porte-habits - Kofferwagen und Kleiderständerwagen

 Carrello portavaligie in acciaio ottonato o inox a due ruote dia. 250 con piedi di appoggio base pieghevole pianali in legno ricoperti di moquette.

 Two 250 Ø wheels luggage trolley in brass painted steel or stainless steel equipped with support feet, folding base and wooden surfaces covered with moquette.

 Chariot porte-valises à deux roues Ø 250 en acier couleur cuivre ou inox. Pieds d'appui, base pliable et surfaces en bois couvertes en moquette.

 Kofferwagen aus Vermessingtem Stahl oder Edelstahl mit zwei Rollen Ø 250 mm mit Unterstützungfüsse, Klappbarem Boden und Oberfläche aus Holz mit Teppichbelag.

 Carrello portavaligie in acciaio ottonato o inox a due ruote Ø 250 con base pieghevole pianali in legno ricoperti di moquette.

 Two 250 Ø wheels luggage trolley in brass painted steel or stainless steel. Equipped with folding base and wooden surfaces covered with moquette.

 Chariot porte-valises à deux roues Ø 250 en acier couleur cuivre ou inox. Base pliable et surfaces en bois couvertes en moquette.

 Kofferwagen aus Vermessingtem Stahl oder Edelstahl mit zwei Rollen Ø 250 mm, Klappbarem Boden und Oberfläche aus Holz mit Teppichbelag.



PV 2002 (ottonato)

€ 260,00

DIMENSIONI ESTERNE - EXTERNAL DIMENSIONS LxPxH cm
DIMENSIONS EXTERIEURES - AUßENABMESSUNGEN LxPxH cm

56x83x123 h



PV 2003 (ottonato)

€ 220,00

DIMENSIONI ESTERNE - EXTERNAL DIMENSIONS LxPxH cm
DIMENSIONS EXTERIEURES - AUßENABMESSUNGEN LxPxH cm

56x70x120 h



PV 2002 I (inox)

€ 230,00

DIMENSIONI ESTERNE - EXTERNAL DIMENSIONS LxPxH cm
DIMENSIONS EXTERIEURES - AUßENABMESSUNGEN LxPxH cm

56x83x123 h







PV 2003 I (inox)

€ 185,00

DIMENSIONI ESTERNE - EXTERNAL DIMENSIONS LxPxH cm
DIMENSIONS EXTERIEURES - AUßENABMESSUNGEN LxPxH cm

56x70x120 h

Carrelli da trasporto pesante - Heavy load trolley Chariots de transport pesant - Schwere Transportwagen

-  **CARRELLO PORTAVALIGE.** Struttura in acciaio verniciato. Piano inferiore rivestito in moquette. Ruote Ø mm 200. Due pivottanti e due fisse.
-  **LUGGAGE TROLLEY.** Painted steel framework. Lower shelf fitted with moquette lining. Wheels Ø mms 200, two fixed and two castors.
-  **CHARIOT PORTE-BAGAGES.** Châssis en acier verni. Etagère inférieure revêtue de moquette. Roues Ø mms 200, dant deux fixes et deux pivotantes.
-  **GEPÄCKWAGEN.** Struktur aus Lackiertem Stahl. Unterabstellfläche mit Moquettebelag verkleidet. Räder Ø 200 mm, davon 2 feste und 2 lenkbar.







PV 748

€ 500,00

DIMENSIONI ESTERNE - EXTERNAL DIMENSIONS LxPxH cm
DIMENSIONS EXTERIEURES - AUBENABMESSUNGEN LxPxH cm

143x70x102 h

-  **CARRELLO PORTACASSE.** Struttura in tubo di acciaio verniciato a polveri epossidiche. Ruote Ø 200 pneumatiche. Portata kg 200.
-  **BOX TROLLEY.** Enamel coated steel frame. Wheels Ø 200. Loads Kg 200.
-  **CHARIOT PORTE-CAISSES.** Châssis porteur en tube d'acier verni à pondres époxydes. Roues Ø 200. Charge kg 200.
-  **KASTENWAGEN.** Stahlgestell mit Epoxydpulverbeschichtung. Rollen Ø 200. Tragfähigkeit: kg 200.



CA 1473

€ 115,00

DIMENSIONI ESTERNE - EXTERNAL DIMENSIONS LxPxH cm
DIMENSIONS EXTERIEURES - AUBENABMESSUNGEN LxPxH cm

50x45x105 h

Carrelli portavalige e portabiti - Luggage and Clothing stands

Chariots porte-valises et porte-habits - Kofferwagen und Kleiderständerwagen

 Struttura in tubo di acciaio inox. Base in lamiera d'acciaio inox. Ruote Ø mm 140. 2 fisse, 2 piroettanti.

 Stainless steel frame. Stainless steel shelf. 2 swivelling wheels. 2 fixed wheels Ømm 140.

 Châssis porteur en tube d'acier inox. Base en acier inox. 2 roues fixes. 2 roues pivotantes Ø mm 140.

 Gestell aus Edelstahl. Untergestell aus rostfreiem Stahlblech. Rollen Ø 140 mm, 2 feste, 2 drehbare.

 Stender portabiti. Struttura in tubo di acciaio cromato. Asta allungabile cm 30 ogni lato. Ruote piroettanti.

 Clothing stand. Chromium-plated steel frame. Rod extendable 30 cm each side. Swivelling wheels.

 Chariot porte-habites. Châssis porteur en tube d'acier chromé. Tige allongable cm30 de chaque coté. Roues pivotantes.

 Kleiderständer. Gestell aus verchromtem Stahlrohr. 30 cm an beiden Seiten ausziehbarer Stange. Pirouettierende Rollen.



PVI 4024

€ 375,00

DIMENSIONI ESTERNE - EXTERNAL DIMENSIONS LxPxH cm
DIMENSIONS EXTERIEURES - AUßENABMESSUNGEN LxPxH cm

100x56x160 h

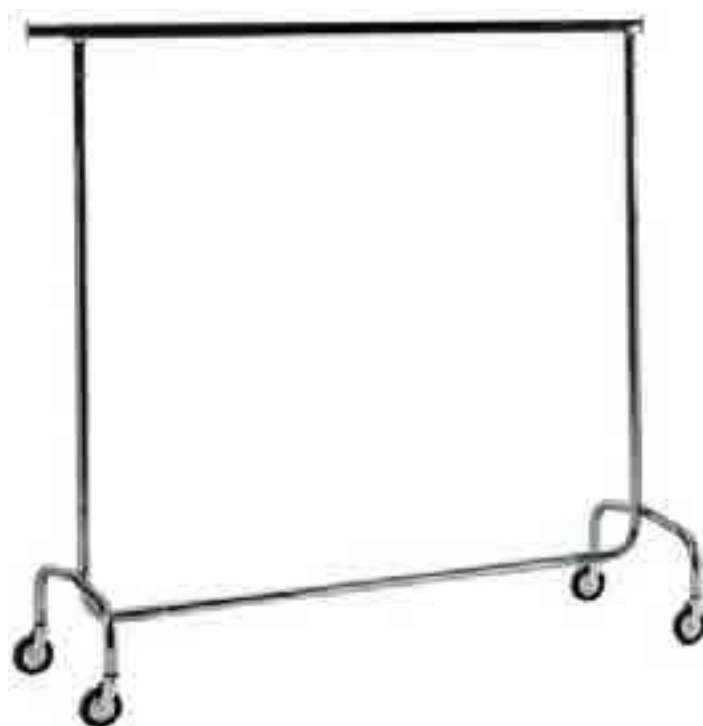

ST 4060

€ 90,00



DIMENSIONI ESTERNE LxPxH cm APERTO
EXTERNAL DIMENSIONS LxPxH cm OPEN
DIMENSIONS EXTERIEURES LxPxH cm OUVERT
AUßENABMESSUNGEN LxPxH cm OFFEN



210x53x152 h

DIMENSIONI ESTERNE LxPxH cm CHIUSO
EXTERNAL DIMENSIONS LxPxH cm CLOSED
DIMENSIONS EXTERIEURES LxPxH cm FERMÉ
AUßENABMESSUNGEN LxPxH cm VERSCHLOSSEN

150x53x152 h

Reggialige - Luggage rack Porte-valises - Kofferhalter

 Struttura in legno. Telo cotone.
 Wood luggage rack. Cotton cloth.

 Structure en bois. Toile en coton.
 Gestell aus Holz, Blatt aus Baumwollstoff



Faggio con sponda - Beech with side-wall
Hêtre avec bande - Buchen mit Rand

RE 4016

€ 52,00



Faggio senza sponda - Beech without side-wall
Hêtre sans bande - Buchen ohne Rand

RE 4018

€ 52,00

Noce con sponda - Walnut with side-wall
Noyer avec bande - Nussbaum mit Rand

RE 4017

€ 52,00

Noce senza sponda - Walnut without side-wall
Noyer sans bande - Nussbaum ohne Rand

RE 4019

€ 52,00

DIMENSIONI ESTERNE - EXTERNAL DIMENSIONS LxPxH cm
DIMENSIONS EXTERIEURES - AUßENABMESSUNGEN LxPxH cm

50x46x58 h

DIMENSIONI ESTERNE - EXTERNAL DIMENSIONS LxPxH cm
DIMENSIONS EXTERIEURES - AUßENABMESSUNGEN LxPxH cm

50x41x58 h

Carrelli da trasporto pesante - Heavy load trolley

Chariots de transport pesant - Schwere Transportwagen

 **CARRELLO CON PIANALE BASSO.** Pianale in lamiera di acciaio inox. Manico smontabile. Ruote Ø 140 di cui 2 fisse e 2 girevoli.

 **LOW PLATFORM TROLLEY.** Platform in stainless steel. Removable tubular stainless steel handle-bar. n. 2 swivelling wheels and 2 fixed wheels Ø 140.

 **CHARIOT AVEC PLATE-FORME BASSE.** Platte-forme en acier inox. Manche en tube inox démontable. 2 roues fixes, 2 roues pivotantes Ø 140.

 **WAGEN MIT NIEDRIGER PLATTFORM.** Wagen mit niedriger Platte aus rostfreiem Stahllaminat. Abmontierbarer Griff 2 feste und 2 drehbare Rollen von Ø 140.



CPB 1474

€ 300,00

DIMENSIONI ESTERNE - EXTERNAL DIMENSIONS LxPxH cm
DIMENSIONS EXTERIEURES - AUßENABMESSUNGEN LxPxH cm

61x122x90 h



Con doppio manico - With double handle
Avec poignée double - Mit Doppelgriff

CPB 1472

€ 335,00

DIMENSIONI ESTERNE - EXTERNAL DIMENSIONS LxPxH cm
DIMENSIONS EXTERIEURES - AUßENABMESSUNGEN LxPxH cm

56x110x85 h

Optionals

A 518

Ruote con freno - Wheels with catch - Roues avec frein - Räder mit Bremse

€ 20,00 cad./each

Macchina pulisci-scarpe - Shoeshine machine **Machine nettoyeuse de chaussures - Apparat zum Schuhe putzen**

- Struttura in lamiera verniciata a polveri epossidiche. Spazzole in cotone e crine. Dispensatore per crema. Motore elettrico V 230 50 Hz 150 W. Pulsante di accensione con temporizzatore elettrico.
- Painted steel structure. Cotton and horse hair brushes. Creme dispenser. Electric engine V 230 50 Hz 150 W. Switch with electrical timer.
- Structure en tôle vernie. Brosses en coton et crin. Dispensateur de crème. Moteur électrique V 230 50 Hz 150 W. Bouton d'allumage avec temporisateur électrique.
- Gestell aus Blech mit Epoxydharzbeschichtung. Bürsten aus Baumwolle und Roßhaar. Schumecremespender. Elektromotor V 230 50 Hz 150 W.
- Struttura in lamiera verniciata a polveri epossidiche. Spazzole in cotone e crine. Motore elettrico V 230 50 Hz W 150. Pulsante di accensione con temporizzatore elettrico.
- Painted steel structure. Cotton and horse hair brushes. Electric engine V 230 50 Hz W 150 Switch with electrical timer.
- Structure en tôle vernie. Brosses en coton et crin. Moteur électrique V 230 50 Hz W 150. Bouton d'allumage avec temporisateur électrique.
- Gestell aus Blech mit Epoxydharzbeschichtung. Bürsten aus Baumwolle und Roßhaar. Elektromotor V 230 50 Hz W 150.



LU 4120 Bianco - White **€ 720,00**

LU 4120G Grigio - Grey **€ 720,00**

DIMENSIONI ESTERNE - EXTERNAL DIMENSIONS LxPxH cm
DIMENSIONS EXTERIEURES - AUßENABMESSUNGEN LxPxH cm

62x30x83 h

LU 4131 Bianco - White **€ 600,00**

LU 4131G Grigio - Grey **€ 600,00**

DIMENSIONI ESTERNE - EXTERNAL DIMENSIONS LxPxH cm
DIMENSIONS EXTERIEURES - AUßENABMESSUNGEN LxPxH cm

42x30x83 h

Aste delimita-corsie - Lane poles

Tige de délimitation de passage - Bahnabgrenzungsstangen



Altezza 100 cm
Height 100 cm
Hauteur 100 cm
Höhe 100 cm

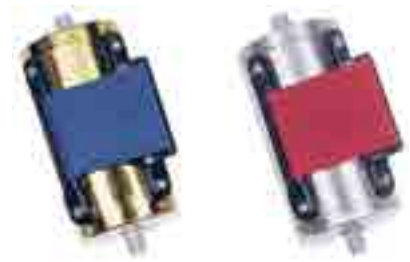

Asta dorata con nastro avvolgibile mt.2 Blu
Golden bar with 2mt. blue roll up band
Hampe dorée avec bande enroulable bleu 2mt.
Vergoldete Stange mit aufwickelbarem Band 2mt. blau

ACF5190DB

€ 80,00

Puntale dorato con nastro blu
Golden tip with blue band
Embout dorée avec bande bleu
Vergoldete Spitze mit blauem Band

PU5195DB

€ 33,00

Asta dorata con nastro avvolgibile mt.2 Rosso
Golden bar with 2mt. red roll up band
Hampe dorée avec bande enroulable rouge 2mt.
Vergoldete Stange mit aufwickelbarem Band 2mt. rot

ACF5190DR

€ 80,00

Puntale dorato con nastro rosso
Golden tip with red band
Embout dorée avec bande rouge
Vergoldete Spitze mit rotem Band

PU5195DR

€ 33,00

Asta inox lucido con nastro avvolgibile mt.2 Blu
Polished s/s bar with 2mt. blue roll up band
Hampe en acier inoxydable brillant avec bande enroulable bleu 2mt.
Stange aus poliertem rostfreiem Stahl mit aufwickelbarem Band 2mt. blau

ACF5190IB

€ 80,00

Puntale inox lucido con nastro blu
Polished s/s tip with blue band
Embout en acier inoxydable brillant avec bande bleu
Spitze aus poliertem rostfreiem Stahl mit blauem Band

PU5195IB

€ 33,00

Asta inox lucido con nastro avvolgibile mt.2 Rosso
Polished s/s bar with 2mt. red roll up band
Hampe en acier inoxydable brillant avec bande enroulable rouge 2mt.
Stange aus poliertem rostfreiem Stahl mit aufwickelbarem Band 2mt. rot

ACF5190IR

€ 80,00

Puntale inox lucido con nastro rosso
Polished s/s tip with red band
Embout en acier inoxydable brillant avec bande rouge
Spitze aus poliertem rostfreiem Stahl mit rotem Band

PU5195IR

€ 33,00

Asta nera con nastro avvolgibile mt.2 Blu
Black bar with 2mt. blue roll up band
Hampe noire avec bande enroulable bleu 2mt.
Schwarze Stange mit aufwickelbarem Band 2mt. blau

ACF5190NB

€ 80,00

Puntale nero con nastro blu
Black tip with blue band
Embout noir avec bande blue
Scharze Spitze mit blauem Band

PU5195NB

€ 33,00

Asta nera con nastro avvolgibile mt.2 Rosso
Black bar with 2mt. red roll up band
Hampe noire avec bande enroulable rouge 2mt.
Schwarze Stange mit aufwickelbarem Band 2mt. rot

ACF5190NR

€ 80,00

Puntale nero con nastro rosso
Black tip with red band
Embout noir avec bande rouge
Scharze Spitze mit rotem Band

PU5195NR

€ 33,00

Aste delimita-corsie - Lane poles
Tige de délimitation de passage - Bahnabgrenzungsstangen



Asta dorata delimita corsie per cordoni a treccia
 Golden bar for interlaced cords
 Hampe dorée pour cordons tressés
 Vergoldete Stange Bahnabgrenzungsstange für Zopfseile.

AC 5118D

€ 80,00

Asta inox lucido delimita corsie per cordoni a treccia
 Polished s/s bar for interlaced cords
 Hampe en acier inoxydable brillant pour cordons tressés
 Bahnabgrenzungsstange aus Poliertem rostfreiem Stahl für Zopfseile

AC 5118I

€ 80,00

Altezza 90 cm
 Height 90 cm
 Hauteur 90 cm
 Höhe 90 cm



Puntale dorato per cordoni
 Golden tip for cords
 Embout dorée pour cordons
 Vergoldete Spitze für Seile

PU5144D

€ 15,00

Puntale inox lucido per cordoni
 Polished s/s tip for cords
 Embout en acier inoxydable brillant pour cordons
 Spitze aus rostfreiem Poliertem Stahl für Seile

PU5144I

€ 15,00



Gancio a muro ottonato
 Brass painted wall hook
 Crochet à mur cuivré
 Vermessingter Wandhaken

GA 5144D

€ 15,00

Gancio a muro inox
 Stainless steel wall hook
 Crochet à mur en acier inoxydable
 Wandhaken aus rostfreiem Stahl

GA 5144I

€ 15,00



Cordone per aste - Cords for bars
 Cordes pour hampes - Seile für Stangen
 Colori: bordeaux, oro, verde, blu
 Colours: bordeaux, golden, green, blue

C04099

€ 30,00 al metro - each meter

DIMENSIONI ESTERNE - EXTERNAL DIMENSIONS
 DIMENSIONS EXTERIEURES - AUBENABMESSUNGEN

Ø 30 mm

Pattumiere e portarifuti



Posacenere gettacarta inox con coperchio a rete cromata

Gettacarte Autoestinguenta 50 lt.

Portarifuti carrellato con struttura a forma cilindrica in acciaio inox

Tramoggia su ruote costruita interamente in acciaio inox

Colorati per raccolta differenziata. Contenitore in polietilene litri 120. Ruote Ø 200

Garbage and dust bin



Stainless steel ash and paper-tray with chromium-plated wire net cover

Auto-extinguishing waste bin 50 lt.

Wheeled refuse bin with stainless steel cylindrical-shaped bin

Bin on castors, constructed entirely in satin-finish stainless steel

Coloured for recycling. Polyethylene container 120 litres. Wheels diam. 200

Boîtes à ordures et poubelles



Cendrier et pose-papier en acier inoxydable avec couvercle à grille, chromée

Pase-papier anti-feu 50 lt.

Poubelle sur roue avec structure de forme cylindrique, en acier inox

Trémie sur roues entièrement construite en acier inox

Colorées pour ramassage sélectif. Poubelle en polyéthylène 120 litres. Roulettes Ø 200

Abfallbehälter



Rostfreier Aschen-und Papierbecher mit verchromtem Gitterdekkel

Feuerlöschpapierbecher 50 lt.



Fahrbarern runder Abfalbehälter aus Edelstahl

Fahrbarer Behälter vollständig aus satiniertem Edelstahl konstruiert

Farbig für mülltrennung. Behälter aus polyäthylen 120 liter. Räder Ø 200

Pattumiere e portarifiuti - Garbage and dust bin Boîtes à ordures et poubelles - Abfallbehälter



-  Posacenere gettacarta inox con coperchio a rete cromata.
-  Stainless steel ash and paper-tray with chromium-plated wire net cover.
-  Cendrier et pose-papier en acier inoxydable avec couvercle à grille, chromée.
-  Rostfreier Aschen-und Papierbecher mit verchromtem Gitterdekkel.

AV 4650

€ 90,00

DIMENSIONI ESTERNE - EXTERNAL DIMENSIONS LxPxH cm
DIMENSIONS EXTERIEURES - AUßENABMESSUNGEN LxPxH cm

Ø 20 - 60 h





AV 4651

€ 140,00

DIMENSIONI ESTERNE - EXTERNAL DIMENSIONS LxPxH cm
DIMENSIONS EXTERIEURES - AUßENABMESSUNGEN LxPxH cm

Ø 25 - 70 h



-  Gettacarte Autoestinguente 50 lt. Acciaio inox satinato. Testa soffocante per l'arresto della propagazione del fuoco. Base in gomma.
-  Auto-extinguishing waste bin 50 lt. Brushed stainless steel. Self extinguishing top. Rubber round base.
-  Pase-papier anti-feu 50 lt. Acier inox satiné. Couvercle étouffe-feu. Base en caoutchouc.
-  Feuerlöschpapierbecher 50 lt. Satinedelstahl. Kopfe um das Feuer zu ersticken. Gummi-grund.





AV 4620

€ 120,00

DIMENSIONI ESTERNE - EXTERNAL DIMENSIONS LxPxH cm
DIMENSIONS EXTERIEURES - AUßENABMESSUNGEN LxPxH cm

Ø 31 - 59 h



-  Tramoggia su ruote costruita interamente in Acciaio inox satinato con coperchio asportabile.
-  Bin on castors, constructed entirely in satin-finish stainless steel with removable lid.
-  Trémie sur roues entièrement construite en acier inox satiné avec couvercle amovible.
-  Fahrbarer Behälter vollständig aus satiniertem Edelstahl konstruiert, mit abnehmbaren Deckel.

AV 4666

€ 370,00

DIMENSIONI ESTERNE - EXTERNAL DIMENSIONS LxPxH cm
DIMENSIONS EXTERIEURES - AUßENABMESSUNGEN LxPxH cm

61x40x73 h

Con separatore interno - With internal separator - Avec séparateur intérieur
- Mit innerem Abscheider

AV 4680

€ 420,00

DIMENSIONI ESTERNE - EXTERNAL DIMENSIONS LxPxH cm
DIMENSIONS EXTERIEURES - AUßENABMESSUNGEN LxPxH cm

61x40x73 h

Pattumiere e portarifiuti - Garbage and dust bin
Boîtes à ordures et poubelles - Abfallbehälter

- Colorati per raccolta differenziata. Contenitore in polietilene litri 100. Ruote Ø 143. Impilabile con ruote montate.
- Coloured for recycling. Polyethylene container 100 litres. Wheels diam. 143. Stackable with mounted wheels.
- Colorées pour ramassage sélectif. Poubelle en polyéthylène 100 litres. Roulettes Ø 143. Empilables avec roues montées.
- Farbig für Mülltrennung. Behälter aus Polyäthylen 100 Liter. Räder Ø 143. Stapelbar mit montierten Rädern.



GRIGIO/GIALLO
GREY/YELLOW



GRIGIO/BLU
GREY/BLUE



GRIGIO/VERDE
GREY/GREEN



GRIGIO/ROSSO
GREY/RED

AV 4682

€ 50,00

DIMENSIONI ESTERNE - EXTERNAL DIMENSIONS LxPxH cm
 DIMENSIONS EXTERIEURES - AUßENABMESSUNGEN LxPxH cm

54x49x85

- Colorati per raccolta differenziata. Contenitore in polietilene litri 120. Ruote Ø 200.
- Coloured for recycling. Polyethylene container 120 litres. Wheels diam. 200.
- Colorées pour ramassage sélectif. Poubelle en polyéthylène 120 litres. Roulettes Ø 200.
- Farbig für Mülltrennung. Behälter aus Polyäthylen 120 Liter. Räder Ø 200.



AV 4674 + RC0075



AV 4675



AV 4676



AV 4678



AV 4679

Colore bianco - White - Couleur blanche - Weiße Farbe

AV 4674

€ 80,00

DIMENSIONI ESTERNE - EXTERNAL DIMENSIONS LxPxH cm
 DIMENSIONS EXTERIEURES - AUßENABMESSUNGEN LxPxH cm

55x48x93

Pedale apricoperchio per contenitore - Opening pedal for the container's lid
 Pédale ouvre-couvercle pour conteneur - Deckelöffnerpedal fuer Behälter

RC 0075 optional

€ 38,00

Pattumiere e portarifiuti - Garbage and dust bin Boîtes à ordures et poubelles - Abfallbehälter

- Portarifiuti carrellato con struttura a forma cilindrica in acciaio inox, completo di coperchio stampato, ruote piroettanti. Disponibile anche modello con comando a pedale, fondo a tenuta stagna.
- Wheeled refuse bin with stainless steel cylindrical-shaped bin, complete with moulded lid and castors. Pedal-controlled model also available, watertight bottom.



- Poubelle sur roue avec structure de forme cylindrique, en acier inox, complète de couvercle moulé, roues pivotantes. Une version avec commande à pédale peut être également livrée, fond étanche.
- Fahbarem runder Abfallbehälter aus Edelstahl, komplett mit geprüfstem Deckel und Lenkrollen. Auch als Modell mit Pedalbedienung verfügbar, Vollkommen undurchlaessig, Dicht des Bodens.



AV 4667 € 200,00

DIMENSIONI ESTERNE - EXTERNAL DIMENSIONS LxPxH cm
DIMENSIONS EXTERIEURES - AUßENABMESSUNGEN LxPxH cm **Ø 39 x 60 h / 50 lt**

AV 4669 € 180,00

DIMENSIONI ESTERNE - EXTERNAL DIMENSIONS LxPxH cm
DIMENSIONS EXTERIEURES - AUßENABMESSUNGEN LxPxH cm **Ø 46 x 70 h / 100 lt**

AV 4668 € 230,00

DIMENSIONI ESTERNE - EXTERNAL DIMENSIONS LxPxH cm
DIMENSIONS EXTERIEURES - AUßENABMESSUNGEN LxPxH cm **Ø 46 x 70 h / 100 lt**



- Pattumiere tonde in acciaio inox con cestello interno in metallo e pedale.
- Stainless steel round dust-bins. Metal inside basket and pedal.
- Poubelle ronde en acier inoxydable. Panier intérieur en metal et pédale.
- Runde Abfalleimer aus rostfreiem Stahl mit internem Eimer aus Metal und Fußhebel.

AV 4660 € 180,00

DIMENSIONI ESTERNE - EXTERNAL DIMENSIONS LxPxH cm
DIMENSIONS EXTERIEURES - AUßENABMESSUNGEN LxPxH cm **Ø 32-59 h / 30 lt**





AV 4661 € 185,00

DIMENSIONI ESTERNE - EXTERNAL DIMENSIONS LxPxH cm
DIMENSIONS EXTERIEURES - AUßENABMESSUNGEN LxPxH cm **Ø 32-74 h / 40 lt**

AV 4663 € 315,00

DIMENSIONI ESTERNE - EXTERNAL DIMENSIONS LxPxH cm
DIMENSIONS EXTERIEURES - AUßENABMESSUNGEN LxPxH cm **Ø 41-71 h / 80 lt**

**Pattumiere e portarifiuti - Garbage and dust bin
Boîtes à ordures et poubelles - Abfallbehälter**

-  Con ruote, senza pedale e secchio interno.
-  With wheels, without pedal and internal bucket.
-  Avec roues, sans pédale ni seau interne.
-  Mit Räder, ohne Pedal und Inneneimer.







AV 4671

€ 215,00

DIMENSIONI ESTERNE - EXTERNAL DIMENSIONS LxPxH cm
DIMENSIONS EXTERIEURES - AUßENABMESSUNGEN LxPxH cm

Ø 39-60 h / 63 lt

-  Pattumiera rettangolare inox con 2 ruote e pedale. Estrazione sacco anteriore.
-  Stainless steel rectangular dust-bins. 2 wheels and pedale. Front sack extraction.
-  Poubelle rectangulaire en acier inoxydable. 2 roues et pédale. Ex-traction du sac antérieur.
-  Rechteckige Abfalleimer aus rostfreiem Stahl. 2 Räder und Fußhe-bel. Vordener, herausnehmbarer Sack.



AV 4652

€ 350,00

DIMENSIONI ESTERNE - EXTERNAL DIMENSIONS LxPxH cm
DIMENSIONS EXTERIEURES - AUßENABMESSUNGEN LxPxH cm

49x50x101 h / 100 lt





AV 4654

€ 290,00

DIMENSIONI ESTERNE - EXTERNAL DIMENSIONS LxPxH cm
DIMENSIONS EXTERIEURES - AUßENABMESSUNGEN LxPxH cm

49x50x79 h / 70 lt

Pattumiere e portarifiuti - Garbage and dust bin Boîtes à ordures et poubelles - Abfallbehälter

-  Pattumiera porta sacco rifiuti grande, attacco rotondo in acciaio inox, con coperchio con apertura a pedale.
-  Stainless steel dustbin for big waste sacks, round fastening, with pedal opening cover.
-  Poubelle en acier inoxydable pour sacs à déchets grands, fermeture ronde, avec couvercle ouvrable par pédale.
-  Abfalleimer aus Edelstahl für große Abfallsäcke, runde Befestigung, mit Deckel und Pedalöffnung.







AV 4681

€ 185,00

DIMENSIONI ESTERNE - EXTERNAL DIMENSIONS LxPxH cm
DIMENSIONS EXTERIEURES - AUßENABMESSUNGEN LxPxH cm

55x45x85

-  Carrello "X" portasacco verniciato, attacco rotondo, coperchio in plastica rotondo con aggancio, cestino portaoggetti plastificato.
-  "X" trolley. Polished sack holder, round connection. Round plastic cover with hook. Plasticized basket.
-  Chariot "X" porte-sacs verni, point d'attache rond. Couvercie rond en plastique avec crochet. Panier porte-object plastifié.
-  Lackierter Waeschesackwagen "X", runde Sackhalterung, runder Kunststoffdeckel mit Hakenkunststoffbeschichteter Korb.



CA 1602 verniciato con cestino

€ 150,00

CA 1603 cromato con pedale

€ 170,00

DIMENSIONI ESTERNE - EXTERNAL DIMENSIONS LxPxH cm
DIMENSIONS EXTERIEURES - AUßENABMESSUNGEN LxPxH cm

58x56x102 h

Chafing dishes gastronom 
Distributori per caffè, caffè caldo, bevande, cereali
Zuppiera elettrica
Fornello flambé a gas
Elemento elettrico riscaldante
Pasta combustibile
Padella flambè





Chafing Dish 
Distributors for coffee, hot coffee, beverages, cereals
Electric pan
Copper flambé gas-lamp
Electric heating element
Fuel tubs
Cuprum-stainless steel

Bain-marie 
Distributeurs de café, café chaud, boissons, céréales
Réceptacle électrique
Fourneau flambé à gas en cuivre
Élément électrique chauffant
Gel combustible
Poêle flambé

Chafing Dish 
Distributoren für Kaffee, heißen Kaffee, Getränke, Getreide
Elektrische wanne
Flambégas aus Kupper
Elektrische Heizapparat
Brennpaste
Flambépfanne

Chafing dishes gastronorm - Chafing Dish

Bain-marie - Chafing Dish

-  Chafing dish con coperchio. Rettangolare in acciaio inox con bruciatori ad alcool.
-  Chafing dish with lid. Rectangular in s/s with alcohol burners.
-  Bain-marie avec couvercle. Rectangulaire en acier inoxydable avec brûleurs à alcool.
-  Chafing Dish mit Deckel. Rechteckiges aus Edelstahl mit Alkohol Brenner.







CD 7905

€ 100,00

DIMENSIONI ESTERNE - EXTERNAL DIMENSIONS LxPxH cm
DIMENSIONS EXTERIEURES - AUßENABMESSUNGEN LxPxH cm

67x37x41 h

-  Chafing dish con coperchio roll top in acciaio inox lucido con bruciatori ad alcool.
-  Chafing dish with polisher stainless, roll top steel lid with alcohol burners.
-  Bain-marie avec couvercle, roll top en acier inoxydable brillant avec brûleurs à alcool.
-  Chafing Dish mit Deckel, Roll top aus poliertem Edelstahl mit Alkohol Brenner.







CD 9801

€ 238,00

DIMENSIONI ESTERNE - EXTERNAL DIMENSIONS LxPxH cm
DIMENSIONS EXTERIEURES - AUßENABMESSUNGEN LxPxH cm

65x47x45 h

Optional resistenza elettrica (vedi pag. 170) - On demand electric resistance (see page 170)
Sur demande résistance électrique (voir page 170) - Auf Anfrage elektrischen Widerstand (sehen Sie Seite 170)

-  Chafing dish con coperchio roll top 180° in acciaio inox lucido con bruciatori ad alcool.
-  Chafing dish with roll top lid 180° in polished s/s with alcohol burners.
-  Bain-marie avec couvercle, roll top 180° en acier inoxydable brillant avec brûleurs à alcool.
-  Chafing Dish mit Deckel, Roll top 180° aus poliertem Edelstahl mit Alkohol Brenner.







CD 6502

€ 430,00

DIMENSIONI ESTERNE - EXTERNAL DIMENSIONS LxPxH cm
DIMENSIONS EXTERIEURES - AUßENABMESSUNGEN LxPxH cm

65x47x45 h

-  Chafing dish tondo con coperchio roll top 180° in acciaio inox lucido con bruciatori ad alcool.
-  Round chafing dish with roll top lid 180° in polished s/s with alcohol burners.
-  Rond bain-marie avec couvercle roll top 180° en acier inoxydable brillant avec brûleurs à alcool.
-  Rundes Chafing Dish mit Deckel Roll top 180° aus poliertem Edelstahl mit Alkohol Brenner.



CD 6504

€ 395,00

DIMENSIONI ESTERNE - EXTERNAL DIMENSIONS LxPxH cm
DIMENSIONS EXTERIEURES - AUßENABMESSUNGEN LxPxH cm

50x52x45 h

Chafing dishes gastronorm, Distributori, Zuppiera elettrica - Chafing Dish, Distributors, Electric pan Bain-marie, Distributeurs, Récipient électrique - Chafing Dish, Distributoren, Elektrische wanne

 Chafing dish con coperchio roll top 180° con pentole Lt. 4,6 in acciaio inox lucido con bruciatori ad alcool.

 Chafing dish with roll top lid 180° with cookers Lt. 4,6 in polished s/s with alcohol burners.

 Bain-marie avec couvercle roll top 180° avec casseroles Lt. 4,6 en acier inoxydable brillant avec brûleurs à alcool.

 Chafing mit Roll Dish Top Deckel 180° mit Töpfe Lt. 4,6 aus poliertem Edelstahl mit Alkohol Brenner.



CD 6505

€ 500,00

DIMENSIONI ESTERNE - EXTERNAL DIMENSIONS LxPxH cm
DIMENSIONS EXTERIEURES - AUßENABMESSUNGEN LxPxH cm

65x47x45 h

 DISTRIBUTORE CAFFÈ. Distributore inox per bevande calde Lt 9 con bruciatore ad alcool.

 COFFEE DISTRIBUTOR. Distributor in s/s for hot beverages Lt. 9 with alcohol burner.

 DISTRIBUTEUR À CAFÉ. Distributeur en acier inox pour boissons Lt. 9 chaudes avec brûler à alcool.

 KAFFEESTENDER. Spender aus rostfreiem Stahl für warme Getränke Lt. 9 mit Alkohol Brenner.



DC 10502

€ 270,00

DIMENSIONI ESTERNE - EXTERNAL DIMENSIONS LxPxH cm
DIMENSIONS EXTERIEURES - AUßENABMESSUNGEN LxPxH cm

33x24x54 h

**Optional resistenza elettrica (vedi pag. 170) - On demand electric resistance (see page 170)
Sur demande résistance électrique (voir page 170) - Auf Anfrage elektrischen Widerstand (sehen Sie Seite 170)**

 ZUPPIERA ELETTRICA. Zuppiera elettrica Lt 10 600 W 230 V. Corpo in alluminio verniciato epossidico. Contenitore e coperchio inox.

 ELECTRIC PAN. Electric pan Lt 10 600W 230V. Frame in painted aluminium epoxy. Container and lid in stainless steel.

 RÉCIPIENT ÉLECTRIQUE. Récipient électrique Lt 10 600W 230V. Structure en aluminium verni époxyde. Cuvette et couvercle en acier inox.

 ELEKTRISCHE WANNE. Elektrische Wanne Lt 10 600W 230V Aufbau aus epoxy lackiertem Aluminium Behälter und Deckel aus Edelstahl.





B 8001

€ 220,00

DIMENSIONI ESTERNE - EXTERNAL DIMENSIONS LxPxH cm
DIMENSIONS EXTERIEURES - AUßENABMESSUNGEN LxPxH cm

Ø 35x36 h

 DISTRIBUTORE CALDO PER CAFFÈ. Struttura in ABS con copertura in acciaio inox. Capacità Lt. 6,8 (circa 40 tazzine). Alimentazione 230V 50Hz 1100W. Dotato di termica di sicurezza. Temperatura 90°C.

 WARNING DISTRIBUTOR FOR COFFEE. ABS astructure covered with stainless steel. Capacity 6,8 Lt. (40 coffee cups approx.). Power supply 230V 50 Hz 1100W. Equipped with safety thermic protector. Temperature 90°C.

 DISTRIBUTEUR CHAUFFANT POUR CAFÉ. Structure en ABS plaquée en acier inox. Capacité 6,8 Lt. (40 tasses à café environ). Alimentation 230V 50Hz 1100W. Equipé de protection thermique de sécurité. Temperature 90°C.

 HEIZSPENDER FÜR KAFFEE. Struktur aus ABS verkleidet mit Edelstahl. Kapazität 6,8 Lt. (40 Kaffee-Tassen zirka). Anschluss 230V 50Hz 1100W. Sicherheitsthermoschutz. Temperatur 90°C.



DCN 1706

€ 140,00





DIMENSIONI ESTERNE - EXTERNAL DIMENSIONS LxPxH cm
DIMENSIONS EXTERIEURES - AUßENABMESSUNGEN LxPxH cm

Ø 29x44 h

Distributori - Distributors

Distributeurs - Distributoren



-  **DISTRIBUTORE CEREALI.** Distributore inox con contenitore trasparente Lt. 8 neutro per cereali.
-  **CEREALS DISTRIBUTOR.** S/s distributor for cereals. Equipped with a 8 lt transparent container.
-  **DISTRIBUTEUR DE CÉRÉALES.** Distributeur en acier inoxydable pour céréales avec conteneur transparent, capacité: 8 tl.
-  **GETREIDESPENDER.** Spender aus rostfreiem Stahl mit transparentem Behälter für Getreide.





DC 10301

€ 175,00

DIMENSIONI ESTERNE - EXTERNAL DIMENSIONS LxPxH cm
DIMENSIONS EXTERIEURES - AUßENABMESSUNGEN LxPxH cm

36x26x66 h



-  Distributore cereali doppio Lt. 8+8
-  Double cereals distributor Lt. 8+8
-  Distributeur double de céréales Lt. 8+8
-  Doppel Getreidespender Lt. 8+8





DC 10302

€ 330,00

DIMENSIONI ESTERNE - EXTERNAL DIMENSIONS LxPxH cm
DIMENSIONS EXTERIEURES - AUßENABMESSUNGEN LxPxH cm

48x26x66 h



-  **DISTRIBUTORE BEVANDE.** Distributore inox con contenitore trasparente lt. 8. Tubo centrale per contenimento ghiaccio.
-  **DISTRIBUTOR FOR BEVERAGES.** Distributor in s/s with transparent container lt. 8. Central pipe containing ice.
-  **DISTRIBUTEUR À BOISSONS.** Distributeur en acier inox avec conteneur transparent lt. 8. Tuyau central pour contenir la glace.
-  **GETRÄNKESPENDER.** Spender aus rostfreiem Stahl mit transparent Behälter lt. 8. Zentraler Rohr für Eis-Behaltung.





DS 10401

€ 215,00

DIMENSIONI ESTERNE - EXTERNAL DIMENSIONS LxPxH cm
DIMENSIONS EXTERIEURES - AUßENABMESSUNGEN LxPxH cm

27x22x58 h







-  Distributore bevande doppio Lt. 5+5
-  Double beverages distributor Lt. 5+5
-  Distributeur double à boissons Lt. 5+5
-  Doppel Getränkespender Lt. 5+5

DS 10402

€ 410,00

DIMENSIONI ESTERNE - EXTERNAL DIMENSIONS LxPxH cm
DIMENSIONS EXTERIEURES - AUßENABMESSUNGEN LxPxH cm

35x32x58 h

-  Fornello flambé a gas in rame con griglia inox.
-  Copper flambé gas-lamp with stainless steel grill.
-  Fourneau flambé à gas en cuivre avec grille en acier inoxydable.
-  Flambégas aus Kopper mit Gitter aus rostfreiem Stahl.







AV 4561

€ 305,00

DIMENSIONI ESTERNE - EXTERNAL DIMENSIONS LxPxH cm
DIMENSIONS EXTERIEURES - AUßENABMESSUNGEN LxPxH cm

Ø 26x29,5 h

-  Padella flambé inox-cuprum, manico legno.
-  Cuprum-stainless steel, flambé pan, wooden handle.
-  Poêle flambé. Acier inoxydable - cuprum, poignée en bois.
-  Flambépfanne. Cuprum-rostfreiem Stahl. Handgriff aus Holz.



AV 4580

€ 125,00

DIMENSIONI ESTERNE - EXTERNAL DIMENSIONS LxPxH cm
DIMENSIONS EXTERIEURES - AUßENABMESSUNGEN LxPxH cm





Ø 29

AV 4581

€ 115,00

DIMENSIONI ESTERNE - EXTERNAL DIMENSIONS LxPxH cm
DIMENSIONS EXTERIEURES - AUßENABMESSUNGEN LxPxH cm

Ø 26





-  Pasta combustibile in barattolo da 200 g netto.
-  Fuel. In tins of 200 g (7 oz) net capacity.
-  Gel combustibile. En boite de 200 g net.
-  Brennpaste. In Dosen zu 200 g netto.



AV 9303

€ 95,00

Confezione n. 72 barattoli - Set of 72 cans
Set de 72 boites - Verpackung 72 Dosen

-  Pasta combustibile in secchi da 4 kg netto.
-  Fuel tubs of 8.8 lb net capacity.
-  Gel combustibile, bidons de 4 kg net.
-  Brennpaste. In Kesseln zu 4 kg netto.







AV 9300

€ 88,00

Confezione n. 4 secchi / Set of 4 tubs
Set de 4 bidons / Verpackung 4 Kesseln

Accessori - Accessories Accessoires - Zubehör





-  Elemento elettrico riscaldante 180 W. Per DC 10502
-  Electric heating element 180 W. For DC 10502
-  Élément électrique chauffant 180 W. Pour DC 10502
-  Elektrische Heizapparat 180 W. Für DC 10502



AV9517

€ 88,00

Applicabile ai seguenti articoli - Available for the following items
Disponible pour les articles suivant - Verfügar für die folgende Artikel
DC10502

-  Elemento di riscaldamento elettrico per Chafing Dishes 230 V 50/60 Hz 360 W.
-  Electric heating element fot Chafing Dishes 230 V 50/60 Hz 360 W.
-  Élément électrique de chauffage pour Chafing Dishes 230 V 50/60 Hz 360 W.
-  Elektrischer Heizelement für Chafing Dishes 230 V 50/60 Hz 360 W.



AV9516

€ 100,00

Applicabile ai seguenti articoli - Available for the following items
Disponible pour les articles suivant - Verfügar für die folgende Artikel
CD 7905 - CD 9801 - CD 6502 - CD 6504 - CD 6505

Bacinelle gastronorm e vaschette per gelato 
Bacinelle gn in policarbonato
Accessori per cucina
Accessori per pizzeria
Bilancia elettronica

GN basins and ice cream drums 
GN pans in polycarbonate
Kitchen accessories
Accessories for pizzeria
Electronic scale

Bacs Gastronorm et bacs à glace 
Bacs GN en polycarbonate
Accessoires pour cuisines
Accessoires pour pizzeria
Bilance électronique

Gastronorm Schüssel und Eisschalen 
GN Polycarbonatbehälter
Kochzubehöre
Zubehör für Pizzerien
Elektronische Waage

Bacinele gastronorm e vaschette per gelato AISI 304 (18/10) - GN basins and ice cream drums AISI 304 (18/10)
Bacs Gastronom et bacs à glace AISI 304 (18/10) - Gastronom Schüssel und Eisschalen AISI 304 (18/10)



BACINELLE - CONTAINERS - CUVETTES - BEHÄLTER				dimensioni in mm - dimension in mm	
MOD. 2/1 EST. 646 x 530 INT. 620 x 500		GNI 21200 200 h / 60 lt € 93,00	GNI 2140 40 h / 12 lt € 43,00		
		GNI 21150 150 h / 44,9 lt € 82,00	GNI 2120 20 h / 6,5 lt € 38,00		
		GNI 21100 100 h / 31,5 lt € 60,00	GRI 21 Griglia € 35,00		
		GNI 2165 65 h / 18,9 lt € 46,00			
MOD. 1/1 EST. 530 x 325 INT. 500 x 300		GNI 11200 200 h / 30 lt € 50,00	GNI 1140 40 h / 5,5 lt € 21,00	FFF 11 Falso fondo forato € 19,00	
		GNI 11150 150 h / 20,6 lt € 42,00	GNI 1120 20 h / 2,5 lt € 18,00	GRI 11 Griglia € 19,00	
		GNI 11100 100 h / 13,3 lt € 30,00	COPI 11 Coperchio € 16,00	S 530 Separatore € 6,00	
		GNI 1165 65 h / 8,5 lt € 24,00	COPG 11 Coperchio a tenuta € 51,00		
MOD. 2/3 EST. 352 x 325 INT. 329 x 300		GNI 23200 200 h / 19,3 lt € 34,00	GNI 2340 40 h / 3,5 lt € 16,00	FFF 23 Falso fondo forato € 16,00	
		GNI 23150 150 h / 13,6 lt € 29,00	GNI 2320 20 h / 1,8 lt € 12,00	GRI 23 Griglia € 17,00	
		GNI 23100 100 h / 8,9 lt € 24,00	COPI 23 Coperchio € 13,00		
		GNI 2365 65 h / 5,5 lt € 18,00	COPG 23 Coperchio a tenuta € 38,00		
MOD. 1/2 EST. 325 x 265 INT. 300 x 238		GNI 12200 200 h / 11,6 lt € 29,00	GNI 1240 40 h / 2,5 lt € 12,00	FFF 12 Falso fondo forato € 11,00	
		GNI 12150 150 h / 9,9 lt € 24,00	GNI 1220 20 h / 1,2 lt € 10,00	S 325 Separatore € 5,00	
		GNI 12100 100 h / 8 lt € 19,00	COPI 12 Coperchio € 10,00		
		GNI 1265 65 h / 4,2 lt € 15,00	COPG 12 Coperchio a tenuta € 36,00		
MOD. 1/3 EST. 325 x 176 INT. 300 x 150		GNI 13200 200 h / 8,1 lt € 23,00	GNI 1340 40 h / 1,5 lt € 10,00	FFF 13 Falso fondo forato € 9,00	
		GNI 13150 150 h / 5,9 lt € 20,00	GNI 1320 20 h / 0,7 lt € 7,00		
		GNI 13100 100 h / 3,8 lt € 15,00	COPI 13 Coperchio € 8,00		
		GNI 1365 65 h / 2,5 lt € 12,00	COPG 13 Coperchio a tenuta € 31,00		
MOD. 1/4 EST. 265 x 162 INT. 238 x 136		GNI 14200 200 h / 4,9 lt € 21,00	GNI 1440 40 h / 1 lt € 8,00	S 265 Separatore € 5,00	
		GNI 14150 150 h / 4,1 lt € 16,00	GNI 1420 20 h / 0,5 lt € 6,00		
		GNI 14100 100 h / 2,5 lt € 14,00	COPI 14 Coperchio € 7,00		
		GNI 1465 65 h / 1,9 lt € 10,00	COPG 14 Coperchio a tenuta € 26,00		
MOD. 1/6 EST. 176 x 162 INT. 140 x 153		GNI 16200 200 h / 3 lt € 25,00	COPI 16 Coperchio € 5,50		
		GNI 16150 150 h / 2,5 lt € 15,00	COPG 16 Coperchio a tenuta € 25,00		
		GNI 16100 100 h / 1,6 lt € 12,00			
		GNI 1665 65 h / 1,1 lt € 10,00			
MOD. 1/9 EST. 176 x 108 INT. 140 x 100		GNI 19100 100 h / 0,9 lt € 12,00			
		GNI 1965 65 h / 0,5 lt € 9,00			
		COPI 19 Coperchio € 5,00			

Bacinelle gastronorm e vaschette per gelato AISI 304 (18/10) - GN basins and ice cream drums AISI 304 (18/10)
Bacs Gastronom et bacs à glace AISI 304 (18/10) - Gastronom Schüssel und Eisschalen AISI 304 (18/10)



BACINELLE FORATE - PIERCED BASINS - CUVETTES PERCÉES - LOCHSCHALE

dimensioni in mm - dimension in mm

MOD. 2/1 EST. 646 x 530 INT. 620 x 500		GNT 21200	200 h / 60 lt	€ 132,00
		GNT 21150	150 h / 44,9 lt	€ 115,00
		GNT 21100	100 h / 31,5 lt	€ 85,00
		GNT 2165	65 h / 19,9 lt	€ 72,00
MOD. 1/1 EST. 530 x 325 INT. 500 x 300		GNT 11200	200 h / 30 lt	€ 66,00
		GNT 11150	150 h / 20,6 lt	€ 53,00
		GNT 11100	100 h / 13,3 lt	€ 40,00
		GNT 1165	65 h / 8,5 lt	€ 30,00
MOD. 2/3 EST. 352 x 325 INT. 329 x 300		GNT 23200	200 h / 19,3 lt	€ 44,00
		GNT 23150	150 h / 13,6 lt	€ 37,00
		GNT 23100	100 h / 8,9 lt	€ 30,00
		GNT 2365	65 h / 5,5 lt	€ 25,00
MOD. 1/2 EST. 325 x 265 INT. 300 x 238		GNT 12200	200 h / 11,6 lt	€ 42,00
		GNT 12150	150 h / 9,9 lt	€ 33,00
		GNT 12100	100 h / 8 lt	€ 25,00
		GNT 1265	65 h / 4,2 lt	€ 19,00



TEGLIE CON FONDO FORATO - PANS WITH PERFORATED BOTTOM

dimensioni in mm - dimension in mm

MOD. 2/1 EST. 646 x 530 INT. 620 x 500		GNF 2120	20 h / 6,5 lt	€ 41,00
		GNF 2140	40 h / 12 lt	€ 45,00
		GNF 2165	65 h / 18,9 lt	€ 54,00
MOD. 1/1 EST. 530 x 325 INT. 500 x 300		GNF 1120	20 h / 2,5 lt	€ 20,00
		GNF 1140	40 h / 5,5 lt	€ 22,00
		GNF 1165	65 h / 8,5 lt	€ 26,00
MOD. 2/3 EST. 352 x 325 INT. 329 x 300		GNF 2320	20 h / 1,8 lt	€ 15,00
		GNF 2340	40 h / 3,5 lt	€ 18,00
		GNF 2365	65 h / 5,5 lt	€ 20,00
MOD. 1/2 EST. 325 x 265 INT. 300 x 238		GNF 1220	20 h / 1,2 lt	€ 12,00
		GNF 1240	40 h / 2,5 lt	€ 14,00
		GNF 1265	65 h / 4,2 lt	€ 16,00

Bacinele gastronorm e vaschette per gelato AISI 304 (18/10) - GN basins and ice cream drums AISI 304 (18/10)
Bacs Gastronom et bacs à glace AISI 304 (18/10) - Gastronom Schüssel und Eisschalen AISI 304 (18/10)



VASCHE PER GELATO - BASINS FOR ICE-CREAM - BACS POUR GLACE - SCHALEN FÜR EIS

dimensioni in mm - dimension in mm

	VG 261612	260x165x120 h	3,5 lt	€ 20,00
	VG 261615	260x165x150 h	4,1 lt	€ 23,00
	VG 33168	330x165x80 h	3,5 lt	€ 20,00
	VG 331612	330x165x120 h	5 lt	€ 23,00
	VG 331615	330x165x150 h	6,5 lt	€ 24,00
	VG 36168	360x165x80 h	3,8 lt	€ 18,00
	VG 361612	360x165x120 h	5,4 lt	€ 19,00
	VG 361615	360x165x150 h	7,1 lt	€ 23,00
	VG 361618	360x165x180 h	8,8 lt	€ 26,00
	VG 36258	360x250x80 h	5 lt	€ 20,00
	VG 362512	360x250x120 h	8 lt	€ 21,00
	CR	Pozzetto inox per gelato - Stainless steel washers for ice - Crem portion		

TEGLIE SMALTATE - ENAMEL TRAY GN 1/1

	GNS 1120	GN 1/1 h 20	€ 63,00
	GNS 1140	GN 1/1 h 40	€ 70,00
	GNS 1165	GN 1/1 h 65	€ 74,00

COPERCHI IN PLASTICA - PLASTIC COVERS - COUVERCLES EN PLASTIQUE - DECKEL AUS PLASTIK

dimensioni in mm - dimension in mm

	CP 2	265x160	€ 9,00
	CP 3	330x165	€ 9,00
	CP 4	360x165	€ 9,00

SPATOLA PER GELATO / SPATULE FOR ICE-CREM

	SPG	Spatola trasparente, rossa, blu, gialla - Manico 26 cm.a	€ 6,00

Bacinelle gn in policarbonato - GN pans in polycarbonate
Bacs GN en polycarbonate - GN Polycarbonatbehälter







dimensioni in mm - dimension in mm

MOD. 1/1 EST. 530 x 325 INT. 500 x 300		GNP 11200	200 h / 30 lt	€ 25,00
		GNP 11150	150 / 20,6 lt	€ 21,00
		GNP 11100	100 / 13,3 lt	€ 17,00
		GNP 1165	65 h / 8,5 lt	€ 14,00
		COPP 11	530x325	€ 10,00
		GFP 11	460x255	€ 8,00
MOD. 1/2 EST. 325 x 265 INT. 300 x 238		GNP 12200	200 h / 11,6 lt	€ 15,00
		GNP 12150	150 / 9,9 lt	€ 13,00
		GNP 12100	100 h / 8 lt	€ 10,00
		GNP 1265	65 h / 4,2 lt	€ 8,00
		COPP 12	325x265	€ 7,00
		GFP 12	250x190	€ 5,00
MOD. 1/3 EST. 325 x 176 INT. 300 x 150		GNP 13200	200 h / 8,1 lt	€ 12,00
		GNP 13150	150 h / 5,9 lt	€ 10,00
		GNP 13100	100 h / 3,8 lt	€ 8,00
		GNP 1365	65 h / 2,5 lt	€ 6,00
		COPP 13	325x176	€ 5,00
		GFP 13	250x110	€ 3,00
MOD. 1/4 EST. 265 x 162 INT. 238 x 136		GNP 14200	200 h / 4,9 lt	€ 11,00
		GNP 14150	150 / 4,1 lt	€ 8,00
		GNP 14100	100 h / 2,5 lt	€ 6,00
		GNP 1465	65 h / 1,9 lt	€ 5,00
		COPP 14	265x162	€ 3,00
		GFP 14	210x110	€ 3,00
MOD. 1/6 EST. 176 x 162 INT. 140 x 153		GNP 16200	200 h / 3,1 lt	€ 8,00
		GNP 16150	150 / 2,5 lt	€ 6,00
		GNP 16100	100 h / 1,6 lt	€ 5,00
		GNP 1665	65 h / 1,1 lt	€ 4,00
		COPP 16	176x162	€ 3,00
		GFP 16	115x100	€ 2,00
MOD. 1/9 EST. 176 x 108 INT. 140 x 100		GNP 19100	100 h / 0,9 lt	€ 4,00
		GNP 1965	65 h / 0,5 lt	€ 3,00
		COPP 19	176x100	€ 3,00





CASSETTA SEMIFORATA

dimensioni in mm - dimension in mm

	AV4908	60x40x10 h - lt. 18	€ 12,00





-  **MORSA PER PROSCIUTTO.** Corpo in acciaio inox. Supporto e manici in legno pregiato.
-  **HAM VICE.** Stainless steel body. Fine wooden base and handles.
-  **ETAU POUR JAMBON.** Corps en acier inoxydable. Base et poignées en bois.
-  **SCHINKEN-EINSPANNUNG.** Gestell aus rostfreiem Stahl. Sockel und Handgriffe aus Holz.



-  **MORSA PER PROSCIUTTO.** Corpo in acciaio. Supporto e manici in legno.
-  **HAM VICE.** Steel body, wooden support and handles.
-  **ETAU POUR JAMBON.** Corps en acier inox. Support et manches en bois.
-  **SCHINKEN-EINSPANNUNG.** Gestell aus Stahl, Halterung und Griffe aus Holz.



AV 4515 **€ 45,00**

-  **VASSOIO IN LAMINATO.** Disponibile solo in colore teak.
-  **LAMINATED MELAMINE TRAYS.** Available in teak version only.
-  **PLATEAUX STATIFIÉS EN MÉLAMINE.** Disponible seulement en version teak.
-  **TABLETTS AUS KUNSTSTOFF.** Verfügbar aus teak.



AV 4585 **€ 18,00**

Gastronorm teak 53x32,5

AV 4586 **€ 19,00**

Euronorm teak 53x37

AV 4587 **€ 20,00**

Esagonale teak 52x34,5

AV 4510 **€ 140,00**
 DIMENSIONI ESTERNE - EXTERNAL DIMENSIONS LxPxH cm **58x25x19 h**
 DIMENSIONS EXTERIEURES - AUßENABMESSUNGEN LxPxH cm



-  **APRISCATOLE DA BANCO.** Apparecchiatura in acciaio cementato. Coltello in acciaio inox. Alzacoperchi magnetico.
-  **TABLE TOP CAN OPENER.** Case-hardened steel appliance. Stainless steel knife. Magnetic cover lifter.
-  **OUVRE-BOÎTES DE TABLE.** Appareil en acier cémenté. Couteau en acier inoxydable. Soulèvement magnétique du couvercle.
-  **DOSENÖFFNER.** Gerät aus einsatzgehartetem Stahl. Messer aus rostfreiem Stahl. Magnetische Deckelhebung.

AV 4500 **€ 98,00**
 DIMENSIONI ESTERNE - EXTERNAL DIMENSIONS LxPxH cm **10x23x69 h**
 DIMENSIONS EXTERIEURES - AUßENABMESSUNGEN LxPxH cm

Bilancia elettronica - Electronic scale Bilance électronique - Elektronische Waage

 BILANCIA ELETTRONICA KG 15 DIV. GR. 5. Corpo in materiale ABS. Piatto inox dim. 28x21. Alimentazione a batteria ricaricabile 230V 7W. Peso bilancia (batterie escluse) kg 4,1. Bolla di livello incorporata. Tastiera con protezione antispruzzo. Acquisizione tara. **Non adatta per la vendita al pubblico.**

 ELECTRONIC SCALE 15 KOS DIV. 5 GR. Body in ABS. Stainless steel plate 28x21 cm. Power supply 230V 7W with rechargeable batteries. Scale weight (batteries excluded) 4,1 kos. Incorporated level ball of air. Anti-sprinkling protection keyboard. **Tare acquisition. Not for retail sale.**



 BILANCE ÉLECTRONIQUE KG 15 DIV. GR 5. Corps en ABS. Plateau en acier inox 28x21 cm. Alimentation à batteries rechargeables 230V 7W. Poids de la balance (batteries exclues) 4,1 kg. Bulle de niveau incorporée. Clavier avec protection anti-éclaboussures. Acquisition de la tare. **Ce produit n'est pas destiné à la vente au détail.**

 ELEKTRONISCHE WAAGE 15 KG TRENN. GR 5. Gehäuse aus ABS. Waageschale aus rostfreier Stahl 28x21 cm. Speisung mit wiederaufladbare Batterien 230V 7W. Gewicht (ohne Batterien) 4,1 kg. Luftblase für das Niveau inbegriffen. Tastatur mit Spritzer-schutz. Taraerwerbung. **Nicht geeignet für den Einzelverkauf.**

BL 4545

€ 250,00

DIMENSIONI ESTERNE - EXTERNAL DIMENSIONS LxPxH cm

DIMENSIONS EXTERIEURES - AUBENABMESSUNGEN LxPxH cm

29x33x22 h



 BILANCIA ELETTRONICA KG 60 DIV. gr. 20. Piatto inox dim. 32x33. Display remoto cavo cm 150. Alimentazione a batteria + alimentatore 230V 2W. Peso bilancia (batterie escluse) kg 4,5. Acquisizione tara. **Non adatta per la vendita al pubblico.**

 ELECTRONIC SCALE 60 KOS DIV. 20 GR. Stainless steel plate 32x33 cm. Remote display with cable 150 cm. Power supply with battery + feeder 230V 2W. Scale weight (batteries excluded) 4,5 kos. **Tare acquisition. Not for retail sale.**

 BILANCE ÉLECTRONIQUE KG 60 DIV. GR 20. Plateau en acier inox 32x33 cm. Remote display avec cable cm 150. Alimentation avec batterie + alimentateur 230V 2W. Poids de la balance (batteries exclues) 4,5 kg. Acquisition de la tare. **Ce produit n'est pas destiné à la vente au détail.**

 ELEKTRONISCHE WAAGE 60 KG TRENN. GR 20. Waageschale aus rostfreier Stahl 32x33 cm. Remote display mit Kabel cm 150. Speisung mit Batterie + Speiseleistung 230V 2W. Taraerwerbung. **Nicht geeignet für den Einzelverkauf.**

BP 4548

€ 190,00

DIMENSIONI ESTERNE - EXTERNAL DIMENSIONS LxPxH cm

DIMENSIONS EXTERIEURES - AUBENABMESSUNGEN LxPxH cm

31x30x5 h

Accessori per pizzeria - Accessories for pizzeria
Accessoires pour pizzeria - Zubehör für Pizzerien



Pala in alluminio forata professionale
 Professional perforated aluminium paddle
 Pale en aluminium percée professionnel
 Lochschaufel aus Aluminium für professionellen Gebrauch

AV 4960 € 132,00

DIMENSIONI ESTERNE - EXTERNAL DIMENSIONS LxPxH cm
 DIMENSIONS EXTERIEURES - AUßENABMESSUNGEN LxPxH cm **33x33x170 h**

AV 4961 € 148,00

DIMENSIONI ESTERNE - EXTERNAL DIMENSIONS LxPxH cm
 DIMENSIONS EXTERIEURES - AUßENABMESSUNGEN LxPxH cm **36x36x170 h**

AV 4962 € 173,00

DIMENSIONI ESTERNE - EXTERNAL DIMENSIONS LxPxH cm
 DIMENSIONS EXTERIEURES - AUßENABMESSUNGEN LxPxH cm **45x45x170 h**

AV 4963 € 182,00

DIMENSIONI ESTERNE - EXTERNAL DIMENSIONS LxPxH cm
 DIMENSIONS EXTERIEURES - AUßENABMESSUNGEN LxPxH cm **50x50x170 h**



Pala in alluminio professionale
 Professional aluminium paddle
 Pale Alluminium professionnel
 Schaufel aus Aluminium für professionellen Gebrauch

AV 4926 € 118,00

DIMENSIONI ESTERNE - EXTERNAL DIMENSIONS LxPxH cm
 DIMENSIONS EXTERIEURES - AUßENABMESSUNGEN LxPxH cm **33x33x170 h**

AV 4927 € 132,00

DIMENSIONI ESTERNE - EXTERNAL DIMENSIONS LxPxH cm
 DIMENSIONS EXTERIEURES - AUßENABMESSUNGEN LxPxH cm **36x36x170 h**

AV 4930 € 158,00

DIMENSIONI ESTERNE - EXTERNAL DIMENSIONS LxPxH cm
 DIMENSIONS EXTERIEURES - AUßENABMESSUNGEN LxPxH cm **45x45x170 h**

AV 4930/50 € 165,00

DIMENSIONI ESTERNE - EXTERNAL DIMENSIONS LxPxH cm
 DIMENSIONS EXTERIEURES - AUßENABMESSUNGEN LxPxH cm **50x50x170 h**



Pala in alluminio per forni elettrici e a gas
 Aluminium paddle for electric and gas ovens
 Pale aluminium pour fours électriques et à gas
 Schaufel aus Aluminium für elektrische und Gasöfen

AV 4965 € 44,00

DIMENSIONI ESTERNE - EXTERNAL DIMENSIONS LxPxH cm
 DIMENSIONS EXTERIEURES - AUßENABMESSUNGEN LxPxH cm **33x35x70 h**



Pala in alluminio - Aluminium paddle
 Pale Alluminium - Schaufel aus Aluminium

AV 4925 € 75,00

DIMENSIONI ESTERNE - EXTERNAL DIMENSIONS LxPxH cm
 DIMENSIONS EXTERIEURES - AUßENABMESSUNGEN LxPxH cm **33x33x135 h**

AV 4928 € 90,00

DIMENSIONI ESTERNE - EXTERNAL DIMENSIONS LxPxH cm
 DIMENSIONS EXTERIEURES - AUßENABMESSUNGEN LxPxH cm **33x33x170 h**

AV 4929 € 96,00

DIMENSIONI ESTERNE - EXTERNAL DIMENSIONS LxPxH cm
 DIMENSIONS EXTERIEURES - AUßENABMESSUNGEN LxPxH cm **36x36x170 h**



Palino in acciaio forato - Perforated steel small paddle
 Petit pale pércées en acier - Kleine lochschaufel aus Stahl

AV 4922 € 90,00

DIMENSIONI ESTERNE - EXTERNAL DIMENSIONS LxPxH cm
 DIMENSIONS EXTERIEURES - AUßENABMESSUNGEN LxPxH cm **Ø 18x170 h**

AV 4923 € 95,00

DIMENSIONI ESTERNE - EXTERNAL DIMENSIONS LxPxH cm
 DIMENSIONS EXTERIEURES - AUßENABMESSUNGEN LxPxH cm **Ø 22x170 h**

AV 4968 € 100,00

DIMENSIONI ESTERNE - EXTERNAL DIMENSIONS LxPxH cm
 DIMENSIONS EXTERIEURES - AUßENABMESSUNGEN LxPxH cm **Ø 26x170 h**



Palino in acciaio - Steel small paddle
 Petit pale en acier - Kleine Schaufel aus Stahl

AV 4920 € 82,00

DIMENSIONI ESTERNE - EXTERNAL DIMENSIONS LxPxH cm
 DIMENSIONS EXTERIEURES - AUßENABMESSUNGEN LxPxH cm **Ø 18x170 h**

AV 4921 € 86,00

DIMENSIONI ESTERNE - EXTERNAL DIMENSIONS LxPxH cm
 DIMENSIONS EXTERIEURES - AUßENABMESSUNGEN LxPxH cm **Ø 22x170 h**



Paletta per cenere - Pan for Ash
 Pelle à cendre - Aschenschaufel

AV 4911 € 78,00

DIMENSIONI ESTERNE - EXTERNAL DIMENSIONS LxPxH cm
 DIMENSIONS EXTERIEURES - AUßENABMESSUNGEN LxPxH cm **170 h**

Accessori per pizzeria - Accessories for pizzeria
Accessoires pour pizzeria - Zubehör für Pizzerien



Kit 3 pezzi h.170 (pala ø33 - palino ø18 - spazzola)
 Set of 3 pieces. h.170 (paddle ø33 - small paddle ø18 - brush)
 Set de 3 pièces h.170 (pale ø33 - palette ø18 - brosse)
 Set aus drei Stücke h.170 (Schaufel ø33 - kleine Schaufel ø18 - Bürste)

AV 4970 € 188,00

DIMENSIONI ESTERNE - EXTERNAL DIMENSIONS LxPxH cm **170 h**
 DIMENSIONS EXTERIEURES - AUBENABMESSUNGEN LxPxH cm



Kit 3 pezzi h.135 (pala ø33 - palino ø22 - spazzola)
 Set of 3 pieces. h.135 (paddle ø33 - small paddle ø22 - brush)
 Set de 3 pièces h.135 (pale ø33 - petit pale ø22 - brosse)
 Set aus drei Stücke h.135 (Schaufel ø33 - kleine Schaufel ø22 - Bürste)

AV 4972 € 144,00

DIMENSIONI ESTERNE - EXTERNAL DIMENSIONS LxPxH cm **135 h**
 DIMENSIONS EXTERIEURES - AUBENABMESSUNGEN LxPxH cm



Pala per pizza metro
 Paddle for meter pizza
 Pale pour pizza au mètre
 Schaufel für Meterpizza

AV 4966 € 174,00

DIMENSIONI ESTERNE - EXTERNAL DIMENSIONS LxPxH cm **60x40x170h**
 DIMENSIONS EXTERIEURES - AUBENABMESSUNGEN LxPxH cm



Tagliere polietilene per pizza
 Chopping board in polyethylene for pizza
 Planches à hacher en polyethylene pour pizza
 Hackbrette aus Polyäthlen

AV 4935 € 45,00

DIMENSIONI ESTERNE - EXTERNAL DIMENSIONS LxPxH cm **Ø 35**
 DIMENSIONS EXTERIEURES - AUBENABMESSUNGEN LxPxH cm

AV 4936 € 60,00

DIMENSIONI ESTERNE - EXTERNAL DIMENSIONS LxPxH cm **Ø 40**
 DIMENSIONS EXTERIEURES - AUBENABMESSUNGEN LxPxH cm



Spazzola ottone girevole a mezzaluna - Brass rotating brush, half-moon shaped
 Brosse en laiton tournante, à demi-lune - Drehalmondbürste aus Messing

AV 4959 € 100,00

DIMENSIONI ESTERNE - EXTERNAL DIMENSIONS LxPxH cm **170 h**
 DIMENSIONS EXTERIEURES - AUBENABMESSUNGEN LxPxH cm



Spazzola in fibra naturale - Brush in natural fibre
 Brosse en fibrage naturelle - Bürste aus naturreim Faser

AV 4912 € 68,00

DIMENSIONI ESTERNE - EXTERNAL DIMENSIONS LxPxH cm **170 h**
 DIMENSIONS EXTERIEURES - AUBENABMESSUNGEN LxPxH cm

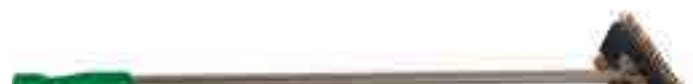

Spazzola doppia inox/ottone con raschietto
 Stainless steel/brass double brush with scraper
 Double brosse inox/laiton avec grattoir
 Doppelbürste Edelstahl/Messing mit Schaber

AV 4971 € 46,00

DIMENSIONI ESTERNE - EXTERNAL DIMENSIONS LxPxH cm **110 h**
 DIMENSIONS EXTERIEURES - AUBENABMESSUNGEN LxPxH cm



Spazzola in ottone per forni a legna - Brass brush for wood-fired ovens
 Brosse en laiton pour fours à bois - Bürste aus Messing für Holz Öfen

AV 4919 € 86,00

DIMENSIONI ESTERNE - EXTERNAL DIMENSIONS LxPxH cm **170 h**
 DIMENSIONS EXTERIEURES - AUBENABMESSUNGEN LxPxH cm



Tagliere legno multistrato
 Multilayer wood chopping board
 Planche en bois multicouches
 Hackbrette aus Multischichtholz

AV 4776 € 39,00

DIMENSIONI ESTERNE - EXTERNAL DIMENSIONS LxPxH cm **Ø 33**
 DIMENSIONS EXTERIEURES - AUBENABMESSUNGEN LxPxH cm

AV 4777 € 56,00

DIMENSIONI ESTERNE - EXTERNAL DIMENSIONS LxPxH cm **Ø 45**
 DIMENSIONS EXTERIEURES - AUBENABMESSUNGEN LxPxH cm

Accessori per pizzeria - Accessories for pizzeria
Accessoires pour pizzeria - Zubehör für Pizzerien

Paletta servipizza in acciaio
 Pan for pizzas serving
 Palette pour le desservir de pizzas
 Schaufel zur Bedienung von Pizza



AV4931

AV 4905 € 72,00

DIMENSIONI ESTERNE - EXTERNAL DIMENSIONS LxPxH cm
 DIMENSIONS EXTERIEURES - AUßENABMESSUNGEN LxPxH cm **Ø 50 a 8 porzioni**

AV 4931 € 46,00

DIMENSIONI ESTERNE - EXTERNAL DIMENSIONS LxPxH cm
 DIMENSIONS EXTERIEURES - AUßENABMESSUNGEN LxPxH cm **Ø 33**

Retina tonda inox
 Round little net in s/s
 Résille ronde en acier inox
 Rund Kleines Netz aus rostfreiem Stahl



AV 4951 € 21,00

DIMENSIONI ESTERNE - EXTERNAL DIMENSIONS LxPxH cm
 DIMENSIONS EXTERIEURES - AUßENABMESSUNGEN LxPxH cm **Ø 28**

AV 4952 € 23,00

DIMENSIONI ESTERNE - EXTERNAL DIMENSIONS LxPxH cm
 DIMENSIONS EXTERIEURES - AUßENABMESSUNGEN LxPxH cm **Ø 33**

AV 4953 € 35,00

DIMENSIONI ESTERNE - EXTERNAL DIMENSIONS LxPxH cm
 DIMENSIONS EXTERIEURES - AUßENABMESSUNGEN LxPxH cm **Ø 45**

Retina tonda alluminio
 Round little net in aluminium
 Résille ronde en alluminium
 Round Kleines Netz aus Aluminium



AV 4955 € 12,00

DIMENSIONI ESTERNE - EXTERNAL DIMENSIONS LxPxH cm
 DIMENSIONS EXTERIEURES - AUßENABMESSUNGEN LxPxH cm **Ø 28**

AV 4956 € 16,00

DIMENSIONI ESTERNE - EXTERNAL DIMENSIONS LxPxH cm
 DIMENSIONS EXTERIEURES - AUßENABMESSUNGEN LxPxH cm **Ø 33**

AV 4957 € 21,00

DIMENSIONI ESTERNE - EXTERNAL DIMENSIONS LxPxH cm
 DIMENSIONS EXTERIEURES - AUßENABMESSUNGEN LxPxH cm **Ø 45**

Paletta inox per pizza triangolare 15x25 cm
 Scoop in s/s for triangular pizza
 Palette en acier inox pour pizza triangulaire
 Stemple aus rostfreiem Stahl für dreieckige Pizza

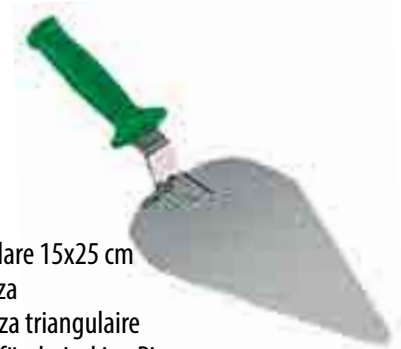

AV 4948 € 39,00

Paletta inox per pizza 10x15 cm
 Stainless steel paddle for pizza 10x15 cm
 Pale en acier inox pour pizza 10x15 cm
 Schaufel aus Edelstahl für Pizza 10x15 cm



AV 4954 € 23,00

Spatola in acciaio inox 10 cm
 Scoop in s/s 10 cm
 Raclette en acier inox 10 cm
 Spachtel aus rostfreiem Stahl 10 cm



AV 4932 € 14,00

Pinza prenditeglie
 Plier for backin-tins
 Pincés prend-plat
 Zange zum Backform



AV 4941 € 34,00

Bucasfoglia in lega
 Pastry-perforating roller
 Perce-abaisse
 Ausgeroller Teig Lochgrädchen



AV 4933 € 62,00

Accessori per pizzeria - Accessories for pizzeria
Accessoires pour pizzeria - Zubehör für Pizzerien

Rotella taglia pizza Ø mm 90
 Pizza cutting wheel Ø mm 90
 Molette coupe pizza Ø mm 90
 Grädchen zur Pizza schneiden Ø mm 90



AV 4934 € 19,00

Rotella professionale taglia pizza
 Ø mm 90
 Professional Pizza cutting wheel Ø mm 90
 Molette professionnelle coupe pizza Ø mm 90
 Grädchen für Pizza Ø mm 90



AV 4949 € 59,00

Raschietto inox cm 12
 Brush in s/s cm 12
 Grattoir en acier inox cm 12
 Shaber aus rostfreiem Stahl cm 12



AV 4946 € 16,00

Oliera in acciaio inox 0,75 lt.
 Cruet in s/s 0,75 lt.
 Huilier en acier inox 0,75 lt.
 Ölflasche aus rostfreiem Stahl 0,75 lt.



AV 4942 € 73,00

Contenitore per impasti pizza
 Stackable pizza dough container
 Conteneur pour le gâchage
 de pizza
 Behälter für Pizza Teigmasse



AV 4938 € 13,00

DIMENSIONI ESTERNE - EXTERNAL DIMENSIONS LxPxH cm
 DIMENSIONS EXTERIEURES - AUßENABMESSUNGEN LxPxH cm

60x40x7,5 h

AV 4967 € 15,00

DIMENSIONI ESTERNE - EXTERNAL DIMENSIONS LxPxH cm
 DIMENSIONS EXTERIEURES - AUßENABMESSUNGEN LxPxH cm

60x40x9 h

AV 4939 Coperchio per contenitore / Container lid. € 11,00

DIMENSIONI ESTERNE - EXTERNAL DIMENSIONS LxPxH cm
 DIMENSIONS EXTERIEURES - AUßENABMESSUNGEN LxPxH cm

60x40

Cassetta per appoggio pale
 Box holding paddles
 Cassette pour pales
 Schaufelkiste



AV 4916 € 59,00

Supporto reggipale a muro
 Wall holding paddle
 Support palettes à mur
 Wandschaufelträger



AV 4913 € 34,00

Supporto reggipale a muro
 Wall holding paddle
 Support palettes à mur
 Wandschaufelträger



AV 4914 € 50,00

Supporto reggipale
 Paddle support
 Support pour pales
 Schaufelträger



AV 4910 € 250,00

DIMENSIONI ESTERNE - EXTERNAL DIMENSIONS LxPxH cm
 DIMENSIONS EXTERIEURES - AUßENABMESSUNGEN LxPxH cm

150 h

Alare per appoggio legna
Andiron stand for firewood
Chenet pour appui bois
Alare als Holzstütze



AV 4918

€ 64,00



Borsa termica 5 pizze Ø33 per consegna a domicilio
Thermal bag 5 pizzas Ø33 for take-away
Borse calorifique pour 5 pizza Ø33 à apporter
Wärme Behälter zum Mitnehmen Ø33

AV 4975

€ 52,00

DIMENSIONI ESTERNE - EXTERNAL DIMENSIONS LxPxH cm
DIMENSIONS EXTERIEURES - AUßENABMESSUNGEN LxPxH cm

37x37x20



Piastra di fissaggio al portapacchi ciclomotore (per art. AV4973)
Fixing plate for motorbike package shelf (for item AV4973)
Plaque de montage pour porte-bagages du cyclomoteur (pour article AV4973)
Befestigungsplatte für Gepäckträger des Motorrads (für Artikel AV4973)

AV 4974

€ 68,00

DIMENSIONI ESTERNE - EXTERNAL DIMENSIONS LxPxH cm
DIMENSIONS EXTERIEURES - AUßENABMESSUNGEN LxPxH cm

35x37x6,5



Portapizze rigido, interno in alluminio, per trasporto 10 pizze Ø33
Box thermal bag holder for transport of 10 pizzas Ø33
Conteneur porte.sac thermique pour le transport de 10 pizza Ø33
Behälter mit wärmer Tasche um 10 Pizza Ø33 zu tragen

AV 4973

€ 270,00

DIMENSIONI ESTERNE - EXTERNAL DIMENSIONS LxPxH cm
DIMENSIONS EXTERIEURES - AUßENABMESSUNGEN LxPxH cm

47x47x52





Ceppi 
Copriceppo
Taglieri
Accessori per macelleria

Chopping Block 
Chopping Block Cover
Chopping boards
Butchery accessories

Souche 
Couvre Souche
Planches à hacher
Accessoires pour boucherie

Hackklotz 
Hackklotzdecke
Hackbrette
Metzgereibetriebe

Ceppi, taglieri e accessori - Chopping blocks, chopping boards and accessories Sabots, planches à hacher et accessoires - Hackov, Schneidebretter und Zubehör

-  Ceppo in legno di acacia. Trattato con vernice atossica e collanti ecologici (conformi alle norme vigenti) assemblato con innesti a pressione e internamente con inserti speciali in legno. Batticarne ecologico e riciclabile - Reversibile.
-  Acacia chopping-block treated with antitoxic paint and ecologic glues (in compliance with regulations) pressure clutch assembling. Special inside wooden insertions - Ecologic and recyclable meat-pounder - Reversible.
-  Sabot en bois d'acacia traité avec des vernis atoxiques et colles écologiques (conformément aux règlements en vigueur). Assemblé par embrayage à pression en à l'intérieur par l'introduction de pièces en bois. Battoir à viande recyclable et écologique. Reversible.
-  Hackov aus Akazienholz, ungiftiger Lach und ökologischer Kleber (den geltenden Normen entsperchend) mit auf Druck ansteckbaren Zusatz und mit speziellen, internen Holzeinlagen. Fleischklöpfer, ökologisch, recycle, und umkehrbar.



SPESSORE / THICKNESS 17 cm

CCL 1744	Ceppo + Sgabello 40x40x90 h	€ 400,00
CCL 1745	Ceppo + Sgabello 45x45x90 h	€ 450,00
CCL 1755	Ceppo + Sgabello 50x50x90 h	€ 530,00
CCL 1764	Ceppo + Sgabello 60x40x90 h	€ 530,00
CCL 1766	Ceppo + Sgabello 60x60x90 h	€ 700,00
CCL 1774	Ceppo + Sgabello 70x40x90 h	€ 585,00
CCL 1775	Ceppo + Sgabello 70x50x90 h	€ 700,00



SPESSORE / THICKNESS 25 cm

CCL 2544	Ceppo + Sgabello 40x40x90 h	€ 505,00
CCL 2555	Ceppo + Sgabello 50x50x90 h	€ 660,00
CCL 2564	Ceppo + Sgabello 60x40x90 h	€ 660,00
CCL 2566	Ceppo + Sgabello 60x60x90 h	€ 810,00
CCL 2574	Ceppo + Sgabello 70x40x90 h	€ 700,00
CCL 2575	Ceppo + Sgabello 70x50x90 h	€ 810,00
CCL 2577	Ceppo + Sgabello 70x70x90 h	€ 960,00







SPESSORE / THICKNESS 35 cm

CCL 3555	Ceppo + Sgabello 50x50x90 h	€ 810,00
CCL 3566	Ceppo + Sgabello 60x60x90 h	€ 1.000,00
CCL 3575	Ceppo + Sgabello 70x50x90 h	€ 1.000,00
CCL 3577	Ceppo + Sgabello 70x70x90 h	€ 1.250,00
CCL 3586	Ceppo + Sgabello 80x60x90 h	€ 1.250,00





Per ceppi, sgabelli o misure speciali, richiedere preventivo
For chopping blocks, supports or special dimensions, please ask for a quotation
Pour billots, escabeaux ou dimensions spéciales, veuillez nous demander un devis
Für Hackklötze, Hocker oder besondere Abmessungen, bitte um einen Voranschlag ansuchen

Ceppi, taglieri e accessori - Chopping blocks, chopping boards and accessories Sabots, planches à hacher et accessoires - Hackov, Schneidebretter und Zubehör

-  CEPPINO IN POLIETILENE 80 h mm CON SGABELLO IN TUBOLARE ACCIAIO INOX 500x500x800 h mm
-  POLYETHYLENE CHOPPING BLOCK 80 h mm WITH TUBULAR STAINLESS STEEL FRAME 500x500x800 h mm
-  SABOTS DE POLYTHÈNE 80 h mm AVEC CHASSIS EN TUBULAIRE EN ACIER INOXYDABLE 500x500x800 h mm
-  HACKKLOTZ AUS POLYÄTHYLEN 80 h mm MIT RAHMEN AUS ROSTFREIEM STAHL 500x500x800 h mm



CCP 8000	Ceppo + Sgabello 400x400x880 h	€ 340,00
CCP 8001	Ceppo + Sgabello 500x500x880 h	€ 435,00
CCP 8002	Ceppo + Sgabello 700x500x880 h	€ 530,00
CCP 8003	Ceppo + Sgabello 600x600x880 h	€ 510,00
CCP 8004	Ceppo + Sgabello 700x700x880 h	€ 620,00
CCP 8005	Ceppo + Sgabello 800x600x880 h	€ 610,00
CCP 8006	Ceppo + Sgabello 1000x500x880 h	€ 630,00

-  COPRICEPPO DI POLIETILENE BIANCO
-  CHOPPING BLOCK COVER IN POLYETHYLENE WHITE
-  COUVRE SOUCHE EN POLYTHÈNE BLANC
-  HACKKLOTZDECKE AUS POLYÄTHYLEN WEISS

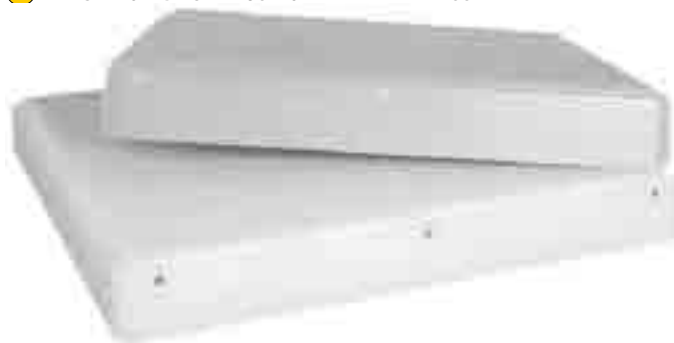

KCP 2501	400x400x25 h	€ 75,00
KCP 2502	500x500x25 h	€ 100,00
KCP 2503	600x400x25 h	€ 95,00
KCP 2504	600x600x25 h	€ 125,00
KCP 2505	700x400x25 h	€ 110,00
KCP 2506	700x500x25 h	€ 130,00
KCP 2508	700x700x25 h	€ 160,00





-  CEPPINO IN POLIETILENE ALIMENTARE BIANCO 80 h mm
-  WHITE POLYETHYLENE CHOPPING BLOCKS FOR FOOD 80 h mm



CPE 40408	Ceppo PE 400x400x80 h	€ 150,00
CPE 50508	Ceppo PE 500x500x80 h	€ 230,00
CPE 70508	Ceppo PE 700x500x80 h	€ 310,00
CPE 60608	Ceppo PE 600x600x80 h	€ 290,00
CPE 70708	Ceppo PE 700x700x80 h	€ 390,00
CPE 80608	Ceppo PE 800x600x80 h	€ 380,00
CPE 100508	Ceppo PE 1000x500x80 h	€ 390,00

Per sgabelli di ricambio richiedere preventivo
For spare supports, please ask for a quotation
Pour escabeaux de rechange, veuillez nous demander un devis
Für Ersatzhocker, bitte um einen Voranschlag ansuchen

Ceppi, taglieri e accessori - Chopping blocks, chopping boards and accessories Sabots, planches à hacher et accessoires - Hackov, Schneidebretter und Zubehör

-  TAGLIERI IN POLIETILENE
-  POLYETHYLENE CHOPPING BOARDS
-  PLANCHES À HACHER EN POLYTHÉNE
-  HACKBRETTE AUS POLYÄTHYLEN



TP 40302	40x30x2 h bianco/white	€ 25,00
TP 50302	50x30x2 h bianco/white	€ 29,00
TP 50402	50x40x2 h bianco/white	€ 39,00
TP 60402	60x40x2 h bianco/white	€ 47,00
TP 70402	70x40x2 h bianco/white	€ 55,00
TP 80402	80x40x2 h bianco/white	€ 61,00
TP 50302	50x30x2 h colorato: giallo, blu, marrone, rosso verde coloured: yellow, blue, brown, red, green	€ 31,00
TP 60402	60x40x2 h colorato: giallo, blu, marrone, rosso verde coloured: yellow, blue, brown, red, green	€ 50,00

Per scelta colore aggiungere al codice:

To choose the colour add to the code:

Pour choisir la couleur ajouter au code:

Für Farbwahl am Kode hinzufügen

Y = Giallo / Yellow / Jaune / Gelb

M = Marrone / Brown / Marron / Braun

G = Verde / Green / Vert / Grün

B = Blu / Blue / Bleu / Blau

R = Rosso / Red / Rouge / Rot

-  RASCHIETTO
-  BRUSH
-  BROSSE
-  REINIGUNGSBÜRSTE



RASK	Raschietto per pulizia ceppi e taglieri - Brush for chopping blocks and chopping boards cleaning	€ 30,00
RICRA	Ricambio lama per raschietto Blade spare part for the brush	€ 14,00



Sterilizzatori elettrici 
Accessori antinfortunistici
Lavamani
Scaffalatura modulare
Elettroinsetticidi a lampade UV-A



Electric sterilizers 
Safety accessories
Wash basins
Modular shelving
Ultraviolet ray bug lamp

Stérilisateurs électriques 
Accessoires de protection
Lave-mains
Rayonnage modulaire
Insecticide électrique à lampes UV-A

Elektrische Sterilisatoren 
Unfallschutz-Zubehör
Handwaschbecken
Bausteinregale
UV-A-Lampen-Insektenfänger

Sterilizzatori elettrici - Electric sterilizers Stérilisateurs électriques - Elektrische Sterilisatoren

-  Armadietto sterilizzatore a raggi UV costruito in acciaio inox Scotch Brite. Portina in plexiglas trasparente con microinterruttore. Portacoltelli in acciaio inox. Funzionamento con lampada germicida a UV 230 V 50/60 Hz 16W con griglia di protezione. Temporizzatore 60' e lampada spia di funzionamento. Cavo con spina.
-  UV sterilizer cupboard built in stainless steel scotch brite polished. Door in transparent perspex with safety microswitch. Germicide lamp UV 230 V 50/60 Hz 16W. Stainless steel knife holder with protection grid. Timer 60' with signal lamp. Cable with plug.

-  Armoire de sterilization UV en acier inox poli scotch brite. Porte en plexiglas transparent avec microinterrupteur de sécurité. Porte-couteaux en acier. Fonctionnement avec lampe germicide à UV 230 V 50/60 Hz 16W avec grille de protection. Minuterie 60' et lampe témoin. Cable avec prise.
-  Sterilizer Schrank UV aus Edelstahl. Tür ist aus durchsichtigen Plexiglas gebaut mit Mikroschalter. Messerhalter aus Edelstahl. Funktiostüchtigkeit mit Ultraviolettlampe 230 V 50/60 Hz 16W nakte-rientöntend und Sicherheitroste. Timer 60' mit Kontrollleuchte. Kabel mit Stecker.



Capacità 14 coltelli - Capacity 14 knives
Capacité 14 couteaux - Tragfähigkeit 14 Messer

SUV 14

€ 270,00

DIMENSIONI ESTERNE - EXTERNAL DIMENSIONS LxPxH cm
DIMENSIONS EXTERIEURES - AUßENABMESSUNGEN LxPxH cm

54x16x64 h



Capacità 10 coltelli - Capacity 10 knives
Capacité 10 couteaux - Tragfähigkeit 10 Messer





SUV 10

€ 250,00

DIMENSIONI ESTERNE - EXTERNAL DIMENSIONS LxPxH cm
DIMENSIONS EXTERIEURES - AUßENABMESSUNGEN LxPxH cm

43x16x64 h

Sterilizzatori elettrici e Antinfortunistica - Electric sterilizers and Safety Stérilisateur électriques et Protection - Elektrische Sterilisatoren und Unfallschutz

-  Sterilizzatori elettrici per coltelli. Struttura in acciaio inox 230 V 50/60Hz - Watt 1500. Termostato regolabile interno 30-110°C. Rubinetto di carico e scarico.
-  Electric knife sterilizers. Structure in stainless steel, 230 V 50/60 Hz - 1500 W, adjustable internal thermostat 30-110°C. Water loading un loading tap.
-  Stérilisateur électriques pour couteaux. Structure en acier inox 230 V 50/60 Hz - 1500 W. Thermostat interne réglable 30-110°C. Robinet d'introduction et dechargement d'eau.
-  Elektrische Sterilisatoren für Messer. Struktur aus Niro-Stahl. V 230 50/60 Hz - Watt 1500. Einstellbarer Innenthermostat für 30-110°C. Hahn zum Einleiten und entladen des Wassers.







Capacità 12 coltelli - Capacity 12 knives
Capacité 12 couteaux - Tragfähigkeit 12 Messer

SN 38 **€ 320,00**

DIMENSIONI ESTERNE - EXTERNAL DIMENSIONS LxPxH cm
DIMENSIONS EXTERIEURES - AUßENABMESSUNGEN LxPxH cm

38x14x40 h

-  Accessori antinfortunistici per macelleria.
-  Safety accessories for Butcheries.
-  Accessoires de protection pour la boucherie.
-  Unfallschutz-Zubehör für Metzgereibetriebe.



- 1) Grembiule alluminio antinfortunistico con bretelle
Aluminium safety apron with braces
Tablier aluminium de protection à bretelles
Unfallschutzkittel aus Aluminium mit Hosenträgern

AV 4897 **€ 150,00**

- 2) Grembiule acciaio inox antinfortunistico con bretelle
Stainless steel safety apron with braces
Tablier de protection acier inox à bretelles
Unfallschutzkittel aus Inox-Stahl mit Hosenträgern

AV 4898 **€ 180,00**

- 3) Avambraccio antinfortunistico in plexiglass misura standard
Standard size Plexiglas forearm protection
Avant-bras de protection en plexiglas taille standard
Unterarmschutz aus Plexiglas, Standardgröße

AV 4899 **€ 40,00**

- 4) Guanto inox antinfortunistico a cinque dita con cinturino inox completamente sterilizzabile
Completely cleansable stainless steel five fingered safety glove with stainless steel strap
Gant inox de protection à cinq doigts inox complètement stérilisable
Fünffinger-Schutzhandschuh mit Inox-Riemen, vollkommen sterilisierbar.

AV 4900 **€ 150,00**

- 5) Guanto inox antinfortunistico a cinque dita con chiusura a molla inox. Avambraccio compreso
Stainless steel five fingered safety glove with stainless steel spring strap. Forearm protection included
Gant inox de protection à cinq doigts avec fermeture à ressort inox. Avant-bras compris
Fünffinger-Schutzhandschuh mit Inox-Feder-Verschluss, einschließlich Unterarm.

AV 4901 **€ 270,00**

Lavamani - Wash basins

Lave-mains - Handwaschbecken

- 🇮🇹 Combinato lavamani più lava stracci inox con rubinetto acqua calda/fredda.
- 🇬🇧 Stainless steel combined hands and rags wash basin and with hot/cold water tap.
- 🇫🇷 Lave-mains et lave-chiffons en acier inox avec robinet eau chaude/froide.
- 🇩🇪 Gekoppeltes Handwasch- und Lumpenbecken aus Edelstahl mit Kalt- und Warmwasserhahn.



LMMC

€ 500,00

DIMENSIONI ESTERNE - EXTERNAL DIMENSIONS LxPxH cm
DIMENSIONS EXTERIEURES - AUßENABMESSUNGEN LxPxH cm

70x50x89 h

- 🇮🇹 Lavamani inox su mobile con porte a battente, comando a "ginocchio".
- 🇬🇧 Stainless steel wash bas with stand and pivot doors. Knee control.
- 🇫🇷 Lave-mains inox sur meuble avec portes battantes. Contrôle à genou.
- 🇩🇪 Handwaschbecken aus Inox mit Stand und Türen. Kniebefehl.



LMM

€ 450,00

DIMENSIONI ESTERNE - EXTERNAL DIMENSIONS LxPxH cm
DIMENSIONS EXTERIEURES - AUßENABMESSUNGEN LxPxH cm

50x40x85 h

- 🇮🇹 Lavamani - lavautensili inox su mobile con porta a battente. Con miscelatore acqua calda/fredda vasca da mm. 400x400x250
- 🇬🇧 Stainless steel hand and tools wash basin with stand and pivot doors. With hot/cold mixer tap - 400x400x250mm basin
- 🇫🇷 Lave-mains et lave-outils inox sur meuble avec portes battantes. Avec robinet mélangeur eau chaude/froide - lavabo 400x400x250mm
- 🇩🇪 Hand- und Küchen-gerätewashbecken aus Inox mit Stand und Drehflügeltür. Mit Kalt- und Warmwassermischhahn - Becken 400x400x250mm



LC 50 MM

€ 550,00

DIMENSIONI ESTERNE - EXTERNAL DIMENSIONS LxPxH cm
DIMENSIONS EXTERIEURES - AUßENABMESSUNGEN LxPxH cm

50x50x85 h

- 🇮🇹 Lavamani inox su mobile con porte a battente, comando a "ginocchio".
- 🇬🇧 Stainless steel wash bas with stand and pivot doors. Knee control.
- 🇫🇷 Lave-mains inox sur meuble avec portes battantes. Contrôle à genou.
- 🇩🇪 Handwaschbecken aus Inox mit Stand und Türen. Kniebefehl.

NEW







LM 48 M

€ 420,00

DIMENSIONI ESTERNE - EXTERNAL DIMENSIONS LxPxH cm
DIMENSIONS EXTERIEURES - AUßENABMESSUNGEN LxPxH cm

40x40x85 h

Lavamani - Wash basins Lave-mains - Handwaschbecken

-  Lavamani inox a colonna comando a "ginocchio".
-  Stainless steel wash basin column with pedal control "knee".
-  Lave-mains inox à colonne à commande à pédale "Genou".
-  Handwaschbecken aus Inox zur Befestigung an der Wand, "Knie"-Bedienungs pedal.







LC 50

€ 330,00

DIMENSIONI ESTERNE - EXTERNAL DIMENSIONS LxPxH cm
DIMENSIONS EXTERIEURES - AUßENABMESSUNGEN LxPxH cm

50x40x80 h

-  Lavamani inox a parete comando a "ginocchio".
-  Stainless steel wash basin column with pedal control "knee".
-  Lave-mains inox à fixation mural avec commande à pédale "Genou".
-  Handwaschbecken aus Inox zur Befestigung an der Wand, "Knie"-Bedienungs pedal.







LM 48

€ 310,00

DIMENSIONI ESTERNE - EXTERNAL DIMENSIONS LxPxH cm
DIMENSIONS EXTERIEURES - AUßENABMESSUNGEN LxPxH cm

48x35x53 h



-  Lavamani inox a parete comando a "ginocchio".
-  Stainless steel wash basin column with pedal control "knee".
-  Lave-mains inox à fixation mural avec commande à pédale "Genou".
-  Handwaschbecken aus Inox zur Befestigung an der Wand, "Knie"-Bedienungs pedal.

LM 40

€ 230,00

DIMENSIONI ESTERNE - EXTERNAL DIMENSIONS LxPxH cm
DIMENSIONS EXTERIEURES - AUßENABMESSUNGEN LxPxH cm

40x40x32 h

Scaffalatura modulare - Modular shelving

Rayonnage modulaire - Bausteinregale

La scaffalatura modulare nella versione in alluminio anodizzato rappresenta la soluzione ideale per l'immagazzinaggio nel rispetto delle norme d'igiene. L'ampia scelta di misure standard assicura una grande adattabilità ed un notevole risparmio di spazio. DESIGN RISPONDENTE ALLE NORME IGIENICHE. Le superfici lisce ed arrotondate, i profili chiusi, la totale assenza di spazi o fessure dove possa annidarsi lo sporco, permettono il mantenimento di un elevato standard di igiene. QUALITÀ DELLE LEGHE. La scaffalatura modulare per poter resistere all'usura prodotta da agenti chimici, termici e meccanici, è stata realizzata con leghe di alta qualità. A seconda delle specifiche esigenze, può essere richiesta nella versione di alluminio anodizzato (20 micron). Gli scaffali sono stati progettati per sopportare un alto carico con il minimo di flessione. UN SISTEMA PER TUTTI GLI USI. Le aree applicative della scaffalatura modulare sono molte: dal catering alle grandi cucine, dagli ospedali agli alberghi, dalle celle frigorifere ai magazzini in genere. Il sistema, per la sua grande versatilità, organizza e salva lo spazio in ogni ambiente. consentendo anche l'uso delle vaschette serie gastronorm (1/2 - 1/1 - 2/1 - 2/3) perfettamente inserite all'interno dei ripiani.

Ripiani in alluminio completi di griglie in polietilene
composti da: N° 2 fiancate, N° 4 attacchi, serie griglie.

Aluminum shelves equipped with polyethylene shelves
made up by: n° 2 longitudinal section bars, n° 4 joints, grid series.

Etagères en aluminium avec grilles en polyéthylène
munis de: n° 2 longerons, n° 4 attaches, série grilles.

Vollständige Aluminiumauflagen mit Polyäthylenrosten
bestehend aus: n° 2 Seitenverbindungen, n° 4 Anschlüssen, Serie Roste.

Either you choose the anodized aluminium version or the stainless steel version, modular shelving will always be the ideal solution for storage purposes in conformity the required hygiene rules. A wide choice of standard size components ensures great flexibility and space optimization. DESIGN CONFORMING TO HYGIENE RULES. Smooth surfaces, rounded-off corners, completely sealed units, total absence of gaps or crevices which could harbor organic matters ensure the maintenance of high hygiene standards in the long run. HIGH QUALITY ALLOYS. Modular shelving is exclusively manufactured from highquality alloys which make the shelving resistant to wear due the chemical agents, heat and mechanical stress. Depending on your needs, you can choose between the anodized aluminum version (20 microns) or the stainless steel version (AISI 304). The shelves have been so designed and constructed as to bear heavy loads with minimum bending. A SYSTEM FOR ALL USE. The application areas of the modular shelving are various: from catering to the big kitchens, from hospitals to hotels, from cold stores to general stores. This system, for its great versatility, organizes and saves space in each room, allowing the use of the gastronorm containers (1/2 1/1 2/1 2/3) properly fitted into the shelves.



Giunzioni per angolo - Angle clamps
Joints pour angle - Eckverbindungen

GA 373	€ 20,00
DIMENSIONI ESTERNE - EXTERNAL DIMENSIONS mm DIMENSIONS EXTERIEURES - AUßENABMESSUNGEN mm	373

Testata completa con: n. 2 piantane, n. 3 traversini, n. 2 piedi, n. 2 tappi.
End side equipped with: n. 2 pedestals, n. 3 sleepers, n. 2 feet, n. 2 plugs.
Echelle munie de: n. 2 montants, n. 3 traverses, n. 2 pieds, n. 2 bouchons.
Vollständiges Seitenteil mit: n. 2 Streben, n. 3 Querteiler, n. 2 Füße, n. 2 Stopfen.

F 15	€ 76,00
DIMENSIONI ESTERNE - EXTERNAL DIMENSIONS mm DIMENSIONS EXTERIEURES - AUßENABMESSUNGEN mm	373x1550h

F 17	€ 76,00
DIMENSIONI ESTERNE - EXTERNAL DIMENSIONS mm DIMENSIONS EXTERIEURES - AUßENABMESSUNGEN mm	373x1700h

F 20	€ 84,00
DIMENSIONI ESTERNE - EXTERNAL DIMENSIONS mm DIMENSIONS EXTERIEURES - AUßENABMESSUNGEN mm	373x2000h

R 62	€ 45,00
DIMENSIONI ESTERNE - EXTERNAL DIMENSIONS mm DIMENSIONS EXTERIEURES - AUßENABMESSUNGEN mm	373x620
R 88	€ 54,00
DIMENSIONI ESTERNE - EXTERNAL DIMENSIONS mm DIMENSIONS EXTERIEURES - AUßENABMESSUNGEN mm	373x886
R 97	€ 57,00
DIMENSIONI ESTERNE - EXTERNAL DIMENSIONS mm DIMENSIONS EXTERIEURES - AUßENABMESSUNGEN mm	373x974
R 106	€ 60,00
DIMENSIONI ESTERNE - EXTERNAL DIMENSIONS mm DIMENSIONS EXTERIEURES - AUßENABMESSUNGEN mm	373x1062
R 115	€ 65,00
DIMENSIONI ESTERNE - EXTERNAL DIMENSIONS mm DIMENSIONS EXTERIEURES - AUßENABMESSUNGEN mm	373x1152
R 124	€ 68,00
DIMENSIONI ESTERNE - EXTERNAL DIMENSIONS mm DIMENSIONS EXTERIEURES - AUßENABMESSUNGEN mm	373x1240
R 133	€ 78,00
DIMENSIONI ESTERNE - EXTERNAL DIMENSIONS mm DIMENSIONS EXTERIEURES - AUßENABMESSUNGEN mm	373x1330
R 150	€ 79,00
DIMENSIONI ESTERNE - EXTERNAL DIMENSIONS mm DIMENSIONS EXTERIEURES - AUßENABMESSUNGEN mm	373x1505

Electroinsetticidi a lampade UV-A - Ultraviolet ray bug lamp **Insecticide électrique à lampes UV-A - UV-A-Lampen-Insektenfänger**

 Materiale alluminio. Potenza 30W. Lampade 2x15W. montaggio: orizzontale o verticale. Copertura 80 mq. Collante di ricambio CRS30.

 Material Aluminium. Power 30W. Lamps 2x15W. Assembling: horizontal or vertical. Coverage 80 mq. Extra adhesive paper CRS30.



SE30

€ 200,00

DIMENSIONI ESTERNE - EXTERNAL DIMENSIONS LxPxH cm
DIMENSIONS EXTERIEURES - AUßENABMESSUNGEN LxPxH cm

30x13x55 h

 Materiale inox. Potenza 30W. Lampade 2x15W. Montaggio sospesa/muro. Copertura 80mq. Collante di ricambio CR30.

 Stainless steel. Light output 30W. Tubes 2x15W. 3 ways mounting. Coverage 80smq. Glue board replacement CR30.

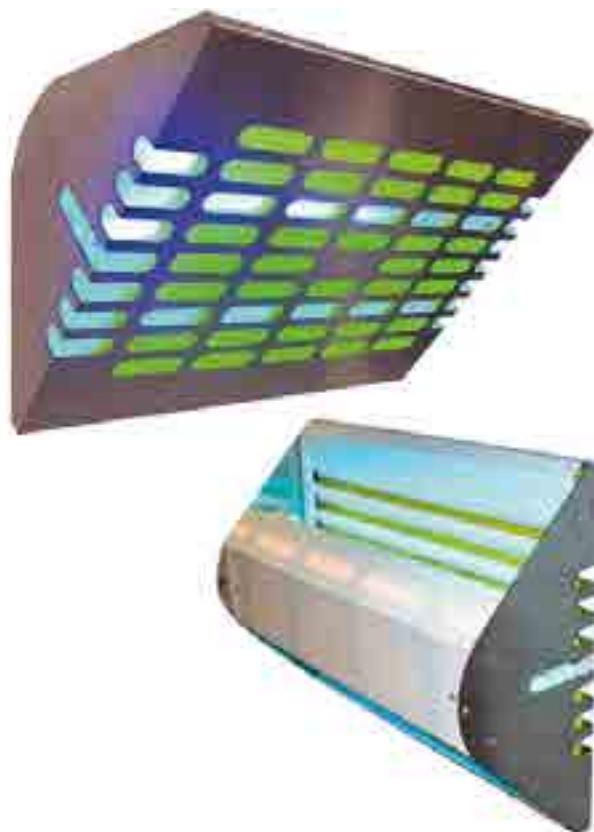

FT30

€ 210,00

DIMENSIONI ESTERNE - EXTERNAL DIMENSIONS LxPxH cm
DIMENSIONS EXTERIEURES - AUßENABMESSUNGEN LxPxH cm

47x19x36 h

 Materiale alluminio. Potenza 30W. Lampade 2x15W. Montaggio: a muro, ad angolo o appoggiato. Copertura

 Material Aluminium. Power 30W. Lamps 2x15W. Assembling: to the wall, in a corner or in support. Coverage 80 mq.



PZ30

€ 100,00

DIMENSIONI ESTERNE - EXTERNAL DIMENSIONS LxPxH cm
DIMENSIONS EXTERIEURES - AUßENABMESSUNGEN LxPxH cm

52x13x26 h

Ricambi - Spare parts

A 42	Spazzola ricambio in fibra naturale per AV4912	€ 18,00
A 43	Spazzola ricambio in ottone per AV4919	€ 21,00
A 45	Ricambio spazzolone ottone mezzaluna	€ 28,00
A 414	Barattolo lt. 1 lucido neutro per lucidascarpe	€ 20,00
A 520	Sacco in tela ignifugo per carrelli	€ 60,00
A 540	Ricambio MOP in cotone da gr. 400	€ 9,00
A 550	Pinza plastica gigante per MOP	€ 7,00
A 560	Manico legno verniciato Ø 24 - cm 150	€ 8,00
A 570	Strizzatore plastica con ingranaggi in plastica	€ 72,00
R 4501	Lama ricambio per apriscatole AV4500	€ 12,00
R 4502	Ingranaggio ricambio per apriscatole AV4500	€ 20,00
CR 30	Carta collante per FT 30 (confezione 6 pezzi)	€ 45,00
L 616	Lampada 15W per FT 30 / SE30	€ 10,00
L 617	Lampada 15W per PZ 30	€ 10,00
CRS30	Carta collante per SE30 (confezione 6 pezzi)	€ 34,00



CONDIZIONI GENERALI DI VENDITA

- **COSTO DELL'IMBALLO:** compreso nel prezzo per le macchine - ricambi ed accessori € 5,00.
- **PER ORDINI DI IMPORTO INFERIORE A € 80,00 COSTO FISSO GESTIONE ORDINI € 5,00.**
- **CONDIZIONI DI PAGAMENTO:** Si richiede il pagamento in contanti o in contrassegno: 1. per le prime forniture - 2. al superamento del fido - 3. per l'invio dei ricambi.
- **DILAZIONI DI PAGAMENTO:** da definire.
- **PREZZI:** non sono impegnativi, possono subire variazioni senza obbligo di preavviso, in tal caso saranno confermati all'ordine. **I PREZZI SONO ESCLUSI DI I.V.A.**
- **TERMINI DI CONSEGNA:** 1. spedizione giornaliera per macchine disponibili a magazzino - 2. per macchine da produrre circa 25 giorni salvo imprevisti.
- **ASSISTENZA TECNICA:** a carico del **RIVENDITORE** per tutta la durata della garanzia di anni uno. Forcar srl si impegna a fornire, in garanzia, tutti i componenti di ricambio ritenuti difettosi. Il prezzo di vendita fatturato all'utilizzatore finale comprenderà non solo il prezzo dei prodotti finiti venduti ma anche la gestione, da parte del rivenditore, della garanzia a copertura di essi. Forcar srl non dovrà sostenere alcuna spesa diretta o indiretta sostenuta dal rivenditore per la gestione della garanzia.
- **TRASPORTO FRANCO FABBRICA;** la merce viaggia a rischio e pericolo del committente, per cui non siamo responsabili per eventuali danni subiti dalla merce durante il trasporto. Eventuali contestazioni dovranno essere effettuate all'atto della consegna entro i termini di legge.
- **GARANZIA:** 12 mesi.
- **LISTINO:** il presente annulla tutti i precedenti. I dati tecnici e immagini riportati nel presente listino sono puramente indicativi. La Ditta si riserva il diritto di modificare le caratteristiche tecniche ed estetiche o sospendere, in ogni momento, la propria produzione senza obbligo di preavviso.
- **TUTTE LE NOSTRE MACCHINE SONO COPERTE DA ASSICURAZIONE (RESPONSABILITÀ CIVILE VERSO TERZI) ESCLUSO U.S.A. E CANADA**
- MOD089V03 - FINITO DI STAMPARE NEL SETTEMBRE 2015



GENERAL CONDITIONS OF SALE

- **COST OF PACKING:** included in price for machines. € 5,00 for spare parts and accessories.
- **FIXED HANDLING FEE OF € 5,00 FOR ORDERS OF LESS THAN € 80,00.**
- **CONDITIONS OF PAYMENT:** Cash payment or on delivery: 1. for first orders - 2. for orders in excess of granted credit - 3. for shipment of spare parts.
- **DEFERRED PAYMENTS:** to define.
- **PRICES** are not binding. They can be subjected to changes without prior advise. In anycase they will be defined by the order confirmation. **PRICES DO NOT INCLUDE VAT**
- **DELIVERY TIME:** 1. daily after receipt of orders for machines already available - 2. about 25 working days after receipt of orders for machines to be produced, subject to absence of unforeseen difficulties.
- **TECHNICAL ASSISTANCE:** provided by the **DEALER** for the entire duration of the **GUARANTEE**, (1 year). Forcar srl undertakes to provide, under warranty, all replacement parts considered defective. The sale price invoiced to the end user will include not only the price of the finished products sold, but also the management, by the dealer, of the warranty that covers them. Forcar srl will not incur any direct or indirect expenses incurred by the dealer for warranty management.
- **DELIVERY EX WORKS.** We are not responsible for any damage the goods can suffer during the transport: the goods are carried at the customer's own risk. Any eventual complaint must be reported within law terms.
- **WARRANTY:** 12 months.
- **PRICE LIST:** this price-list replaces all previous lists. The technical data and pictures illustrated in this price-list are only approximate. The manufacturer reserves the right to change technical and visual characteristics and to suspend production at any time without giving prior notice.
- **ALL OUR MACHINE ARE COVERED BY THE THIRD PARTY PRODUCT LIABILITY INSURANCE (U.S.A. AND CANADA EXCLUDED)**
- MOD089V03 - PRINTING COMPLETED IN SEPTEMBER 2015



CONDITIONS GENERALES DE VENTE

- **COÛT DE L'EMBALLAGE:** compris dans le prix pour les machines. € 5,00 pour les pièces de rechange et les accessoires.
- **POUR TOUTES COMMANDES INFÉRIEURES À € 80,00 COÛT FIXE DE GESTION DES COMMANDES DE € 5,00**
- **CONDITIONS DE PAIEMENT** - le paiement doit être effectué en argent comptant ou contre remboursement: 1. pour les premières fournitures - 2. au dépassement du crédit accordé - 3. pour l'envoi de pièces de rechange.
- **ECHEANCE DE PAIEMENT:** à définir.
- **PRIX:** ne sont pas définitifs, ils peuvent subir des variations sans obligation de préavis. Dans ce cas ils seront confirmés au moment de la commande. **LES PRIX NE COMPRENNENT PAS LA TVA**
- **DELAI DE LIVRAISON** 1. livraison journalière pour les machines disponibles - 2. alors que pour les machines à produire, à environ 25 jours ouvrables, sauf imprévis.
- **ASSISTANCE TECHNIQUE:** a la charge du **REVENDEUR** pour toute la durée de la **GARANTIE** (Une année). La société Forcar srl s'engage à fournir, en garantie, tous les composants de rechange considérés défectueux. Le prix de vente facturé à l'utilisateur final inclura le prix des produits finis vendus mais également la gestion, de la part du revendeur, de la garantie pour la couverture de ceux-ci. La société Forcar srl ne devra soutenir aucune dépense directe ou indirecte soutenue par le revendeur pour la gestion de la garantie.
- **TRANSPORT DEPART-USINE.** La marchandise voyage a risques et périls du client. La maison n'est pas responsable des éventuels dommages subis par la marchandise pendant le transport. Les éventuelles réclamations doivent être communiquées dans les délais de la loi.
- **GARANTIE:** 12 mois.
- **LISTE DES PRIX:** la présente liste annule tous les précédents. Les données techniques contenues dans la présente liste des prix et les photos sont purement indicatives. La maison se réserve le droit de modifier les caractéristiques techniques et esthétiques de ses articles ou d'en interrompre la production, à tout moment et sans obligation de préavis.
- **TOUTES NOS MACHINES SONT COUVERTES PAR UNE ASSURANCE (RESPONSABILITÉ CIVILE ENVERS TIERS)**
- MOD089V03 - ACHEVÉ D'IMPRIMER EN SEPTEMBRE 2015



ALLGEMEINE VERKAUFSBEDINGUNGEN

- **VERPACKUNGSKOSTEN:** im preis der maschinen inbegriffen. € 5,00 für ersatzteile und zubehöre.
- **FÜR BESTELLUNGEN UNTER € 80,00**
- **FIXE BEARBEITUNGS- GEBÜHR € 5,00.**
- **ZAHLUNGSBEDINGUNGEN** - Direktzahlung oder Zahlung bei Wareneingang wird verlangt: 1. für die erste lieferungen - 2. bei Überschreitung des gewährten Kredits - 3. für die Sendung von Ersatzteilen.
- **ZAHLUNGSZIEL:** Um zu bestimmen.
- **PREISE:** nicht verbindlich sind und können geändert sein ohne die Pflicht im Voraus zu benachrichtigen; in diesen Fall werden mit der Auftragbestätigung bestätigt sein. **DIE PREISE VERSTEHEN SICH AUSSCHLIESSLICH MWST LIEFERFRIST** 1. Täglich für verfügbare Maschinen - 2. für Maschinen um zu produzieren ungefähr 25 Arbeitstage, unvorhergesehene Umstände vorbehalten.
- **TECHNISCHER DIENST:** Zu lasten des **WIEDERVERKÄUFERS** während der gesamten Dauer der **GARANTIE** (1 Jahr). Forcar srl verpflichtet sich, während der Garantiezeit, zur Lieferung aller für defekt befundenen Ersatzteile. Der dem Endverbraucher in Rechnung gestellte Verkaufspreis umfasst nicht nur den Preis für die verkauften Endprodukte, sondern auch die Kosten für die Verwaltung der Garantie durch den Verkäufer. Forcar srl werden keine zusätzlichen direkten oder indirekten Kosten, die dem Verkäufer für die Verwaltung der Garantie entstehen, in Rechnung gestellt.
- **TRANSPORT FREI UNSEREM WERK.** Die Ware ist auf Gefahr der Auftraggeber transportiert, deshalb sind wir nicht verantwortlich für eventuelle Schaden der Ware während der Transport zugefügt. Eventuelle Anfechtungen sollen unbedingt nur nach den Gesetz gemacht sein.
- **GARANTIE:** 12 monate.
- **PREISLISTE:** Die vorliegende Preisliste setzt alle vorhergehenden außer Kraft. Die in der vorliegenden Preisliste angegebenen technischen Daten und die Fotos sind reine Richtwerte. Die Firma behält sich das Recht vor, die technischen oder ästhetischen Eigenschaften zu verändern oder die Produktion ohne Vorankündigung jederzeit einzustellen.
- **ALLE UNSERE MASCHINEN SIND VERSICHERUNGSGEDECKT (HAFTPFLICHT)**
- MOD089V03 - FERTIG GEDRUCKT IM SEPTEMBER 2015



CONDICIONES GENERALES DE VENTA

- **COSTE DEL EMBALAJE:** incluido en el precio para las máquinas - repuestos y accesorios 5,00 €
- **PARA PEDIDOS CON UN IMPORTE INFERIOR A 80,00 € COSTE FIJO GESTIÓN PEDIDOS 5,00 €**
- **CONDICIONES DE PAGO:** Se exige el pago en efectivo o contra reembolso: 1. para los primeros suministros - 2. cuando se supere el crédito - 3. para el envío de los repuestos.
- **APLAZAMIENTO DE PAGOS:** pendiente de definición.
- **PRECIOS:** no son vinculantes; pueden sufrir variaciones sin que la empresa esté obligada a avisar de ello previamente. En dicho caso, se confirmarán en el momento del pedido. **LOS PRECIOS NO INCLUYEN IVA.**
- **PLAZOS DE ENTREGA:** 1. envío diario para máquinas disponibles en el almacén - 2. 25 días aproximadamente, salvo imprevistos, para máquinas que deban fabricarse.
- **ASISTENCIA TÉCNICA:** A cargo del distribuidor durante todo el periodo de garantía (concretamente, 1 año). Forcar srl se compromete a suministrar, en garantía, todos los componentes de repuesto considerados defectuosos. El precio de venta facturado al usuario final incluirá no solo el precio de los productos acabados vendido, sino también la gestión, por parte del distribuidor, de la garantía que los cubre. Forcar srl no asumirá ningún gasto directo o indirecto soportado por el distribuidor por la gestión de la garantía.
- **TRANSPORTE FRANCO FÁBRICA:** la mercancía viaja por cuenta y riesgo del cliente; por tanto, no asumimos ninguna responsabilidad por los posibles daños que pueda sufrir la mercancía durante el transporte. Las reclamaciones deberán realizarse en el momento de la entrega y siempre respetando los términos legales.
- **GARANTÍA:** 12 meses
- **CATÁLOGO:** el presente catálogo anula todos los anteriores. Los datos técnicos y fotos incluidos en este catálogo son puramente indicativos. La Empresa se reserva el derecho a modificar las características técnicas y estéticas, o a suspender, en cualquier momento, su producción sin estar obligada a avisar previamente.
- **TODAS NUESTRAS MÁQUINAS ESTÁN CUBIERTAS POR SEGURO (RESPONSABILIDAD CIVIL Y DAÑOS A TERCEROS)**
- MOD089V03 - ACABADO DE IMPRIMIR EN SEPTIEMBRE DE 2015



CONDIÇÕES GERAIS DE VENDA

- **CUSTO DA EMBALAGEM:** incluído no preço de máquinas - peças e acessórios € 5,00.
- **PARA ENCOMENDAS COM VALOR INFERIOR A € 80,00, CUSTO FIXO DE GESTÃO DA ENCOMENDA € 5,00.**
- **CONDIÇÕES DE PAGAMENTO:** É solicitado o pagamento em dinheiro ou contra entrega: 1. para as primeiras entregas - 2. ao superar o crédito - 3. para o envio de peças de reposição.
- **DIFERIMENTOS DE PAGAMENTO:** a definir.
- **PREÇOS:** não são vinculantes, podem sofrer alterações sem obrigação de aviso prévio; nestes casos, serão confirmados com a encomenda. **OS PREÇOS SÃO INDICADOS SEM I.V.A.**
- **PRAZOS DE ENTREGA:** 1. expedição diária para máquinas disponíveis em estoque. 2. para máquinas a produzir, cerca de 25 dias, salvo imprevistos.
- **ASSISTÊNCIA TÉCNICA:** A cargo do revendedor durante toda a duração da garantia de um ano. A Forcar srl empenha-se em fornecer, sob garantia, todos os componentes de reposição considerados defeituosos. O preço de venda cobrado ao utilizador final compreenderá não apenas o preço dos produtos acabados vendidos, mas também a gestão, por parte do revendedor, da garantia de cobertura dos produtos. A Forcar srl não deverá arcar com nenhuma despesa, direta ou indireta, mantida pelo revendedor para a gestão da garantia.
- **TRANSPORTE FRANCO FÁBRICA:** a mercadoria viaja a risco e perigo do comitente, portanto não somos responsáveis por eventuais danos à mercadoria provocados durante o transporte. Quaisquer queixas deverão ser feitas no momento da entrega, dentro dos prazos legais.
- **GARANTIA:** 12 meses.
- **LISTA DE PREÇOS:** Esta lista anula toda as anteriores. Os dados técnicos indicados nesta lista são meramente indicativos. A Empresa reserva-se o direito de modificar as características técnicas e estéticas ou suspender, a qualquer momento, a sua produção sem obrigação de aviso prévio.
- **TODAS AS NOSSAS MÁQUINAS SÃO COBERTAS POR SEGURO (RESPONSABILIDADE CIVIL PERANTE TERCEIROS)**
- MOD089V03 - IMPRESSO EM SETEMBRO 2015



ОБЩИЕ УСЛОВИЯ ПРОДАЖИ

- **СТОИМОСТЬ УПАКОВКИ:** входит в цену для машин, запчастей и комплектующих € 5,00.
- **ДЛЯ ЗАКАЗОВ СТОИМОСТЬЮ МЕНЬШЕ € 80,00 ФИКСИРОВАННАЯ СТОИМОСТЬ ОБРАБОТКИ ЗАКАЗА € 5,00.**
- **УСЛОВИЯ ОПЛАТЫ:** требуется оплата наличными или наложенным платежом: 1. для первых поставок - 2. при превышении кредита - 3. для отправки запчастей.
- **ОТСРОЧКА ПЛАТЕЖА:** уточнить.
- **ЦЕНЫ:** не являются обязательными, могут меняться без обязательства уведомления, в данном случае будут подтверждены при оформлении заказа. **ЦЕНЫ УКАЗАНЫ БЕЗ НДС.**
- **УСЛОВИЯ ПОСТАВКИ:** 1. ежедневная отгрузка машин, имеющихся на складе - 2. в случае необходимости производства машины, 25 дней за исключением непредвиденных обстоятельств.
- **ТЕХНИЧЕСКАЯ ПОДДЕРЖКА:** За счёт дилера на время действия гарантии в течение одного года. Компания Forcar srl обязуется поставить, на условиях гарантии, все запасные компоненты, признанные дефектными. Фактурированная цена продажи конечному пользователю будет включать в себя не только цену готовой продукции, но также предоставление со стороны дилера гарантии. Forcar srl не примет на себя никакие расходы, прямые или косвенные, понесенные дилером на предоставление и выполнение условий гарантии.
- **ТРАНСПОРТИРОВКА ФРАНКО-ЗАВОД:** заказчик обязуется организовать должным образом перевозку товаров, поэтому мы не несем ответственности за любой ущерб, понесенный товаром во время транспортировки. Любые претензии должны быть предъявлены по факту поставки в срок, предусмотренный законодательством.
- **ГАРАНТИЯ:** 12 месяцев
- **ПЕРЕЧЕНЬ:** настоящий отменяет все предыдущие. Технические данные, приведенные в настоящем перечне, являются ориентировочными. Фирма оставляет за собой право изменять технические и эстетические характеристики или прервать производство в любой момент без обязательства уведомления.
- **ВСЕ НАШИ МАШИНЫ ПОКРЫТЫ ГАРАНТИЕЙ (ГРАЖДАНСКАЯ ОТВЕТСТВЕННОСТЬ ПЕРЕД ТРЕТЬИМИ ЛИЦАМИ)**
- MOD089V03 - ОТПЕЧАТАНО В СЕНТЯБРЕ 2015.



طورش عربلا قماعلا

- **تكلفة التغليف:** من ضمن السعر للماكينة - قطع الغيار والملحقات 5 يورو.
- **للطلبات التي لا تتجاوز سعر 80 يورو، التكلفة الثابتة لإدارة الطلبات هي 5 يورو.**
- **شروط الدفع:** يُطلب الدفع نقداً أو عند التسليم: 1. لمرات التوريد الأولى - 2. عند تجاوز رصيد القيد على الحساب - 3. لإرسال قطع الغيار.
- **الدفع بالتقسيط:** يجب تحديده.
- **الأسعار:** الأسعار ليست إجبارية أو ثابتة، يمكن أن تخضع للتعديلات ودون سابق إنذار، في هذه الحالات سيتم تحديدها عند الطلب. الأسعار لا تشمل قيمة الضريبة المضافة (I.V.A.).
- **مواعيد التسليم:** 1. شحن يومي للماكينات المتوفرة في المخزن - 2. 25 يوم للماكينات التي يجب إنتاجها باستثناء الظروف الطارئة.
- **الدعم الفني:** يتحمل البائع طوال فترة الضمان البالغة عام واحد. تلتزم فيمار (شركة مساهمة) Forcar srl بموجب الضمان بتوريد جميع مكونات قطع الغيار التي يثبت أنها معطوبة. سعر البيع الموضح في الفاتورة إلى المستخدم النهائي لا يتضمن فقط سعر المنتجات النهائية المباعة ولكنه يتضمن أيضاً إدارة الضمان الذي يغطي هذه المنتجات من جانب البائع. لن تتحمل فيمار (شركة مساهمة) Forcar srl أية تكلفة مباشرة أو غير مباشرة يتكبدها البائع مقابل إدارته للضمان.
- **التسليم في أرض المصنع:** تسافر البضاعة على مسؤولية وخطر طالبيها، لذلك لا تتحمل أية مسؤولية عن الأضرار التي تصيب البضاعة أثناء النقل. أية شكاوى أو اعتراضات يجب تقديمها عند استلام البضاعة وبموجب القوانين.
- **الضمان:** 12 شهر.
- **القائمة:** تلغي هذه القائمة جميع القوائم السابقة. البيانات الفنية المدونة في هذه القائمة هي إرشادية فقط. تحتفظ الشركة بحقها في تعديل المواصفات الفنية والجمالية أو إيقاف الإنتاج في أي وقت دون ضرورة إعطاء إي إنذار سابق.
- **جميع ماكيناتنا مؤمنة (المسئولية المدنية نحو أطراف ثالثة)**
- **ي من أ MOD089V03 عابطلا يف ريمتبس 2015**

FOOD PROCESSING EQUIPMENT
MULTISERVICE TROLLEYS
REFRIGERATED LINE
SNACK BAR EQUIPMENT

fimar
group

Noi ci mettiamo il

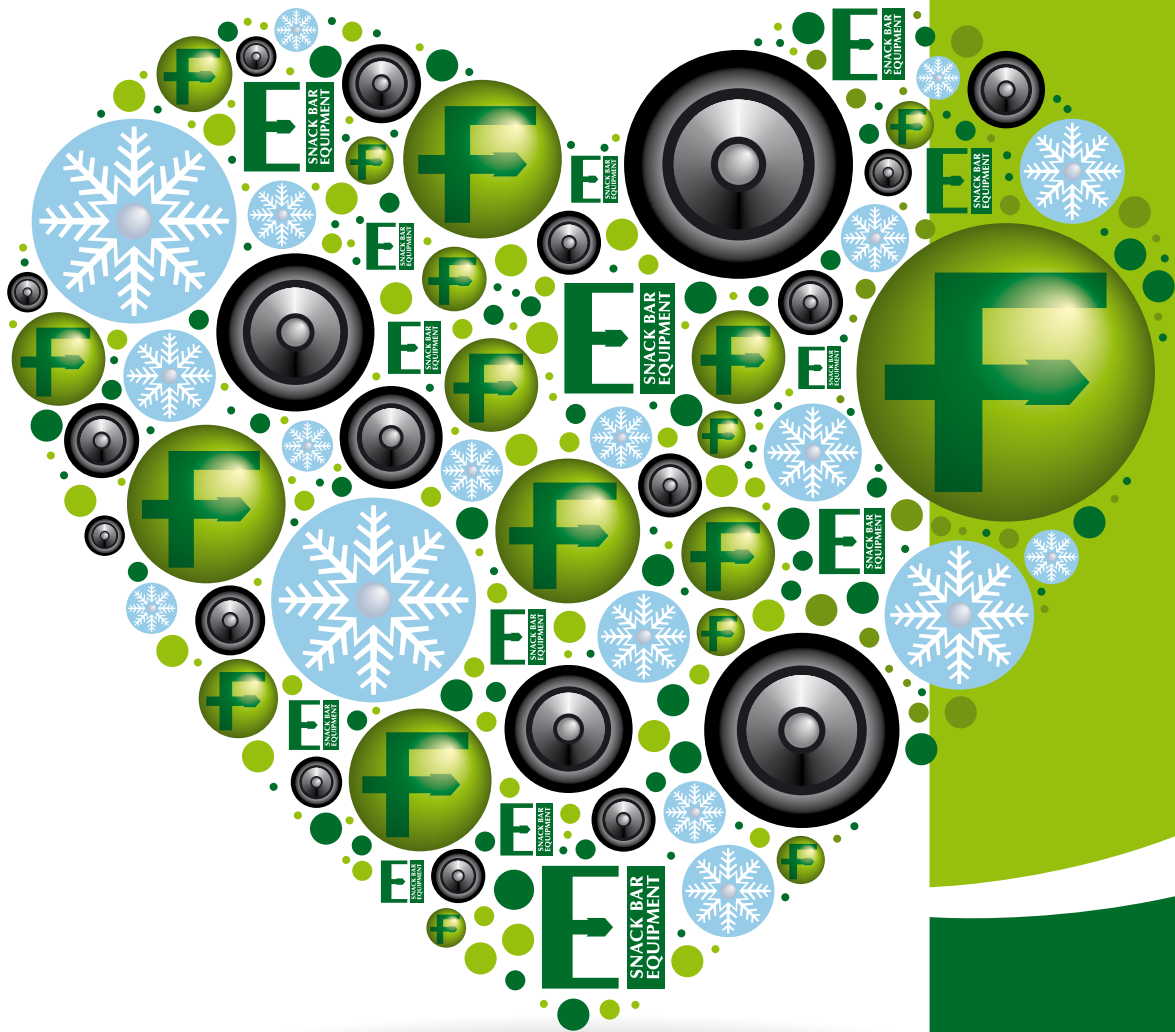

forcar®

Via S. Pertini, 14 - 47826 Villa Verucchio (RN) ITALY - www.forcar.it
Tel. +39 0541 670529 - Fax +39 0541 670064 - e.mail: mail@forcar.it

